

# RADIO NEWS

JANUARY  
1947  
35c



RN-56-J41366-47  
LAURENCE THORSON  
DALLAS WIS



# EMERGENCY

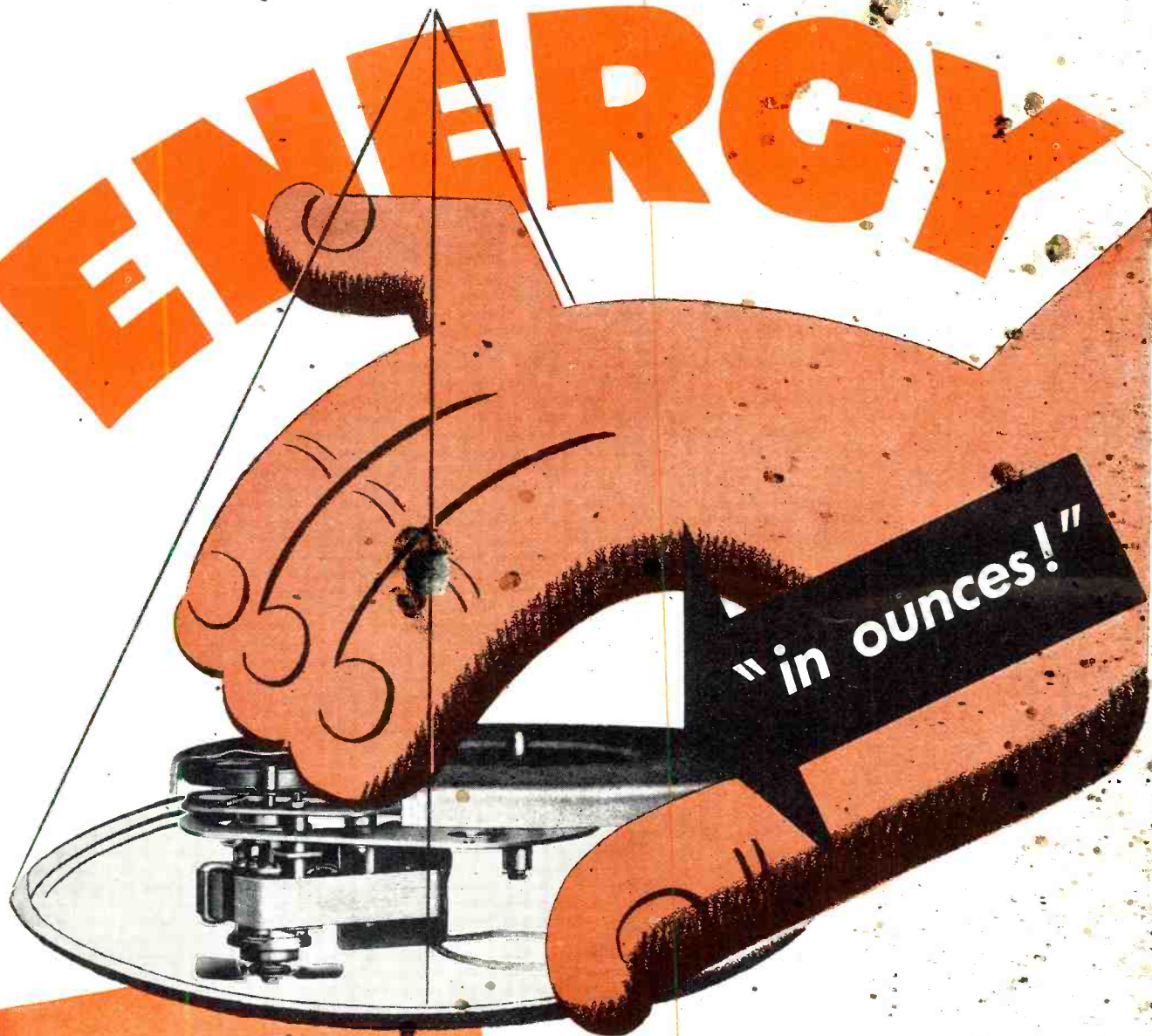

The famous Model 80 Even Speed Alliance Phonomotor operating on 110 or 220 volts is made for 40, 50 or 60 cycles, 16 watts input, 78 RPM. It has no gears—runs at an even speed—has a smooth, quiet, positive friction-rim drive. Ample proportioned bearings with large oil reservoirs assure long life. A slip-type fan gives cool operation—avoids any possible injury.

The Alliance Model K Phonomotor, a 25 cycle companion to the Model 80, operates on 110 volts, 25 cycles at 12 watt input. Motor and idler plate on Alliance phonomotors are all shack mounted to the cabinet mounting plate, to minimize vibration.

MINIATURE MOTORS THAT  
MAKE 'EM MOVE

- Light weight, compact, interchangeable power sources . . . small motors that can be mass produced at low cost are in rapidly growing demand! And Alliance has a "Head Start" in making millions of small electric motors.
- Alliance phonomotors drive most of the turntables, record changers and recorders for the radio-phonograph industry. And Alliance Powr-Pakt Motors rated from less than 1-400th h.p. up to 1-20th h.p. will drive fan blades, motion displays, projectors and actuate switches and controls!
- Write today . . . find out how Alliance Motors can help to drive your products to market!

WHEN YOU DESIGN—KEEP

# alliance

MOTORS IN MIND

ALLIANCE MANUFACTURING COMPANY • ALLIANCE, OHIO





# I Will Show You How to Learn RADIO by Practicing in Spare Time

**I Send You Big Kits of Radio Parts**

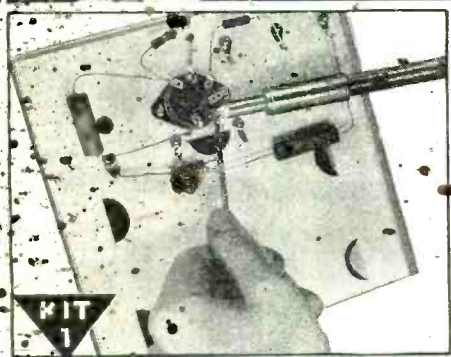

**KIT 1**

I send you Soldering Equipment and Radio parts; show you how to do Radio-soldering; how to mount and connect Radio parts; give you practical experience.

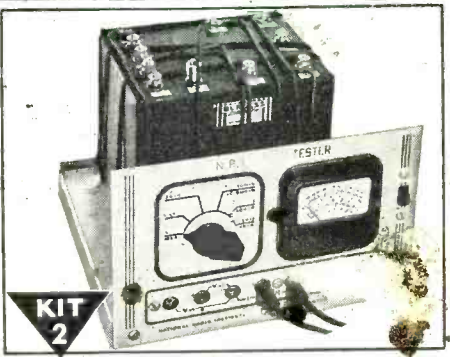

**KIT 2**

Early in my course I show you how to build this N. R. I. Tester with parts I send. It soon helps you fix neighborhood Radios and earn EXTRA money in spare time.

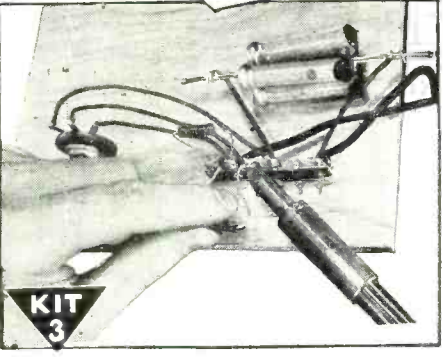

**KIT 3**

You get parts to build Radio Circuits; then test them; see how they work, learn how to design special circuits; how to locate and repair circuit defects.

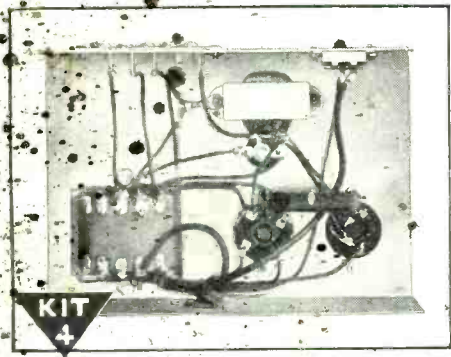

**KIT 4**

You get parts to Build this Vacuum Tube Power Pack; make changes which give you experience with packs of many kinds; learn to correct power pack troubles.

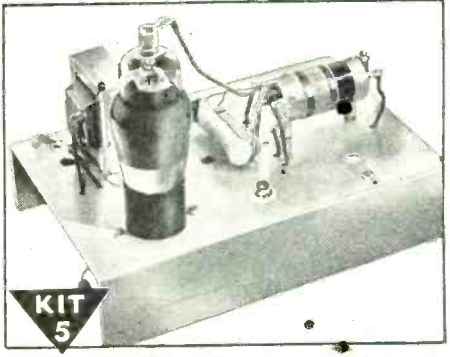

**KIT 5**

Building this A. M. Signal Generator gives you more valuable experience. It provides amplitude-modulated signals for many tests and experiments.

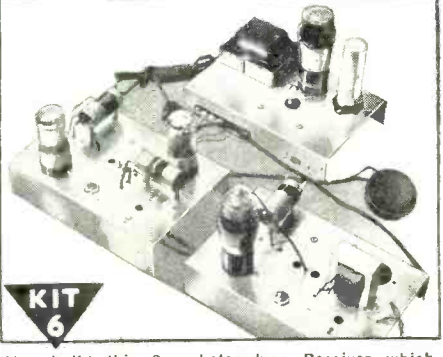

**KIT 6**

You build this Superheterodyne Receiver which brings in local and distant stations—and gives you more experience to help you win success in Radio.

## I Will Train You at Home - SAMPLE LESSON FREE

APPROVED for training under G.I. BILL

Do you want a good-pay job in Radio—or your own money-making Radio Shop? Mail Coupon for a FREE Sample Lesson and my FREE 64-page book, "How to Be a Success in RADIO—Television, Electronics." See how N. R. I. gives you practical Radio experience at home—building, testing, repairing Radios with BIG KITS OF PARTS I send!

Many Beginners Soon Make Good Extra Money in Spare Time While Learning

The day you enroll I start sending EXTRA MONEY JOB SHEETS. You LEARN Radio principles from my easy-to-grasp, illustrated lessons—PRACTICE what you learn with parts I send—USE your knowledge to make EXTRA money fixing neighbors' Radios in spare time while still learning! From here it's a short step

to your own full-time Radio Shop or a good Radio job!

**Future for Trained Men Is Bright in Radio, Television, Electronics**

It's probably easier to get started in Radio now than ever before because the Radio Repair business is booming. Trained Radio Technicians also find profitable opportunities in Police, Aviation, Marine Radio, Broadcasting, Radio Manufacturing, Public Address work. Think of even greater opportunities as Television and Elec-

tronics become available to the public! Send for free books now!

**Find Out What N. R. I. Can Do For You**

Mail Coupon for Sample Lesson and my 64-page book. Read the details about my Course. Read letters from men I trained, telling what they are doing, earning. See how quickly, easily you can get started. No obligation! Just MAIL COUPON NOW in an envelope or paste it on a penny postal. J. E. SMITH, President, Dept. 7AR, National Radio Institute, Pioneer Home Study Radio School, Washington 9, D. C.

Our 33rd Year of Training Men for Success in Radio

**Good for Both - FREE**

Mr. J. E. SMITH, President, Dept. 7AR, National Radio Institute, Washington 9, D. C. Mail me FREE, without obligation, Sample Lesson and 64-page book about how to win success in Radio—and Television, Electronics. (No salesman will call. Please write plainly.)

Age .....

Name .....

Address .....

City ..... State .....

(Please include Post Office zone number)



**My Radio Course Includes TELEVISION • ELECTRONICS FREQUENCY MODULATION**

APPROVED FOR TRAINING UNDER GI BILL

January, 1947

**For the SERVICEMAN-DEALER**

Your Shop Location.....	<i>Samuel C. Milbourne</i>	30
A New All-Purpose Signal Tracer.....	<i>Shephard Litt</i>	36
Crystal Diode Applications.....	<i>J. C. Hoadley</i>	43
Practical Radio Course.....	<i>Alfred A. Ghirardi</i>	44
RC Audio Oscillator.....	<i>J. T. Goode</i>	46
Be Sure of Quality Before You Sell.....	<i>M. Kenneth Brody</i>	51
Putting the New Small Meter to Work.....	<i>Rufus P. Turner, W1AY</i>	52
Home Constructed V.T.V.M.....	<i>J. H. Carlisle</i>	54
RN Circuit Page.....		62
Depreciation and Your Income Tax.....	<i>Harold J. Ashe</i>	112

**For the AMATEUR**

A Stabilized Modulated Oscillator.....	<i>Albert E. Hayes, Jr., W11IN/3</i>	28
A Breadboard 2 Meter Kilowatt Transmitter.....	<i>G. H. Floyd, W2RYT and H. D. Wells, W8LWD</i>	32
Experimental U.H.F. Oscillator.....	<i>C. W. Roeschke, W9PFB</i>	35
The Electroplex—A New Automatic Key.....	<i>Julian T. Dixon, W4AJY</i>	38
New Parasitic Beam Design.....	<i>R. G. Rowe, W2FMF</i>	40
Ring Oscillators for U.H.F. Transmission.....	<i>Tom Gootée</i>	48

**Of GENERAL INTEREST**

Radio Controlled Flight.....		25
Home Built TRF Receiver.....	<i>James W. Hoskins</i>	70
Radio News Index to Volumes 35-36.....		160

**DEPARTMENTS**

For the Record....	<i>The Editor</i>	8	What's New in Radio.....	64
Spot Radio News..	<i>Fred Hamlin</i>	12	Next Month.....	108
QTC.....	<i>Carl Coleman</i>	42	Manufacturers' Literature....	134
Short-Wave.....	<i>K. R. Boord</i>	56	Within the Industry.....	156
Technical Books.....		165		



**COPYRIGHT, 1947 ZIFF-DAVIS PUBLISHING COMPANY**  
185 N. Wabash Ave., Chicago 1, Ill.

BRANCH OFFICES: NEW YORK WASHINGTON. LOS ANGELES, TORONTO

Chairman of the Board & Publisher: **WILLIAM B. ZIFF**

President: **B. G. DAVIS**

Vice Presidents: **GEORGE BERNER** Advertising & Sales Director

**MICHAEL H. FROELICH** Editorial Director

**H. J. MORGANROTH** Production Director

**H. G. STRONG** Circulation Director

Secretary-Treasurer: **ARTHUR T. PULLEN** Art Director: **HERMAN R. BOLLIN**

Other Ziff-Davis Publications: Radio-Electronic Engineering, Plastics, Flying, Popular Photography

RADIO NEWS is published monthly by the Ziff-Davis Publishing Company, 185 N. Wabash Ave., Chicago 1, Ill. Subscription Rates: in U. S. and Canada \$4.00 (12 issues), single copies 35 cents; in Mexico, South and Central America, and U. S. Possessions, \$4.00 (12 issues); in British Empire, \$5.00 (12 issues)—all other foreign countries \$5.00 (12 issues). Subscribers should allow at least 2 weeks for change of address. All communications about subscriptions should be addressed to: Director of Circulation, 185 N. Wabash Ave., Chicago 1, Ill. Entered as second class matter March 9, 1938, at the Post Office, Chicago, Illinois, under the Act of March 3, 1879. Entered as second class matter at the Post Office Dept., Ottawa, Canada. Contributors should retain a copy of contributions and include return postage. Contributions will be handled with reasonable care but this magazine assumes no responsibility for their safety. Accepted material is subject to whatever revisions and by-line changes that are necessary. Payment made at our current rates, covers all authors', contributors', or contestants' rights, title and interest in and to accepted material, including photos and drawings.

**EDITORIAL**

**OLIVER READ, W9ETI**  
Editor

**WM. A. STOCKLIN**  
Asst. to the Editor

**H. S. RENNE, Ex. W8PTS**  
Technical Editor

**RAY FRANK, W9JU**  
Amateur Radio Editor

**PAUL H. WENDEL**  
Eastern Editor

**FRED HAMLIN**  
Washington Editor

**GAITHER LITRELL**  
Western Editor

**P. B. HOEFER**  
Assistant Editor

**ARTHUR E. HAUG**  
**WALTER STEINHARD**  
Staff Photographers

**E. H. SEHNERT**  
Chief Draftsman

**R. S. KUPLACK**  
Staff Artist

**ADVERTISING**

**L. L. OSTEN**  
Advertising Mgr.

**JOHN A. RONAN, JR.**  
Midwest Adc. Mgr.

**C. R. TIGHE**  
Manager Eastern Division

**WM. L. PINNEY**  
Manager Western Division



**COVER PHOTO**  
By **Arthur E. Haug**  
Staff Photographer

A typical Christmas scene in a home where children and adults alike received the cherished gift of a new radio. These lucky youngsters received a Motorola "Playmate, Jr." from Santa. This little portable is a 3-power, 5½ lb. unit made by Galvin Mfg. Corp.



hallicrafters PRESENTS THE

# SX-42

Another first!  
Greatest continuous frequency coverage of any communications receiver — from 540 kc to 110 Mc

This is the long-awaited Hallicrafters SX-42, a truly great communications receiver. The tremendous frequency range of the SX-42, *greater than ever before available in a receiver of this type*, is made possible by the development of a new "split-stator" tuning system and the use of dual intermediate frequency transformers. Packed with advance features that every ham and every other radio enthusiast desires, the SX-42 clearly lives up to the Hallicrafters ideal of "the radio man's radio."

From now on watch Hallicrafters — the name that's remembered by the veteran, preferred by the radio amateur. See your distributor for demonstration of the SX-42 and for colorful literature describing this great set in complete technical detail.



*Because of the precise and thorough engineering that must be done on the SX-42 and because the parts supply has not been continuous, top production peaks have not yet been reached. In the immediate future deliveries will necessarily run behind the demand, but the SX-42 is definitely worth waiting for.*

**\$250<sup>00</sup>**

Amateur Net

Adjustable Base for "eye-angle" tuning No. B-42 \$7.50 APPROXIMATE

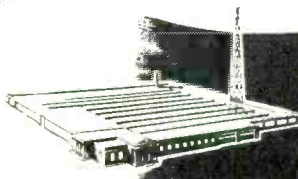

**hallicrafters RADIO**

THE HALLICRAFTERS CO., MANUFACTURERS OF RADIO AND ELECTRONIC EQUIPMENT, CHICAGO 16, U. S. A.

Sole Hallicrafters Representatives in Canada: Rogers Majestic Limited, Toronto-Montreal

BUILDERS OF *Skyfone* AVIATION RADIOTELEPHONE



# Sales Leadership

NATION-WIDE  
POPULARITY



FADA 5-tubes — plus-rectifier-tube models are equipped with the new FADA "Sensitive-Tone" ... assuring greater sensitivity and clearer reception.

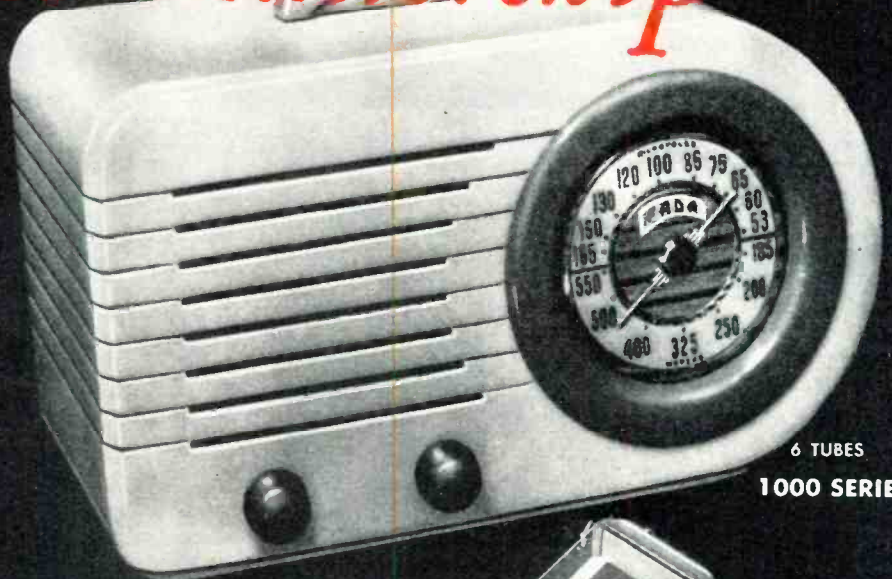

6 TUBES  
1000 SERIES

# FADA

Each of the new 1946 FADA models shows that high degree of national popularity—that amazing consumer sales appeal which indicates true leadership!

FADA leadership is based upon a 25 year record of performance — superior tone, superior beauty, superior engineering . . . plus 25 years of consistent national advertising and sales promotion.

FADA leadership is reflected in sales! For greater sales—this year, and next year and the years to come — you can depend on FADA — "the radio of tomorrow — today!"

YOU CAN ALWAYS DEPEND ON

# FADA Radio

*Famous Since Broadcasting Began!*

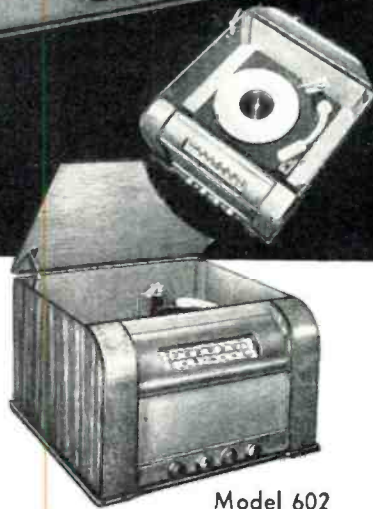

Model 602

New Superheterodyne AC Table Model Radio Phonograph Combination with Automatic Record Changer in a Cabinet of Beautiful Mahogany Veneers.



637 SERIES

Superheterodyne AC de luxe Portable Radio-Phonograph with Automatic Record-Changer.

FADA RADIO AND ELECTRIC COMPANY, INC., LONG ISLAND CITY, N. Y.



# NOW SPRAYBERRY RADIO TRAINING

## GIVES YOU 8 BIG KITS OF RADIO EQUIPMENT

WITH A COMPLETE 6 TUBE SUPER-HETERODYNE RECEIVER

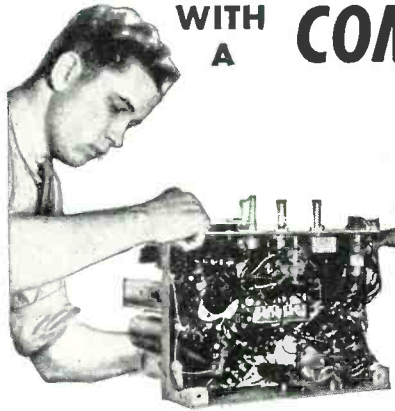

**YOU LEARN RADIO SERVICING THROUGH INTENSIVE "SHOP-BENCH" PRACTICE**

### YOU DO EXPERIMENTS, CONSTRUCTION, TROUBLE-SHOOTING

I'll show you how to perform over 175 instructive Experiments—how to build countless Radio Circuits. You'll learn a new, fast way to test Radio Sets without mfg. Equipment.



I give you a fine, moving-coil type Meter Instrument on Jewel Bearings—with parts for a complete Analyzer Circuit Continuity Tester. You learn how to check and correct Receiver defects with professional accuracy and speed.

You'll get valuable experience and practice building this Signal Generator and multi-purpose Tester. Makes a breeze out of fixing Radios and you don't have to spend money on outside, ready-made equipment.



Soldering, wiring, connecting Radio parts . . . building circuits with your own hands—you can't beat this method of learning. When you construct this Rectifier and Filter, Resistor and Condenser Tester, etc., you get a really practical slant on Radio that leads to a money-making future.

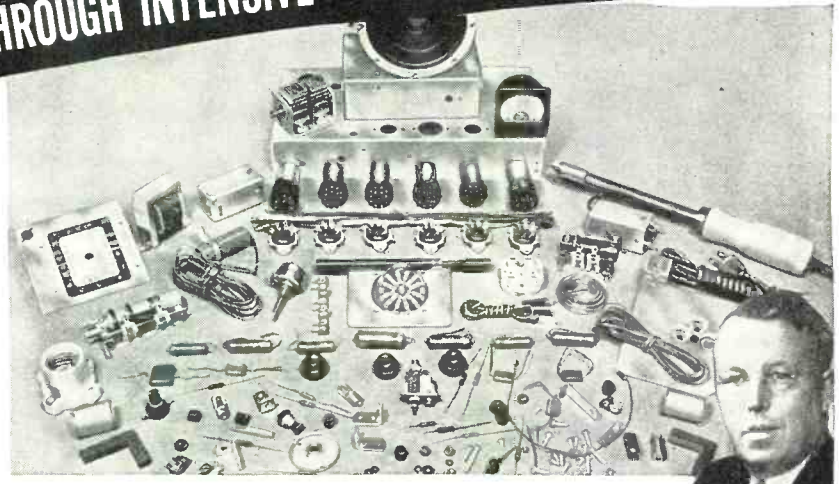

### HERE'S THE LATEST, SIMPLEST WAY TO TRAIN at HOME for a GOOD LIVING in RADIO-ELECTRONICS & TELEVISION

I train your mind by putting you to work with your hands on a big 6-Tube Superheterodyne Receiver. And, believe me, when you get busy with real Radio Parts—8 big Kits of them—you really LEARN Radio and learn it RIGHT! You get the practical stuff you need to be useful in Radio, and that's what it takes to make money. You don't have to worry about what to do with these 8 Kits of Parts. Step by step, I show you how to build circuits, test, experiment, trouble-shoot. And you don't need any previous experience. The Sprayberry Course starts right at the beginning of Radio! You can't get lost! Simplified lessons, coupled

with real "Shop" practice, makes every subject plain and easy to understand and remember.

#### A BUSINESS OF YOUR OWN . . . OR A GOOD RADIO JOB

Soon after you begin Sprayberry Training, I'll send you my sensational BUSINESS BUILDERS. You'll find out how to get and do neighborhood Radio repair jobs for nice profits and rich experience while learning. This sort of work can easily pave the way for a Radio Service business of your own. But with Sprayberry Training, you're not limited. You can swing into any one of the swiftly expanding branches of Radio-Electronics INCLUDING Radio, Television, FM, Radar, Industrial Electronics. Be wise! Decide now to become a fully qualified RADIO-ELECTRONICIAN. Get full details about my Training at once! Mail coupon below for my 2 big FREE Books.

### SEND FOR THESE FREE BOOKS



"How to Read Radio Diagrams and Symbols"

Here's a valuable and wonderfully complete new book which explains in simple English how to read and understand any Radio Set Diagram. Includes translation of all Radio symbols. Send for this volume at once! It's free! Along with it, I will send you another Big Free book describing in detail my Radio-Electronic Training.

**SPRAYBERRY ACADEMY OF RADIO**  
 F. L. Sprayberry, President, Room 2517, Pueblo, Colorado

Please rush my FREE copies of "How to MAKE MONEY in RADIO, ELECTRONICS and TELEVISION," and "HOW to READ RADIO DIAGRAMS and SYMBOLS."

Name ..... Age .....

Address .....

City ..... State .....

(Mail in envelope or paste on penny postcard)

**MAIL COUPON TODAY!**



★ for replacement of worn pre-war changers  
 ★ for constructing your own radio-phono combination

it's

**WEBSTER**  
 best known name in  
**RECORD CHANGERS**

When you replace your old, worn changer, or construct your own radio-phono combination—do as so many others have wisely done—choose Webster. Known for their high fidelity of reproduction, precision-made parts, and smooth, dependable performance, Webster Changers are truly "The Choice of Music Lovers."



Model 56

Shuts Itself Off after the last record has played! Plays "inside-out" or home recordings when in manual play position. Cushioned spindle protects records, Webster 4-pole, shaded pole motor, improved rim drive, feather-touch pickup, and simplified changer mechanism for long dependable service. All parts heavy gauge, copper or plated steel. Plays ten 12-inch or twelve 10-inch records. Dimensions: 14" x 14" x 9" overall (6½" above main plate, 2½" below.)



Model 50

Compact, Efficient, Model 50 is designed for use in smaller units where space is limited. It has the Webster two-tier bonded construction of changer mechanism, cushioned spindle, manual play position, improved rim drive, and feather-touch pickup. All parts are heavy gauge, copper-plated steel, and built for long dependable service. Plays ten 12-inch or twelve 10-inch records. Dimensions: 12" x 12½" x 9" overall (6½" above main plate, 2½" below.)



see your  
 dealer

The choice of music lovers

**WEBSTER CHICAGO**  
 5610 BLOOMINGDALE AVE.  
 CHICAGO 39, ILLINOIS

For the **RECORD.**

BY THE EDITOR

**S**INCE V-J Day independent radio service dealers have limped along on a starvation diet of tubes and replacement parts and have had but few new radio receivers to offer their customers. But they have been given an oversized stock of advice on how to run their businesses and have been oft told about their reputed failings.

We were talking with some dealers recently about a meeting they had attended where the speaker proclaimed that the radio manufacturer was not obligated to the radio serviceman in any way. He had said, in effect, that the manufacturer had *his* job to perform and the serviceman had *his* job to do. If the manufacturer cooked up some tricky innovation in a circuit, he wasn't obligated to tell the serviceman. It was up to the repair man to figure out that cunning little wrinkle when the receiver bobbed up in his shop for repairs.

These dealers too were talking about the flood of postwar radios that were already flowing into their shops for service. These sets are supposed to be those marvelous new postwar radios, brimming over with all of the improvements which wartime design and production genius had devised, according to the glowing picture painted by much wartime advertising, that is. They were damning brand-new receivers with unsoldered leads, with poor quality speakers where the slightest trace of damp weather caused the voice coil to kiss the pole piece with a raucous noise, of tubes that tested o.k. in the tube checkers, but wouldn't function in the set. They were fixing a lot of these postwar sets and trying to protect the "vaunted" reputations of many a first-line radio manufacturer.

The home radio industry has never appreciated nor recognized the important and indispensable contribution the independent radio serviceman has made to the radio industry. The average radio serviceman came into the business through a love for tinkering with radio circuits and a sincere desire to have a small business of his own. Usually he possessed little or no knowledge of business fundamentals or even an understanding of what makes a retail business click. He just set up shop, repaired whatever radios were brought in to him and hoped enough business would come in to keep the wolf from the door.

The radio receiver, without a circuit diagram or other information about the designer's peculiar innovations, can stop even the best radio service engineer unless he takes the time to analyze the assembly carefully, component by component. Yet, manufacturer after manufacturer threw re-

ceivers on the market without supporting technical information that would help the neighborhood serviceman to whom the purchaser would logically turn for help when the set failed to function. Eventually the circuit would appear in print, perhaps a year or two later, but this was of small help to the conscientious and hard working guy who had the set dropped in his lap for repairs three months after it was purchased.

The radio industry generally has failed to support this valuable arm of the radio business. As an industry, it has not supplied the service dealer with instructive material on basic circuit developments, components and replacements, tube performance data and anything helpful industrywise that would materially aid the independent dealer do a faster and better job of keeping the customer's radio set working—that is until an aggressive group of service specialists, recognizing the need for complete servicing data schematically, pictorially and practically, undertook the job. This independent organization analyzes every available model as fast as it leaves the makers' production lines and immediately prepares complete data now available to the serviceman at frequent intervals, even before many new models reach his establishment.

The novelty of radio in the early days materially influenced the buying public to pay for rapid obsolescence of expensive home receivers. It also generated some unsound thinking on the part of many radio manufacturers who are failing to see, even today, that the radio industry has grown up! Radio is no longer a fascinating novelty in the public eye and the days of "anything goes" are over. There is a growing public demand that the new radios they buy must not only perform far better than prewar sets, but they must also possess the stamina promised through wartime developments. This is also expected of FM, television and facsimile, as well as appliances sold today by many radio dealers.

Radio service dealers today are being criticized because they have failed to equip themselves to handle television servicing. But howinell can they—when the makers' service data remains "top secret"? There has been some talk that larger television manufacturers plan to handle their own television installations and servicing. One rumor recently heard was that a group of manufacturers planned to pool their service activities into one large service company that would handle the installation and servicing of all their TV receivers. We do not

(Continued on page 155)

RADIO NEWS



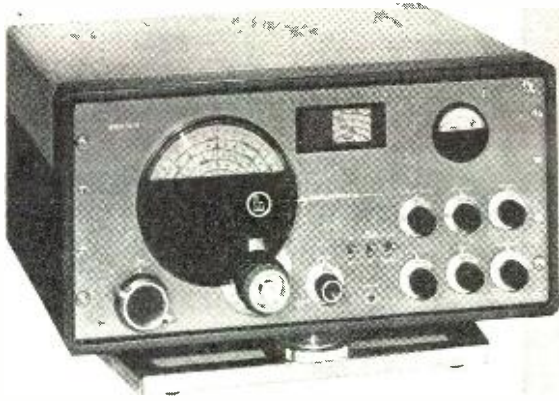

**NEW!**

**HALLICRAFTERS SX-42**

Here's the NEW SX-42—the receiver that sets a new standard in radio performance. Covers everything: Frequency range of 540 KC. to 110 MC. brings you high-fidelity broadcast reception—world-wide Short-wave coverage—PLUS true high-fidelity FM broadcast reception (all FM frequencies), and hi-fi phono reproduction. The new SX-42 is brilliantly designed to bring you more features, more operating thrills than you've ever thought possible. Wide-vision no-glare dials, AM-FM signal level meter, six-position selectivity control, dual IF system, separate sensitivity and volume control, NEW SIMPLIFIED controls for family use. Designed for top-flight reception—in the home, or for Amateur and Commercial communication work.  
**Net, less Speaker..... \$250.00**

# Order Your Communications Receiver from ALLIED

**You Get Earliest Delivery from ALLIED**

because ALLIED is the world's largest distributor of communications equipment. Naturally, we receive manufacturers' shipments quickly—and these shipments of highly diversified gear are completely centralized for faster handling. All this means that *you* get faster service on your orders—handled, of course, with customary ALLIED efficiency and expert attention. *Your orders to ALLIED are orders for earliest delivery.*

**Time Payments**

**Trade-Ins Accepted**

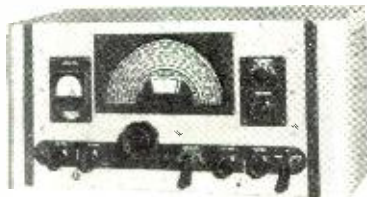

**THE RME 45**

The famous RME 45 Receiver delivers peak reception on all frequencies—550 to 34,000 KC. Features full-vision calibrated dial using a single control for two-speed tuning. Includes five Amateur bands with ample band-spread. Has DB-calibrated signal level meter; 5-step variable crystal filter; Automatic Noise Suppression; stable, variable-pitch beat oscillator, and a host of other features. Housed in handsome streamlined metal cabinet with matching speaker.  
**Net, with Speaker..... \$198.70**

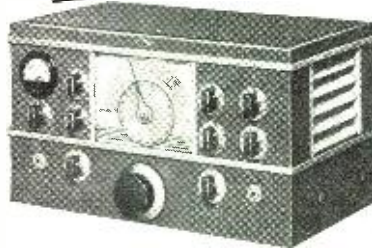

**NATIONAL NC-2-40D**

One of National's top receivers. Covers 490 KC. to 30 MC. range in 6 tuning bands. Has definite, accurate calibration for all bands. Features efficient single-dial control. Famous for its stable high frequency circuits. Frequency drift is reduced to a negligible value by temperature compensation. Has automatic band-in-use indicator. Wide-range adjustable series-valve-noise limiter. Flexible crystal filter. Special r.f. coupling circuits maintain full sensitivity.  
**Net, less Speaker..... \$225.00**  
 Speaker in matching cabinet, **Net. \$16.44**

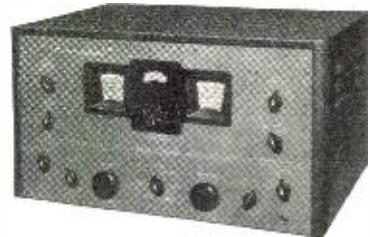

**HAMMARLUND HQ-129-X**

Designed to meet the most critical demands of professional operators. Full range, .54 to 31 MC. accurately calibrated. Has 4 calibrated Ham bands and one arbitrary scale. Variable selectivity crystal filter. Low-drift beat oscillator for code and locating stations. Antenna compensator. Voltage regulation. Automatic noise limiter. Compensated oscillator to reduce drift during warm-up. Earphone jack. Three i.f. amplifier stages. Two audio stages. Speaker supplied in matching metal cabinet.  
**Net, with Speaker..... \$173.25**

**Other Communications Receivers**

Hallicrafters 5-38.....	\$39.50	RME-84.....	\$98.70
Hallicrafters 5-40.....	79.50	RME VHF-152 Converter.....	86.60
Hallicrafters 5-36A.....	307.50	RME DB-20 Preselector.....	68.20
National NC-46.....	97.50	National HRO.....	274.35
NC-46 Speaker.....	9.90	Hammarlund 5PC-400X.....	342.00

Net F. O. B. Chicago. Prices subject to possible change.



**FREE! ALLIED'S Latest Catalog**

**ALLIED RADIO CORP., D. L. Warner, W91BC**  
**833 W. Jackson Blvd., Dept. 1-AA-7**  
**Chicago 7, Illinois**

Enter order for.....Model.....  
 Enclosed \$..... Full Payment  
 Part Payment (Balance C.O.D.)  
 Send full information on Communication Receivers and Time Payment Plan, without obligation.  
 Send FREE 1946 ALLIED Catalog.

Name.....  
 Address.....  
 City.....Zone.....State.....

# ALLIED RADIO

**Everything in Radio and Electronics**



# RADIO JOBBERS\*—DEALERS—SERVICE MEN

## HERE'S HOW Federal Helps You to Bigger Profits and Better Service, with the New Miniature Selenium Rectifier

Everybody benefits from Federal's miniature 5-plate selenium rectifier — the new replacement for rectifier tubes in all AC-DC radio receivers. Jobbers and dealers get a fast-moving item that will ring up added profits . . . radio repair men earn extra money and give better service . . . and the customer gets finer performance from his set.

Since the first announcement of these miniature rectifiers, the response has been tremendous — but

production is in full swing and you can still get all you want, when you want them.

And now, Federal offers you these three big sales-boosters, to help you cash in on this new market. They're free with every order, even if it's for only one standard package. But the supply of these sales helps is limited, so be sure to send for yours today! Simply fill in and return the coupon below.

**\*RADIO JOBBERS** — these "sales promoters" will help you to build up a big demand for this new radio component. And Federal welcomes inquiries regarding territories now available for jobbers and sales representatives to handle the new Miniature Rectifier.

### 1. FREE SALES-CREATING WINDOW POSTER



This big 17-by-22 inch, 3-color poster, mounted on your window, wall, or counter, will let prospects know that you have this remarkable new rectifier for sale. It gives all the sales points at a glance — the facts that will turn prospects into customers.

### 2. FREE SELF-SERVICE COUNTER DISPLAY



Each standard package of 12 rectifiers opens up into this striking 3-color "self-service" counter display — an automatic salesman that makes it easier for your customers to buy. And every rectifier unit is individually boxed in an attractive carton. They stack neatly on your shelves and take up very little space.

# Federal Telephone and Radio

In Canada:—Federal Electric Manufacturing Company, Ltd., Montreal.

Export Distributors:—International Standard Electric Corp. 67 Broad St., N.Y.C.





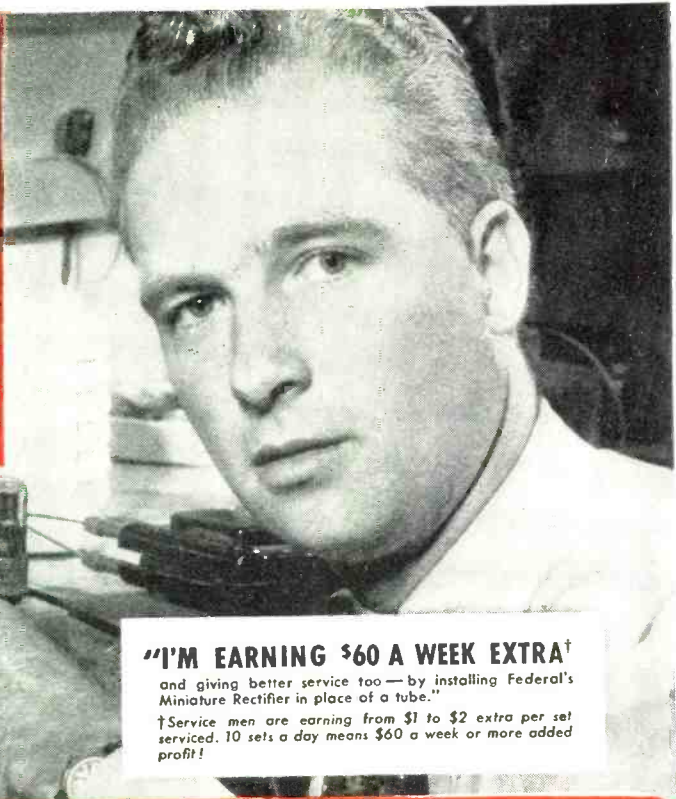

**"I'M EARNING \$60 A WEEK EXTRA†**

and giving better service too — by installing Federal's Miniature Rectifier in place of a tube."

†Service men are earning from \$1 to \$2 extra per set serviced. 10 sets a day means \$60 a week or more added profit!

### 3. FREE "HOW-TO-DO-IT" SERVICE MANUALS

Seven valuable service manuals, including an instructive 8-page booklet which gives simple, step-by-step directions for installing Federal's miniature rectifier in place of a tube. "Before-and-after" circuit diagrams, plus detailed photographs, show what to do and how to do it. You'll be surprised to find how easy it is.

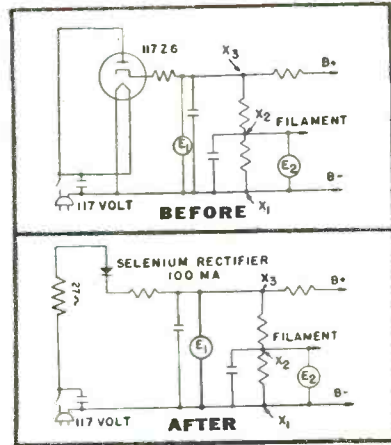

Circuit diagrams showing installation of miniature rectifier in a Motorola "Playmate."

**ORDER YOUR FEDERAL  
MINIATURE RECTIFIERS TODAY—  
SHIPPED BY RETURN MAIL**

# Corporation

Newark 1,  
New Jersey

January, 1947

**FEDERAL TELEPHONE AND RADIO CORPORATION**  
200 Mt. Pleasant Ave., Newark 4, N. J.

Dept. F959

Yes, Federal — I want to cash in on your offer. Send me number of packages checked below plus complete sales accessories. ( check or  money order enclosed)

**SELENIUM RECTIFIER, 403D2625, 100 Ma**

QUANTITY	PRICE*	
<input type="checkbox"/> 1 Package (12 Rectifiers) . . . . .	\$12.00	No order accepted for less than one package.  *Excludes state and City Use and Sales Taxes.
<input type="checkbox"/> 4 Packages (48 Rectifiers) . . . . .	48.00	
<input type="checkbox"/> 8 Packages (96 Rectifiers) . . . . .	89.28	
<input type="checkbox"/> 12 Packages (144 Rectifiers) . . . . .	129.60	

SHIP TO \_\_\_\_\_  
STREET \_\_\_\_\_ CITY \_\_\_\_\_ STATE \_\_\_\_\_



Designed for



Application

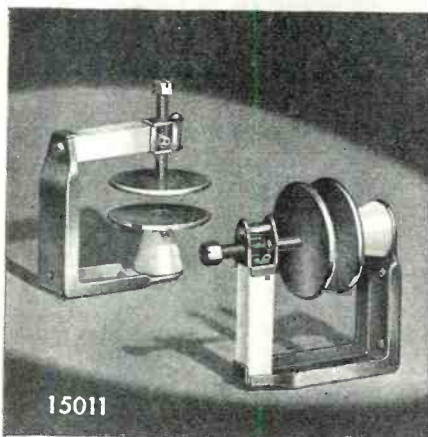

15011

### Disc Type Neutralizing Capacitor

Designed originally for use in our own No. 90881 Power Amplifier, the No. 15011 disc neutralizing capacitor has such unique features as rigid channel frame, horizontal or vertical mounting, fine thread over-size lead screw with stop to prevent shorting and rotor lock. Heavy rounded-edged polished aluminum plates are 2" diameter. Glazed Steatite insulation.

**JAMES MILLEN  
MFG. CO., INC.**

MAIN OFFICE AND FACTORY  
**MALDEN  
MASSACHUSETTS**



# Spot Radio News

★ Presenting latest information on the Radio Industry.

By **FRED HAMLIN**  
Washington Editor, RADIO NEWS

**PRODUCTION TRENDS** during the coming year will be toward quality and away from quantity, late-1946 market conditions indicated. Even before OPA ceilings were off table sets, supply was far enough ahead of demand to result in price wars in some metropolitan areas. At year-end, small-model inventories in retail outlets were ample. It follows that new-year production programs will accent console sets. Lagging items—FM-AM receivers, radio-phonograph combination consoles, and television sets—were beginning to perk up even early last fall, and should make the headline production story when the score is in for 1947. But don't discount the importance of table sets in the '47 market. They'll be evident in large numbers in the FM-AM field, and welcome to them. FM stations are particularly eager to see the small sizes in big production to build a listening audience large enough to attract advertisers.

**FIRST BREAK** in television production was dramatic—during September, 3242 units were turned out, as contrasted with a total of 225 for the previous eight months. Other items moved upward, receivers with FM facilities totalling 17,541 as compared with 13,892 in August. Console combinations hit a new high of 105,344—ahead of the same month in 1941, corresponding pre-war period. Two of the chief blocks to big production seemed on the way to elimination, with an increased supply of lumber and gang condensers coming off the fall production lines. More of the big sets appeared monthly in the fall and early winter, and indications are that '47 would be a banner year.

**THE NEW YEAR** will certainly be significant so far as television broadcasting is concerned. Latest available figures indicate that a total of thirty-seven stations should be broadcasting before mid-year, with more than forty additional applications under consideration at the Federal Communications Commission . . . FCC also began early in December to consider the problem brought up by commercial color television stations and the technical assets of this kind of equipment. *Columbia Broadcasting System* is behind this one and seeks permission to operate in the

band 480 to 920 megacycles. Enthusiasts for color predict wide use of the media for outdoor as well as studio picture-casts, day or night.

**NOT TO BE OVERLOOKED** in the radio fireworks for '47 are FM broadcasting activities, which promise plenty of excitement—and competition. Reports from the field indicate that any FMer who is on the air and in full swing by mid-year will be lucky, but from then on the going should be good. Chief causes for delays are two—set production will not catch up with demand for at least six months, and most new stations are having difficulty finding good broadcasting sites—high land is essential. Production promises to be on the way to catching up with demand by mid-year and experts are predicting that as many as 30 per-cent of the listener audience will be confirmed FM enthusiasts by January, 1948.

**STATION COMPETITION** promises to be stiff in highly concentrated population areas. FCC has pending a high of thirteen FM applications in the New York City area, Chicago is second with twelve, Los Angeles has asked for ten, Boston, Cleveland, and Washington eight, Pittsburgh and Indianapolis seven. A few stations are already on the air. Commercially, even ones that are yet to open report ready acceptance from advertisers. Time has been sold for WRCM, New Orleans, and KOPY, Houston; also for projected stations at Allentown, Pa., and Evanston, Illinois. Best advertising slogan comes from KOZY, Kansas City pioneer station: "FM Means Folding Money—for You."

**ADVERTISING** in the FM field already shows signs of jumping into the battle between FCC and the AM networks on the length and quality of advertising blurbs. The FM boys show signs of siding with FCC in the battle. Typical is an announcement by WQQW, FM-AM outlet operating in the Washington area. "No commercials will be permitted longer than one minute," says station policy. "At least fourteen minutes free of advertising will proceed and fourteen minutes of free advertising will follow each commercial." Admitting that "the majority of listeners are enthusiastic

**RADIO NEWS**



THEY'RE BETTER THAN EVER

*and they cover  
every requirement*

**1** Better impregnation  
to eliminate moisture

**2** Better hermetic seal-  
ing for longer life

**3** Quality control during  
manufacture



## MALLORY PAPER TUBULARS

YOU want quality in the paper tubulars you buy — of course! Otherwise your replacement work won't stand up. Mallory gives you the quality you want.

But Mallory gives you quantity, too. Quantity in a wide assortment of ratings

and sizes that meet all requirements that come your way.

That's the story in a nut shell — whether you're looking for wax impregnated cardboard tubulars or oil impregnated ones. The Mallory Catalog and your Mallory Distributor both prove that —

➔ YOU EXPECT MORE AND GET MORE... FROM MALLORY

**P. R. MALLORY & CO. Inc.**  
**MALLORY**

VIBRATORS... VIBRAPACKS\*... CAPACITORS... VOLUME  
CONTROLS... SWITCHES... RESISTORS... FILTERS  
... RECTIFIERS... POWER SUPPLIES. ALSO MALLORY  
DRY BATTERIES, THE ORIGINAL MERCURY BATTERIES.

\*Reg. U. S. Pat. Off.

**APPROVED PRECISION PRODUCTS**

**P. R. MALLORY & CO., Inc., INDIANAPOLIS 6, INDIANA**





The new addition to our  
 plant provides increased  
 production facilities to  
 enable us to fill the  
 backlog of orders  
 now on hand

EXPORT DEPARTMENT:  
 1791 Howard Street, CHICAGO 26, U. S. A.  
 Cable Address: MERIT



**MERIT COIL & TRANSFORMER CORP.**

TELEPHONE  
 4427 North Clark St. Long Beach 6311 CHICAGO 40, ILL.

**SPOT RADIO NEWS**

about commercial radio as it is," the station reports that "a minority—roughly one-third of the population—is dissatisfied with excessive commercialism" and proposes to "appeal particularly to advertisers seeking to reach that audience."

Quality of advertising copy will also be reviewed before it goes on the air. "The station will seek to insure that the products advertised, the claims made, and the advertising copy used will conform to the station's policy to reach "intelligent listeners." . . . If all this seems to be words from the mouth of FCC, it is perhaps worth adding that general manager at WQQW is Edward M. Brecher, from 1941 to 1945 assistant to FCC chairman James Lawrence Fly and subsequently a special analyst in FCC's law department. But the station's policy perhaps indicates a significant trend—FM's determination to bring advertising quality up to the quality of FM broadcasting. Whether it will succeed is one of the interesting \$64 radio questions that may be answered in 1947.

**NON-PROFIT FM STATIONS** will also figure in the broadcasting new deal. More than sixty educational institutions are already licensed, have received initial authorization or have applied to operate non-profit stations as this goes to press. Six stations are already on the air. Indications are that most states plan to establish networks linking county and municipally operated stations into state-wide systems. The early-bird interest of schools and colleges in the new radio equipment came as no surprise to FCC—educational institutions, it reports, were among the pioneers in broadcasting, at witness WHA of the University of Wisconsin, oldest university-operated station, which has furnished uninterrupted service for a quarter of a century. . . .

**WASHINGTON** may become national headquarters for FM broadcasters, following preliminary meetings there this fall and early winter toward organizing into an association. As this goes to press, major policies were being worked out to formalize the group and decide how wide to set the scope of its membership. That the new outfit will not be lacking in enthusiasm is indicated by a recent statement by Everett M. Dillard, KOZY head in Kansas City and also licensee for WSDC, Washington. Said Mr. Dillard: "If I were to tell you of a new atomic propelled automobile which would replace our present gasoline propelled type of vehicle, you would be startled and aware of a new era in transportation. FM, so far as radio is concerned, is to AM what atomic power in the automobile would be to gasoline power. Nothing can stop it!"

**FM PROGRAMMING** is one of the most serious problems on the immediate horizon. Chief hope of new station  
*(Continued on page 18)*



Now IN YOUR OWN HOME *Learn*

# RADIO ELECTRONICS

*The Practical*  
 "HOME-TESTED"  
*Modern "A-B-C" Way*



YOU USE ALL OF THESE RADIO PARTS  
 TO BUILD AND OPERATE  
**7**  
 DIFFERENT RADIO RECEIVING CIRCUITS

WITH THE HELP OF

**A** EIGHT Big Kits of Actual "Learn-by-Doing" Radio Parts and Assemblies with which you make 133 fascinating SHOP METHOD EXPERIMENTS in your own home! Imagine building 7 different Radio Receivers that operate!

**B** A 16 mm Home Movie Projector and Twelve Reels of "Learn-by-Seeing" Home Movie Films . . . for picture-clear, fast understanding of Radio Fundamentals!

**C** Modern, well-illustrated, Loose-leaf Lessons, prepared in clear, simple, understandable language . . . to guide you throughout your training!

**NO PREVIOUS RADIO OR ELECTRICAL EXPERIENCE NECESSARY**

DeForest's Training, Inc. provides every major home study aid to help you learn Radio-Electronics rapidly and thoroughly . . . to give you the experience and confidence needed for a responsible, Good-Pay Job, or to Start a Business of Your Own! Here is a REAL opportunity field for YOU . . . when you are a trained Radio-Electronics man! Just think of the tremendously exciting future ahead of FM Radio, Aviation and Broadcast Radio, Sound Motion Picture Equipment, Servicing and Sales of Radio Equipment, etc. Put yourself in this picture . . . See how you can benefit from a PRACTICAL training in this fascinating work! Think, too, of the coming possibilities ahead of Radar, Facsimile and Television. Send TODAY for the interesting, opportunity-revealing book, "Victory for You!" See how others probably no more talented or ambitious than you, have advanced in earning power after this training . . . how YOU can do it too! Mail the coupon NOW!

INCLUDING:

1. Simple Receiver
2. Two Tube Receiver
3. Tuned Radio-Frequency Receiver
4. Short Wave Receiver
5. Aviation Band Receiver
6. 4-Tube Superheterodyne
7. 5-Tube Superheterodyne with Magic Tuning Eye

... PLUS SCORES OF OTHER FASCINATING, INSTRUCTIVE RADIO-ELECTRONIC EXPERIMENTS

THEN GET THE HELP OF OUR EFFECTIVE EMPLOYMENT SERVICE



16 MM MOVIE PROJECTOR  
 YOU USE "LEARN-BY-SEEING" MOVIES

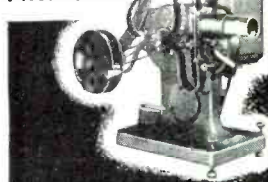

DEFOREST'S TRAINING, INC. INCLUDES INSTRUCTION IN MOTION PICTURE SOUND EQUIPMENT, FM RADIO AND TELEVISION . . . RESIDENTIAL TRAINING IN OUR MODERN CHICAGO LABORATORIES ALSO AVAILABLE—ASK US FOR INFORMATION!

**VETERANS!**

Big things are happening at DeForest's Training, Inc. for veterans! See how you can prepare yourself WITHOUT COST for a GOOD JOB or a BUSINESS OF YOUR OWN in the vast Radio-Electronic opportunity field.

**DeFOREST'S TRAINING, INC.**  
 CHICAGO 14, ILLINOIS

E. B. DEVRY, President  
 DeFOREST'S TRAINING, INC.  
 2535-41 North Ashland Ave., Dept. RN-D1  
 Chicago 14, Illinois, U.S.A.

Send FREE "VICTORY FOR YOU!" BOOK, showing how I may make my start in Radio Electronics.

Name \_\_\_\_\_ Age \_\_\_\_\_

Address \_\_\_\_\_ Apt. \_\_\_\_\_

City \_\_\_\_\_ Zone \_\_\_\_\_ State \_\_\_\_\_

If under 16, check here for special information.

If a discharged Veteran of World War II, check here.



# I'LL HELP YOU TO EQUIPMENT EVER

**ALFRED A. GHIRARDI**  
the man who has started thousands of students on successful careers by making Radio-Electronics easy to learn.

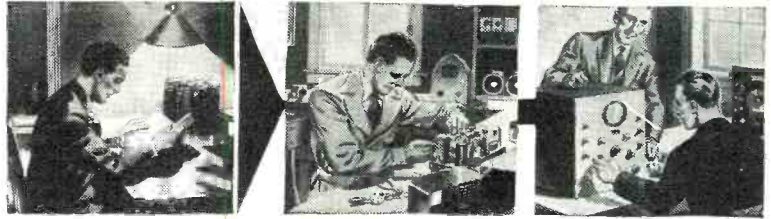

A FEW NIGHTS OF **THIS** CAN PAVE THE WAY TO A **THIS** PROSPEROUS FUTURE OF **THIS**

## Ghirardi's COMPLETE BASIC RADIO-ELECTRONIC TRAINING for beginners

for only \$5 (\$5.50 foreign).

5-DAY, MONEY-BACK GUARANTEE is your absolute protection. If you don't like RADIO PHYSICS COURSE you don't need to keep it. You cannot lose!

**NO PREVIOUS TRAINING NEEDED**  
36 Big Courses in One

Here are a few of the things about which RADIO PHYSICS COURSE teaches you:

- |                       |                        |
|-----------------------|------------------------|
| Sound, Speech, Music  | Detector & Amplifier   |
| Electron Theory       | Tube Action            |
| Electric Current      | Radio-Frequency        |
| Electric Circuits     | Amplifiers             |
| Resistance            | Superheterodynes       |
| Batteries             | Audio Amplifiers       |
| Electromagnetism      | Power Supplies         |
| Electromag-Induction  | Loud Speakers          |
| Condensers, Coils     | Auto & Aircraft Radio  |
| Alternating Currents  | Aviation Radio         |
| Transformers          | Public Address Systems |
| Filters               | Phototubes, Cathode    |
| Measuring Instruments | Ray Tubes              |
| Radio Waves           | Sound Pictures         |
| Vacuum Tubes          | Television, etc., etc. |

No matter what part of ELECTRONICS-RADIO-TELEVISION work you plan to enter, a knowledge of basic fundamentals is absolutely essential. Ghirardi's world-famous 972-page RADIO PHYSICS COURSE gives exactly the training you need—at a price you can afford to pay! If broken into "course" form and sent as monthly lessons, you'd regard it as a bargain at \$50 or more! Instead, you buy it for only \$5—and you progress as fast as spare reading time permits. Many have completed it in only a few weeks! Actually, this big, 4 lb. book has given more beginners their start in Radio-Electronics than any other book or course!

Ghirardi's RADIO PHYSICS COURSE starts your training at the very beginning—with Basic Electricity. Then it takes you step by step through the entire field of RADIO-ELECTRONICS-TELEVISION to the most modern developments. Nothing is omitted or condensed. Everything is explained as simply as A-B-C. You can understand every word of it without previous radio training of any kind. Ask any Radio-Electronic man. He'll know the book—because he probably trained from it himself! Get started now in Radio! Get started right! Our

RADIO PHYSICS COURSE is more widely used for home study and was more widely used for Signal Corps and Navy wartime training than any other book of its kind.

## LEARN ELECTRIC MOTOR REPAIR!

Train for Big Pay in a Field That Isn't Crowded  
—Just the Thing for Radio Men

There's big money in motor repair work! Prices are good. The field is not crowded. The home appliance repair business is a vast one and motor service is a highly important part of it. **ELECTRIC MOTOR REPAIR** by Robert Rosenberg is the book that will train you easily and quickly—for only \$5 complete!

**ELECTRIC MOTOR REPAIR** explains every detail of motor trouble diagnosing, repair and rewinding. Covers a-c and d-c motors, synchronous motors, and generators and BOTH mechanical and electrical control systems. Quick reference guides show exactly how to handle specific jobs.

Based on what can be learned from

this big book alone, you can train yourself quickly for PROFITABLE motor repair service. Ideal for beginners. Unexcelled for actual bench use in busy shops. Every type of work is demonstrated VISUALLY by more than 900 easily-understood diagrams. Unique Duo-Spiral binding arrangement divides book into two sections. BOTH text and related pictures can be seen AT THE SAME TIME. Lies open flat on the bench while you work. Contains 580 pages. Only \$5 complete.

Send coupon now. Practice from **ELECTRIC MOTOR REPAIR** for 5 full days. Then, if not more than satisfied, return book to us and your money will be cheerfully refunded.

**NEW - DIFFERENT - EASY TO UNDERSTAND**

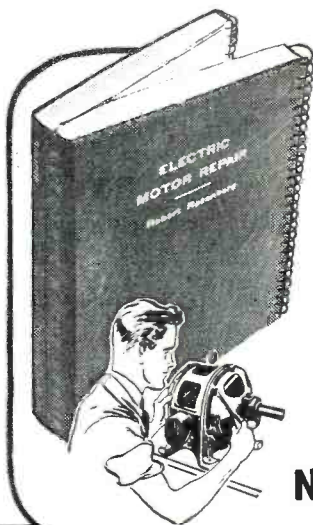

### The Fascinating Story of HOW RADIO GREW UP

... and of the men who helped it grow.

**NEW!**  
**JUST!**  
**OUT!**

No story of scientific progress is more exciting than this one. None has ever been told in a more interesting way than

Donald McNicol's **RADIO'S CONQUEST OF SPACE** now being offered for the first time. It is the story of men—amateurs, tinkers and famous scientists—who wrenched from the Universe one of its greatest secrets. It tells what they did and how they did it in piecing the gigantic Radio jigsaw puzzle together. **RADIO'S CONQUEST OF SPACE** is not only a book to be read for fun. Equally important, you'll find in it a wealth of background knowledge invaluable to all radio men and experimenters. Contains 347 pages and dozens of illustrations. Only \$4 complete. Use coupon.

# GHIRARDI TRAINING TO SAVE YOU LEARN EASIER, BETTER, FASTER...



# REPAIR ANY RADIO-ELECTRONIC MADE . . . AND GUARANTEE TO REFUND EVERY CENT OF YOUR MONEY IN FIVE DAYS IF YOU'RE NOT SATISFIED!

## THIS 4½ LB. HANDBOOK SHOWS EXACTLY HOW TO REPAIR OVER 4,800 RECEIVER MODELS

*A Definite, Dependable Guide for Diagnosing, Locating and Repairing the Common Troubles in Almost Every Receiver Ever Made*  
**GHIRARDI TELLS YOU WHAT TO DO—EXACTLY HOW TO DO IT**

Whether you repair radios for a living or work with them only occasionally, Ghirardi's **RADIO TROUBLESHOOTER'S HANDBOOK** will help you do the jobs better **AND TWICE AS FAST**. Eliminates useless testing! Saves time—helps you make more money! When a receiver comes in for repairs, simply turn to the 104-page Case History section. Look up the notes on that make and model. Chances are, you'll find **EXACTLY** the information you require. The Handbook tells what the trouble is—how to remedy it. Ideal for training and speeding up the work of new service helpers—handling tough jobs in half the usual time—repairing cheap sets rapidly.

### NOT A "STUDY" BOOK

The tabulations on hundreds of additional pages give you invaluable data on Color Codes, Tubes, I-F alignment and transformer troubles, tube substitutions, etc., and the literally dozens of charts, graphs, diagrams, data and helpful hints will save you money every day you use them!  
 "Thanks to Ghirardi's Handbook, I repaired my

radio in one hour after it had been returned as 'unrepairable' from a local shop," writes J. L. Fizzell, Kansas City, Mo.

"I would not take ten times the price my Handbook cost me," says C. E. Daniels of Florida.

"Started to work for me the first day I bought it. The Case Histories take you right to the trouble and save headaches and hours of testing," says Julius Siske, Jr., Curtis Bay, Maryland.

Ghirardi's big Handbook weighs 4½ lbs., contains 744 big manual-size pages. Only \$5 complete—on our 5-Day Money-Back Guaranteed offer!

### STOP GUESSING MISTER!

Don't guess! Don't waste time! Turn to Ghirardi's big Radio Troubleshooter's Handbook—let it tell you in a jiffy **WHAT** to do and **HOW** to do it.



**Only \$5 complete**  
 (see money-saving offer in coupon)

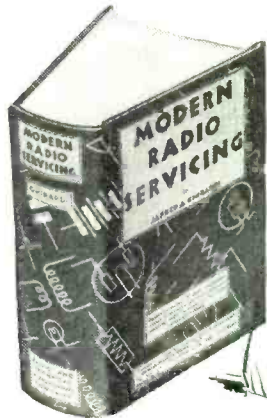

## GET A COMPLETE MODERN Professional SERVICE TRAINING . . . at Home Without an Instructor

Now, as never before, the call is for **PROFESSIONALLY TRAINED** men who really **KNOW** radio repair work.



A. A. Ghirardi's **MODERN RADIO SERVICING** is the finest, most complete instruction book on Radio-Electronic service work for either the novice or the professional serviceman—bar none! Actually, it gives a **COMPLETE MODERN EDUCATION** in truly professional service work of the kind that will be your "Open Sesame!" to the real opportunities in Radio-Electronic servicing springing up on every side. Remember! The call is now for **HIGHLY TRAINED** men having a broad knowledge of modern test equipment and testing techniques—**NOT** for "screw-driver" mechanics of limited technical understanding!  
 Read from the beginning. **MODERN**

**RADIO SERVICING** is a complete servicing course from A to Z. Used for reference, it is an invaluable refresher course on any type of work that puzzles you. Explains all types of test instruments used in Radio-Electronic service work—also how, when, why and where to use each one; how to make preliminary trouble checks and perform circuit analysis; how to repair or replace parts or make substitutions—and literally hundreds of additional subjects, including **How to Start and Operate a Successful Service Business of Your Own**. 1300 pages, 706 clear illustrations, 720 self-test review questions.

**Only \$5 complete**  
 (See money-saving offer in coupon)

### START A SERVICE BUSINESS . . . OR, GET A BETTER-PAYING JOB!

There's a real future for you in servicing—and A. A. Ghirardi's **MODERN RADIO SERVICING** is just the book to start you on it without delay. And remember: Radio itself only represents the beginning of this big book's usefulness to you. What it teaches you about Radio Servicing, Test Instruments and Modern Scientific Technical Procedure is exactly the training you need to fit you to "grow up" with the fast-expanding Electronics profession in all of its servicing phases.

The amount of Radio and Electronic equipment that will be manufactured and sold both to industry and the public within the next few years will be tremendous. All of it must be serviced—and there'll be rich rewards for competently trained men who can fill the bill!

**MODERN RADIO SERVICING** gives you real Professional service training—complete in every respect—easy to understand—and priced at only \$5 complete!

## FIVE DAY UNRESTRICTED MONEY BACK GUARANTEE

**MURRAY HILL BOOKS, Inc., Dept. RN-17**  
 232 Madison Ave., New York 16, N. Y.

- Enclosed find \$\_\_\_\_\_ for books checked; or,  send C. O. D. (in U.S.A. only) for this amount plus postage. In either event, I may return the books for refund of my money within 5 days if not fully satisfied.
- RADIO PHYSICS COURSE** \$5 (\$5.50 foreign)
- MODERN RADIO SERVICING** \$5 (\$5.50 foreign)
- MONEY-SAVING COMBINATION OFFER:** Modern Radio Servicing and Troubleshooter's Handbook—both big books—\$9.50 (\$10.50 foreign)
- RADIO TROUBLESHOOTER'S HANDBOOK,** \$5 (\$5.50 foreign)
- ELECTRIC MOTOR REPAIR** \$5 (\$5.50 foreign)
- RADIO'S CONQUEST OF SPACE** \$4 (\$4.50 foreign)

Name \_\_\_\_\_ State \_\_\_\_\_  
 Address \_\_\_\_\_  
 City & Dist. No. \_\_\_\_\_

**MONEY-SAVING COMBINATION**  
 Make your servicing library complete! Get BOTH Ghirardi's **RADIO TROUBLESHOOTER'S HANDBOOK** and **MODERN RADIO SERVICING** at the special Money-Saving Combination price of only \$9.50 for both (\$10.50 foreign). Use coupon today!

# TIME & MONEY

Mail coupon now!

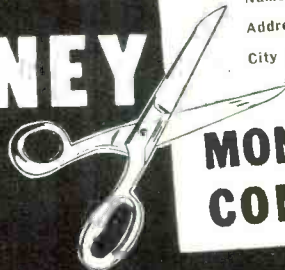





**ASK THE MAN WHO KNOWS THEM!**

Spintite wrench sets are the next best thing to an extra pair of hands. When you are turning out radios on the assembly line as I am, you sure appreciate tools that help speed production.

Spintite is the wrench that's built and works like a screwdriver. Available to fit square, hex or knurled nuts, it can be had with either fixed or chuck-type handle. Ranging in size from 3/16" to 5/8", there are Spintites to meet every requirement of radio assembly and repair. If you ask me, Spintites are the answer.



No. T-51 chuck-type Spintite with seven Spintites, three Screw-drivers and Reamawl, in leatherette roll.



**STEVENS • WALDEN**  
INCORPORATED  
Worcester • Massachusetts

tions toward lively programming will be news events, broadcast on-the-spot. Widespread development of "sand-lot" radio talent is also anticipated.

**TELERAN** is the brain-child of Loren F. Jones, a pilot and one-time ham radio operator, who has been working on it since 1941, but didn't get very far during the war years, when RCA was busy with more urgent problems. Resuming his development about a year ago, Jones expects to see it at production stage within five years. Ground-and-air demonstrations should be ready within a little more than a year. Teleran is a coined word—TELEvision plus Radar Air Navigation—and grew out of RCA experience with airborne radar dating from 1935 and with airborne television, dating from 1936.

**"IN ITS SIMPLEST FORM,"** to quote Mr. Jones, "Teleran employs a ground search radar which surveys the air space and displays the information obtained on a cathode ray tube. This radar presentation is viewed by a television camera, a map of the area is superimposed either optically or electrically, and the combination picture is broadcast by a television transmitter. The pilot sees his plane as a spot of light moving across the map; other planes are similar spots, or pips, moving along their actual routes." Greatest Teleran achievement is taking actual radar and other heavy equipment out of the cockpit, where weight is a tremendous factor.

Teleran will, of course, be less expensive than radar equipment—Jones estimates that with a mass market a unit can be bought for as little as \$500. Although this price is still high for the average amateur pilot, Jones feels that the system will pay off in safety and efficiency when there are enough planes in the air to make installation worthwhile. . . . Regardless of the future, FCC is regarding it as a potential factor in the airways of the future, and if it develops, even to a small degree, it should open new vistas—not to mention a number of new jobs—for those interested in electronics.

**IF YOU OWN** a taxi-cab radio unit, you can tune in on other two-way taxi radio hook-ups clear across the country, according to frequency assignments recently announced by FCC. Same thing applies to other radio systems now being assigned to urban use. Reason for the assignments is that FCC has been flooded with demands for experimental operations in the field of general mobile service in big cities. To meet the demands, the Commission devised a temporary frequency assignment plan to be followed so that everybody has an opportunity to see if the radio is fitted to his needs. Assignable channels for land stations and mobile stations are six—152.03 mc., 152.15 mc., 152.27 mc., 152.39 mc., 152.51 mc., and 152.63 mc. The same number of channels have been assigned for mobile stations only

—157.29 mc., 157.41 mc., 157.53 mc., 157.65 mc., 157.77 mc., and 157.89 mc. Channels 152.27 mc. and 157.53 mc. may be assigned to taxicab systems, while department stores, delivery services, ambulance services and the like will get 152.15 mc. and 157.41 mc. Other channels will go chiefly to experimenters in the field and to existing general communications common carriers. "In no event," FCC has ruled, "will any land station be permitted to use a mobile frequency" without a mobile hook-up.

**CLOSELY LINKED** with these channel allocations was FCC's recent announcement following recommendations from all parties concerned that readjustments were being made in allotments in the 152-162 mc. band. Chief reason was given as "the desirability of having a standard international maritime band in the v.h.f. region—a need recognized at the meeting on radio aids to marine navigation in London. At this meeting it was revealed that the United Kingdom had already allocated four pairs of single channels each 100 kc. wide between 156 and 162 Mc. U.S. representatives faced with "insurmountable" obstacles in obtaining agreement on frequencies elsewhere in the v.h.f. spectrum, decided to go along with the British allocations. . . .

**FCC reports big activities** in the maritime radio field, and a bright future. Safety and distress services will be standardized as the result of the international agreements, and communications are developing rapidly between ships of all nations and land bases associated with shore-based radar transmitters and harbor control facilities. Fog as a major menace in crowded sea lanes will, it is implied, soon become a thing of the past. Another aspect of marine radio with a brightening future is the use of v.h.f. radio-telephone from ship to shore near large ports. Radio will also figure more markedly as an intercommunication device in inland waters, especially among all types of water craft on rivers, lakes and oceans connecting the United States and Canada and the United States and Mexico.

**TWO INTERESTING** developments in the experimental field showed up a few weeks ago on the FCC dockets. One was the granting of a permit for an experimental class two station near Cleveland, Ohio, to be used in connection with development and testing of facsimile equipment. The permit went to Acme Newspictures, Inc., which is to say to the United Press, Scripps-Howard newspapers and other affiliates. It includes permission to experiment with transmitting pictures over long distances—to Acme posts in Europe and South America. Frequencies: 3492.5, 4797.5, 6425, 9135, 12862.5, 17310, and 23100 kc. on a temporary basis; power 1000 watts; A4 emission.

(Continued on page 166)



Grasp the **NEW OPPORTUNITIES** in

# RADIO ELECTRONICS AND TELEVISION NOW!

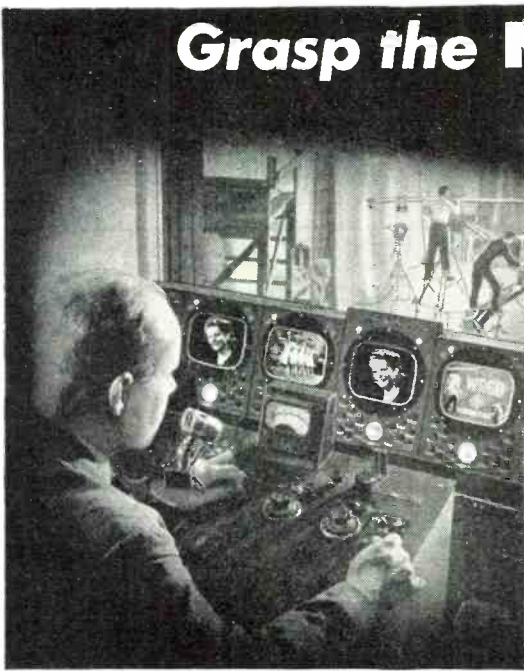

**Modern Radio – FM Broadcast and Reception – Television – Industrial Electronics; Power, Control, Communications – new equipment and methods demand new technical ability and experience. Keep up to date with the latest.**

**MODERN RADIO EQUIPMENT FOR YOU TO USE AND KEEP**

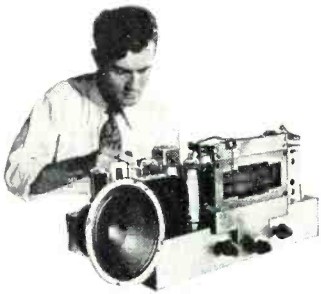

The very essence of National Shop Method Home Training is **EXPERIENCE**. You get actual experience by working with modern Radio and Electronic equipment—building many types of circuits. You may build a fine, long distance **MODERN SUPERHETERODYNE**, signal generator, miniature radio transmitter, audio oscillator, etc.—many other standard actual operating pieces of equipment—conduct cathode ray and other experiments. This practical work advances with your training—**YOU LEARN BY DOING!**

## Shop Method Home Training

By a Real Established Resident School with its own FM Studios, Shops and Laboratories.

### TRAIN WITH ADVANCED TECHNIQUE

The good jobs in Radio Electronics now go to the men who are equipped to handle them. It takes training and experience. National Schools, one of the oldest and largest trade schools in the country, makes it possible for you to get this training right in your own home **IN YOUR SPARE TIME**.

National maintains modern resident training Studios, Shops and Laboratories where instructors and engineers are working constantly to improve training methods. **SHOP METHOD HOME TRAINING** is a logical extension of this practical system.

A **FREE** lesson that shows you how practical and systematic this new training method is will be sent you without obligation. You may keep and use this lesson to prove to yourself just how practical National Training really is.

Get one of the many **NEW JOBS** that demand new techniques and methods in Modern Radio. Get your share of the **NEW BUSINESS** that servicing the new sets and equipment demands. Experts agree that Radio, Television and Electronics present opportunities

much greater than ever before!

Radio is expanding with far-reaching improvements in reception. No one knows yet how great the Television market will be. Electronics will touch almost every walk of life—in industry and in the home.

**TURN YOUR INTEREST IN RADIO INTO A CAREER THAT WILL ASSURE YOU SUCCESS AND SECURITY.**

### FIND OUT WHAT NATIONAL TRAINING CAN DO FOR YOU

Where do you stand today in modern industrial progress? What does the future hold for you? You owe it to yourself to investigate this opportunity. With National Training **YOU GET AHEAD FAST**—you may step into a good position or start a business of your own, with little capital, even before you complete your National Course.

Fit yourself for a career of independence, good earnings, success and security in one of the fastest growing fields in industry. For full information, just send your name and address on the coupon and mail it **TODAY**.

# FREE LESSON

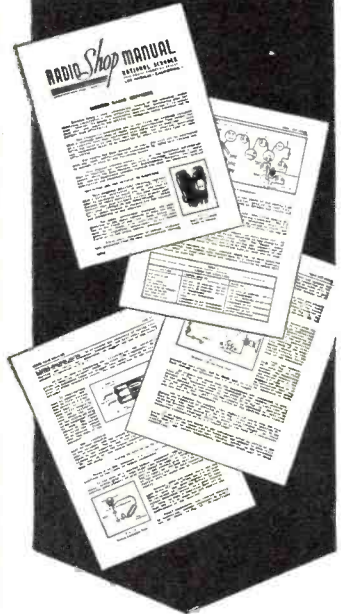

## Get This Book FREE

This big book presents the facts about the field of Electronics and your opportunities in it together with full information about the advanced National Training. Read it and make up your own mind that National Training will equip you for a great future. No salesman will call on you from National. The book is **FREE** with your sample lesson. Clip and mail the coupon **TODAY!**



## NATIONAL SCHOOLS

LOS ANGELES 37, CALIFORNIA EST. 1905



### MAIL OPPORTUNITY COUPON FOR QUICK ACTION

National Schools, Dept. 1-RN

4000 South Figueroa Street, Los Angeles 37, California

(Mail in envelope or paste on penny post card)

Mail me **FREE** the two books mentioned in your ad including a sample lesson of your course. I understand no salesman will call on me.

NAME ..... AGE .....

ADDRESS .....

CITY ..... STATE .....

Include your zone number

Check here if veteran of World War II

## See What National Training Has Done For These Men

National Shop Method Home Training wins good jobs, independence and security. Take the word of National men who have established records in their favorite Radio, Television, or other branches of Electronics.



From O. K. Ivey, Washington, D. C., comes this endorsement: "I believe National offers the best course to be had ... Keep up the good work."

Here's a statement from R. R. Wright, Blackfoot, Idaho: "Due to my training at National I was selected to instruct in the laboratory work of Navy and Marines."



Clifford Hannah, Portage La Prairie, Manitoba, Canada, writes: "My training has brought results as I'm in line for

another raise thanks to National's encouragement and thorough training."

Joseph Michel, Jr., Granite City, Illinois, writes: "I am enthused with National training. I am now earning \$225

a month as a radio operator and technician and \$20 a week more in my shop at home."

Read what other enthusiastic students have written about National Training in the big 40 page book we will send you.

APPROVED FOR TRAINING UNDER GI BILL



# EXPERIMENTING WITH

# UHF?

## RELAYS

- A. DPDT 110a contacts, 115v/60 cps coil. ALLIED .....\$1.59
- B. SPST 5a. ac; 115v cont. 115v/60 cps.... 1.25
- C. SPDT contacts; coil rated 115v/60c .....\$4.39
- D. DPDT 115/60c. cont. rating 5a at 50v. W. E. Co. .... 1.49
- E. DPST Telephone type; 2p, 1 cl; 1 open; cont. rating 5a at 50v. coil rating 3.5 ma (at 12k ohms), 1000 vac..... 1.05
- F. DPDT Steatite insulated 10 amp silvered contacts, made by Leach..... 1.95
- G. SPDT Struthers-Dunn sensitive keying relay, 5 MA-DC Coil, 110v/60 cycles—2 Amp contacts ..... 1.49
- H. DPST 6 v., 60 cycle, steatite insulated relay, 10a contacts..... 1.49
- J. DPDT 6v., 60 cycle Dunco relay, 10a contacts ..... 1.69



## MICRO WAVE EQUIPMENT



MAGNETRONS! Westinghouse type 2432 (JAN) just released. This is the first large lot of MAGNETRONS to flow into the civilian market! The 2432 is designed for 10 cm. operation. Brand new, packed in individual protective cartons. The 2432 is listed at \$200.

- OUR PRICE ..... **\$25.50**
- 3J31's just received. One cm magnetron. Listed at \$95.00. OUR PRICE..... **\$20**
- Duplexer using 1B24 (3 cm)..... 10.00
- KLYSTRON Oscillator Tubes 2K25/723-ab, designed for 3cm. operation. New. Packed individually. Listed at **\$7.75**
- \$38.00. OUR PRICE..... **\$2.95**
- 1B24 T-R tube..... 10.00
- 30 mc Oscillator-amplifier with 2 6AC7's. Uses 723a/b. Waveguide input, 1N21 xtal detector. With 6AC7's..... \$10
- With 6AC7's and 723a/b..... \$16.50
- Thermistor Brads. D-170396, for use with UHF and Micro-Wave Equipment. List @ \$3.00 in separate sealed containers. Each ..... **\$0.95**

## 3 CM WAVE GUIDE SECTIONS

- A. Straight Plated Directional Couplers with a 20 DB drop with:
  - A. Straight Wave Guide section 6" long..... @ \$3.95
  - B. 15° bend in wave guide 15"..... @ 5.90
  - C. 30° bend in wave guide 10" long..... @ 4.75
  - D. 90° bend in wave guide 15" long, also 90° bend in coupler ..... @ 6.50

## OTHER SECTIONS

- E. 2 1/2 ft. section 3-cm wave guide (choke to cover)..... \$5.95
- F. 2 1/2 foot silver plated with 90° bend (2" radius)..... @ 5.50
- G. 150° bend, with 90° twist 3/4" radium with pressurizing nipple and coax coupler..... @ 3.95

## Ohmite Wire-Wound Rheostats

- Model H 250 Ohms 25 Watt.....\$0.98
- Model H 125 Ohms 25 Watt..... .98
- Model J 1800 Ohms 50 Watt..... 1.25
- Model K 3000 Ohms 100 Watt..... 1.98
- Model L 250 Ohms 150 Watt..... 2.25
- Model L 100 Ohms 150 Watt..... 2.25
- Model N 22 Ohms 250 Watt..... 3.00
- Model P 1200 Ohms 225 Watt..... 2.75

Other ratings in stock in ohmite, Clarostate and Deiar. Inquire.

## D.C. HAND GENERATOR TYPE GN-45-B

Output: 6 volts at 3 amps. and 500 volts at .14 amps. Rated speed: 60 r.p.m. Used but in perfect condition.....\$5.75

- A. VHF Variable Condenser. 15-60 mmf. 1/2" air gap, 11 rotor plates. 6 stator, with feedback provision. Designed to operate in a tuned grid, tuned filament circuit. Listed at \$14. OUR price ..... **\$14**



- B. Split Stator. Cardwell PK-200-QD, 30-200 mmf per section. Special Hi-Volt. Listed at \$65..... **\$9.95**
- C. Johnson Type 500D35. Maximum cap. 500 mmf, min 35 mmf, .08" spacing, 3500v. Listed at \$11.75. Lowered to... **\$4.75**

## WESTON MICROAMMETER

WESTON 0-20 microammeter. 54mv scale 0-20. Model 301. Brand new!.....\$4.50

## RA-58-A HI-VOLTAGE POWER SUPPLY

Ideal for breakdown insulation testing, or as a source of power for a pulse transmitter. This unit supplies continuously variable voltages between 500 and 15,000 volts DC at 35 ma. A voltage Doubler circuit using two 705A rectifiers and two 1 mf condensers is employed. RMS ripple voltage at maximum power is 6%. THIS UNIT OPERATES FROM 115 v/60c. Variable voltage is obtained by means of a Variac in the primary circuit of the high voltage transformer. Size is 21" x 17 1/2" x 29" deep. Net weight 314 lbs. This unit sells for the low price of ..... **\$116**

## SPECIAL ITEMS

- Visors for 5 inch scopes.....\$0.75
- Broadcast band push-button tuning units inductive, capacitive types..... 2.98
- Switching choke: 2.5 Hy @ 375 ma; 10 hy @ 75 ma @..... 3.95
- Tube shields for 2AP1 (and others of the same size) ..... 1.25
- Transmitting key; 200 watt..... .79
- Matched pair precision resistors 6.33 megs. 3.00
- Antenna loading coil, heavy duty with six (6) variable tabs. 6 3/4" x 4 3/4" dia..... 2.95
- 52 ohm co-ax types, RG-8/U, RG-9/U, RG-38/U @ .05 per ft. minimum order. 1.50
- HANDSETS—WHILE THEY LAST! Famous TS 13 push-to-talk handset with 50-ohm mike and 200-ohm phone, 1 each PL-55.....\$5.95 and PL-68. Selling brand new for.....
- Hook-up wire, stranded, 100 ft.....\$0.95
- Mycalex strips 1/4" x 3/4" x 14 1/2". Each..... .10
- 12 for \$1.00. Minimum order..... .60

## UNITS AND ASSEMBLIES



NEW POWER SUPPLY for LM-18 frequency. Output: 290 v. @ 20 ma; 13 v. @ 600 ma. Input: 105-125 v. @ 60 cps; 260 ma; 27.6 W. type 84 rectifier tube; shock mounted. Complete with input and output cables, tube included ..... **\$14.75**

## PULSE AMPLIFIER

Signal Corps type BC409. Designed for 115 volts. AC 60 cycles. Component parts worth several times the price of this unit. Slightly used. Following are a few of the items that make up the unit. 1-304TL (Eimac). 3-2 mfd. 4,000 V. V-X-GE Pyranol condensers. 1-3200 volt 150 MA power transformer. 1-Variac 5 amps. General Radio type CU 200. 1-5 volt 26 amp. filament transformer (for 304 TL). 1-2.5 volt 10 Amp. filament transformer (5000 volt insulation). 1-1 mfd. 1000 volt GE Pyranol. 1-2 mfd. 1000 volt GE Pyranol ..... **\$59.50**

## NEW USN NAVY MODEL RAK-7 SHIP RECEIVER



15 kc to 600 kc. 6-tube receiver with: AVC-Hand pass filter-Audio filter—Noise limiter—Precision tuning with a Vernier dial—Voltage regulated power supply, with three tubes, for 60 cycle, 115 volts. Can be battery operated. Complete with spare parts box weighing 73 lbs., spare tubes and inst. .... **\$69.95**

B-29 Computer Amplifier, containing 8-JAN6SN7 amplifier tubes, 1-6X5 GT, 8-relays, 5-neon glow lamps, completely wired amplifier circuit with many components. This fine amplifier was designed for use with remote-controlled guns. This buy sells for..... **\$14.75**

Low Voltage Power Supply for AN/APS-10, using 3-6X5 GT's, and 1-9006, complete with 6 chokes, 1 power transformer, and filter condensers..... **\$6.50**

All merchandise guaranteed. Mail orders promptly filled. All prices F.O.B. New York City. Send Money Order or Check. Shipping charges sent C.O.D.

## COMMUNICATIONS EQUIPMENT CO.

131-A Liberty St. New York City 7, N. Y. Telephone WH 4-7658

## TUBE BUYS!

Tube Type	Approx. List	Your Cost
3BP1	\$15.00	\$ 3.95
3FP7	27.00	3.35
5BP1	20.00	4.95
5BP4	27.00	5.95
5CP1	45.00	4.95
5CP7	48.00	6.00
5FP4	38.00	4.95
5FP7	32.00	4.25
51P2	48.00	13.50
837	2.80	1.50
872A	7.50	3.50
705A	22.50	6.75
241B-WE	85.00	50.00
861	155.00	95.00
2C40	.....	5.95
2C43	.....	8.95
Sockets for 5CP1; 3BP1, and similar types of tubes ..... \$ .95		

## OIL-FILLED CONDENSERS

500 mf 200 vdc.....	\$1.95
2000 mf 50 vdc.....	2.00
4000 mf 50 vdc.....	2.25
1 mf 300 vdc.....	.30
2 mf 300 vdc.....	.30
4 mf 300 vdc.....	.35
4 mf 400 vdc.....	.55
1 mf 600 vdc.....	.35
2 mf 600 vdc.....	.40
3 mfd 600 vdc pyr.....	.65
4 mf 600 vdc pyr.....	.70
6 mf 600 vdc pyr.....	.95
10 mf 600 vdc pyr.....	1.49
15 mf 300 vdc.....	1.95
1 mf 1000 vdc.....	.90
2 mf 1000 vdc.....	1.10
1 mf 1500 vdc.....	1.20
4 mf 1500 vdc.....	.30
2 mf 660 ac/1000 vdc.....	.95
1 mf 2000 vdc.....	1.00
2 mf 4000 vdc.....	3.95
1-1 mf 7000 vdc.....	4.95
.75 mf 20,000 vdc.....	22.00

- G.E. Pyranol 23F47 2mf 4000v. Last \$30. **\$5.95**
- G.E. Pyranol 23F49 1mf-5000v. List \$27. 4.75
- C-D TC-50010 1mf 5000v (list \$30)..... 4.50
- G.E. 14F191 .1mf 10000v (list \$37). 6.75
- G.E. Pyranol .06 mf 15,000 vdc (list \$75)..... 5.95

## SANGAMO MICA CONDENSERS

- F3L .0003 mfd 8000v list \$29..... \$3.75
- F3L .0015 mfd 8000v list \$31..... 4.00
- Solar type SX .0015 mf 3000v—list \$9.95 ..... 7.75
- Sangamo G-4 .004 mf 20kv (list \$110)..... \$25.50
- Sangamo G-3 .008 mf 10kv (list \$87.50)..... 19.50

## TRANSFORMERS

AMERICAN PLATE TRANSFORMER! 115 v-60 cycle primary, 6200 volt-ct-700 mil secondary. Size 11" x 14" x 6 1/2". 700 M.A. CHOKE. Can be used with American Transformers..... **\$7.95**

1/2 WAVE RECTIFICATION—115v-60c/3200v at 150 mls. MADE BY KENYON..... **\$9.95**

Power supply transformer. Pri. 115/60 cps Sec. 1.750v-113a; Sec. 2.6.3v-5a; Sec. 3.5v-3a. 2500Vt specially priced at \$5.95.

Flament xfmr. 115vac/ 6.3v-6ac.t. 6.3v-5a.c.t. (dual windings) KS-8767.....\$2.75

## AUDIO TRANSFORMERS

Line to Voice coil transformer. Pri. 600 ohms, Sec. 6 ohms. 1200 Test volt.....\$1.75

Audio output transformer Split pri. 1500 ohms each side. Secondary impedance 85 ohms center-tapped—6:1 ratio. 100 Watts output ..... 7.50

Modulation xfmr: typical for 211's CLA/50W ..... 1.35

Modulation xfmr: 807 to pr 807's in parallel 1.00

Modulation xfmr: pr. 811's to 813..... 5.00

## CHOKES

- 12 hr-12 hy @ 150 ma., 15 amp rating, each. Price.....\$4.25
- 15 hy @ 165 ma 200 ohms DCR, made by Jefferson. Price..... 2.00
- 59 hy @ 100 ma 850 ohms DCR, made by Jefferson. Price..... 2.00
- 2.6 hy @ 800 ma stud and terminal at bottom. Price..... 5.00

## SELSYN MOTORS

Ideal for remote control, or for antenna rotation. Size 53. Cost per pair ..... **\$7.75**



## XTAL FILTER

I-F Crystal filter for BC-312, BC-342, Resonant at 470 kc Crystal included. .... **\$6.95**



# how **AMPHENOL** eases television's growing pains

A glance at the new Duodecal socket shown below will demonstrate the complete fulfillment of television's demand for a socket of full flexibility and highest quality for the new series Duodecal base television viewing tubes.

This is typical of the pioneering which has established Amphenol leadership in the design and manufacture of TV and FM components.

The activity of Amphenol engineers in the higher frequencies enables them to sense in advance the needs in these fields. The new Duodecal socket is but one of many such Amphenol firsts which include efficient Hi-Q tube sockets, octal angle sockets for cathode-ray and other tubes, Twin Lead parallel transmission line, FM and television receiving antennas, solid dielectric coaxial cables, and special-use cables for television color cameras and for facsimile.

Write for Data Sheets on these new products.

**AMERICAN PHENOLIC CORPORATION**  
CHICAGO 50, ILLINOIS

## FEATURES OF THE DUODECAL SOCKET

- Six locations for bringing leads out radially in one bundle assure a neat wiring harness, and minimum space requirement.
- Rear socket cap totally encloses connections, eliminating breakage at solder terminals due to flexing. Electrical shock hazard is minimized.
- An extra opening is provided for bringing high-voltage grid lead out separately when this is desirable.
- Latest wrap-around type cadmium-plated phosphor-bronze contacts provide four lines of contact on each tube pin.
- Cap and body of socket are molded black electrical bakelite.
- Spring-ring assembly eliminates screws and drive pins.

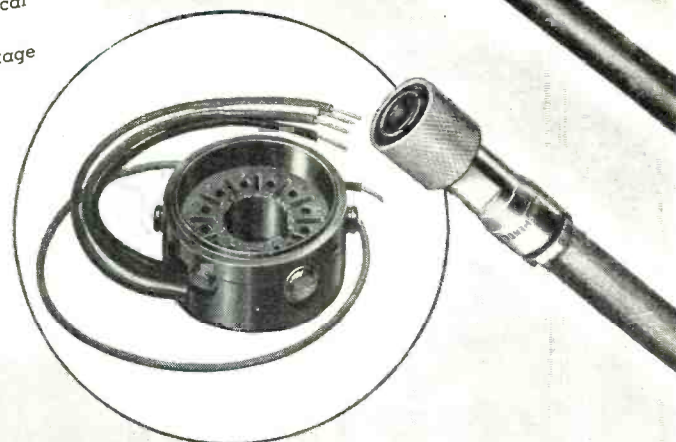

COAXIAL CABLES AND CONNECTORS • INDUSTRIAL CONNECTORS, FITTINGS AND CONDUIT • ANTENNAS • RADIO COMPONENTS • PLASTICS FOR ELECTRONICS





# ESSE Specials!

**RBL-2  
RADIO RECEIVER**  
Navy Type GNA-46161



Built by National Company, these are brand-new and come complete with tubes and ready to operate except for connection to phones speaker. It is a 7-tube tuned radio frequency receiver covering 15 to 600 KC in six bands. The circuit employs both low and high pass filters and adjustable audio limiter.  
Tubes used: 3-6SK7, 1-6SG7, 1-6H6, 1-6K6GT/C and 1-5U4G.  
Operates from 110 V. 50/60 cycle AC source. Dimensions overall, 12 13/32" x 17 11/32" x 17 1/4". Weight, 80 lbs.

Price - New ..... **\$63<sup>50</sup>** ea.

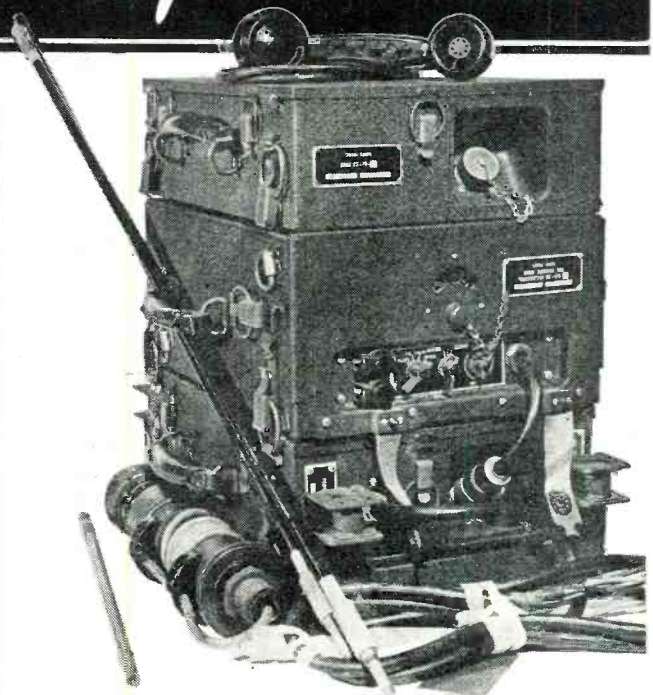

**RADIO SET SCR-510 Brand-New**

Radio set SCR-510 contains a portable low power, frequency modulated Radio Receiver and Transmitter BC-620 for voice communication over a range of approximately 5 miles with frequency range of 20 to 27.9 mc. on any of 2 preset channels. It obtains its power from dry batteries or may be used in vehicular installations obtaining power from vehicular battery. Dry battery power requirements: Receiver "A" 1.5 V., 7 amp. "B" 90 V. at 25 ma.; Transmitter "A" 7.5 V. at 3 amp. "B" 150 V. at 45 Ma. Vehicular Power Requirements: 6.2 V. at 2.8 amp. rec. 3.5 amp. transmitting; 12.4 V. at 2.1 amp. rec. 2.9 amp. transmitting. Set including 2 crystals, microphone headset, battery case CS-79, vehicular power unit PE-97 and both vehicular antenna and portable antenna. Weight, BC-620, approximately 27 lbs.

Price - New, complete as described ..... **\$75<sup>00</sup>** ea.



**BC-1206-C**

Built by Satchell Carlson, this is a light-weight, 5-tube superheterodyne receiver covering 200-400 KC radio beacon frequencies. Complete with the following tubes: 2-14HT, 1-14J7, 1-14R7, and 1-28D7. Output impedance 300 ohm with provision for 4000 ohm with slight circuit change. Complete with headset and extension for operation from any 24-28 V. DC source. Current consumption, .75 amp. May be used in light planes by connection of dry batteries to give necessary voltage. No high voltage power supply used which gives the set maximum efficiency.  
Dimensions: 7 1/2" x 4" x 4 1/4". Weight, 4 lbs.

Price - New, complete .. **\$19<sup>75</sup>** ea.

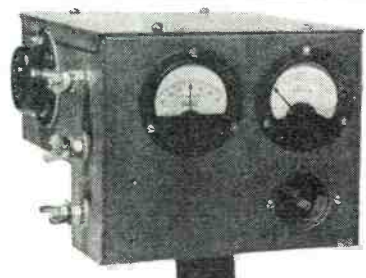

**CONTROL BOX Brand-New**

Use for parts, etc. Contains: 30-0-30 2 1/2" DC ammeter, 0-300 2 1/2" AC voltmeter, 60 amp. push-button switch, .01 and .3 mfd. 600 V. cond., 10 mfd. 50 V. cond., 2 ohm rheostat, 15 amp. filter choke, binding post, etc.

Price ..... **\$4<sup>85</sup>** ea.



**LOCALIZER CONTROL BOX**

Contains SPST toggle switch, 12,500 ohm volume control, phone jack, SPST six position switch, mounted on aluminum box 3 1/16" x 2 1/16" x 1 7/8".

Price .... **35c** ea.



**26' CO-AXIAL CABLE**

Complete with amphenol connectors as shown. Brand new.

Price ... **\$1<sup>25</sup>** ea.

**TERMS:**  
**CASH with ORDER**  
or **25%**  
**BALANCE C.O.D.**  
All Items  
Shipped Collect

# ESSE Radio Company

130 W. New York St. - Indianapolis 4, Ind.



# RADIO SERVICE TECHNICIANS

use the **BLILEY CCO..**

for

instant channel selection

and frequency accuracy



Ask your Bliley  
Distributor for  
Bulletin 32

SUPPLIED COMPLETE WITH 7 CRYSTALS,  
TUBES AND CONCENTRIC OUTPUT CABLE.

The Bliley CCO (crystal controlled oscillator) is the only test instrument available to radio service technicians that features —

## DIRECT CRYSTAL CONTROL

- with instant channel selection of the five most commonly used intermediate frequencies — 175 kc, 262 kc, 370 kc, 455 kc, and 465 kc.
- at 200 kc for r-f alignment.
- at 1000 kc for short wave alignment.

**Bliley**  
CRYSTAL CONTROLLED OSCILLATOR

Finger tip adjustment is provided by a three position modulation selector and a five step attenuator, with vernier output from 0 to 15 volts. An external socket accommodates extra crystals that may be needed for special requirements.

There is nothing complicated about the Bliley CCO. Simply connect it to the receiver to be tested and select the frequency desired. The crystals are instantly on frequency as soon as the oscillator is energized. It will save you hours of time, eliminate guess work and increase your prestige as a radio service technician.

The CCO is a "technicality" product of the same engineering skill and craftsmanship that have kept Bliley Crystals foremost in dependability in the frequency control field for over 15 years.



# HQ · 129 · X

*backed by 36 years of know-how*

Many thousands of amateurs are using the new HQ-129-X communications receiver. Rarely has a new product been so widely approved in so short a time. The reason is simple—36 years experience and a record of high accomplishment build confidence. The HQ-129-X is an outstanding value from the standpoint of performance and cost.



## HAMMARLUND

THE HAMMARLUND MFG. CO., INC., 460 W. 34TH ST., NEW YORK 1, N. Y.  
MANUFACTURERS OF PRECISION COMMUNICATIONS EQUIPMENT

*see*  
the HQ-129-X  
at your dealer's.



# RADIO CONTROLLED FLIGHT\*

The PQ-14, radio controlled AAF plane which provides realistic target for anti-aircraft gunners.

EDITOR'S NOTE: Since the recent appearance in RADIO NEWS of several articles on the atom bomb test and drone planes, we have received many letters requesting more detailed information on the electronic equipment used to control the drone planes.

In view of this fact, RADIO NEWS brings to its readers in this article much of this information. The material contained herein is as detailed as possible under present security regulations.

**A**N AMERICAN Army Air Force, technically superior in all phases of air defense or warfare, is a tired world's surest guarantee against the terror of war. Rockets and missiles, controlled by radio, traveling at supersonic speeds and equipped with atomic warheads, shrivel the imagination.

But in August the Army Air Forces revealed that two B-17 Flying Fortresses had flown the Pacific without pilots aboard. Though the news received but slight attention, it pointed the road to future military and civilian aerial activity.

The flight from Hawaii, known as *Operation Remote*, took to the air at Hile and flew 2600 rugged overwater miles before coming down at Muroc Army Air Field, California. The drones were accompanied by mother planes which directed all their flight operations by radio. Throughout the 14 hours and 55 minutes of the record-breaking journey, the mother planes maintained contact with their crewless charges at distances varying from 200 feet to three miles.

Before landing at Muroc, one of the

\* This article was prepared by the Information and Public Relations Division, Headquarters Army Air Forces, New York, New York.

***For peace or war, the radio control of airplanes and rockets marks a new era in aviation history.***

drones dropped a practice smoke bomb off Santa Rosa Island. This involved opening the bomb bays, releasing the bomb and closing the bomb bays, all by remote control.

The two drones which spanned the Pacific were veterans of the Bikini atom bomb blast. Together with a number of other AAF drones at Bikini, they gathered invaluable data which will enormously increase scientific understanding of atomic phenomena.

The current drone research program

is being pushed with high intensity by Headquarters Army Air Forces through its technical branch, the Air Materiel Command, located at Wright Field, Dayton, Ohio. However, the present activity is just one facet of the total investigation into the application of radio control to flight. It is an integral part of the research program which began with the development of target planes and is currently concerned with guided missiles and completely automatic flight.

The latest model in the target plane

Radio jeeps, near runway, control take-off and landing of the drone planes. One works the elevators and throttles of the drone while other controls direction.





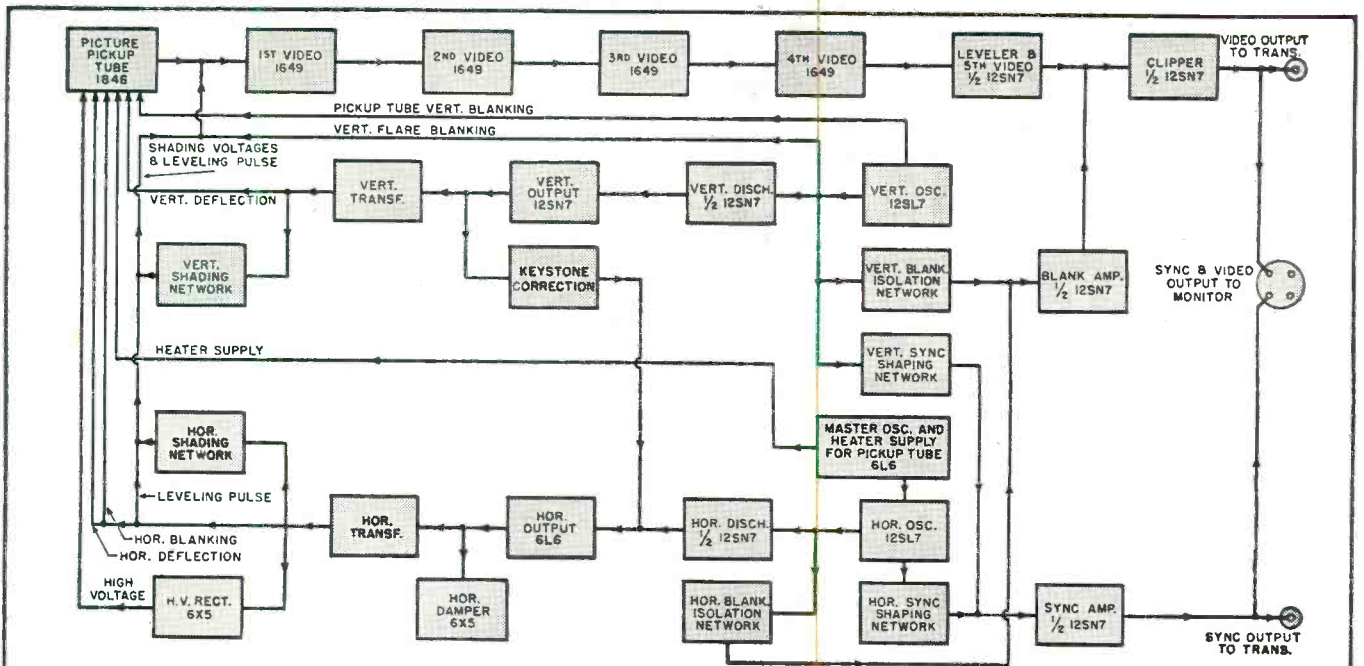

Functional block diagram of conversion unit PH-522/AXT-2 used in drone plane.

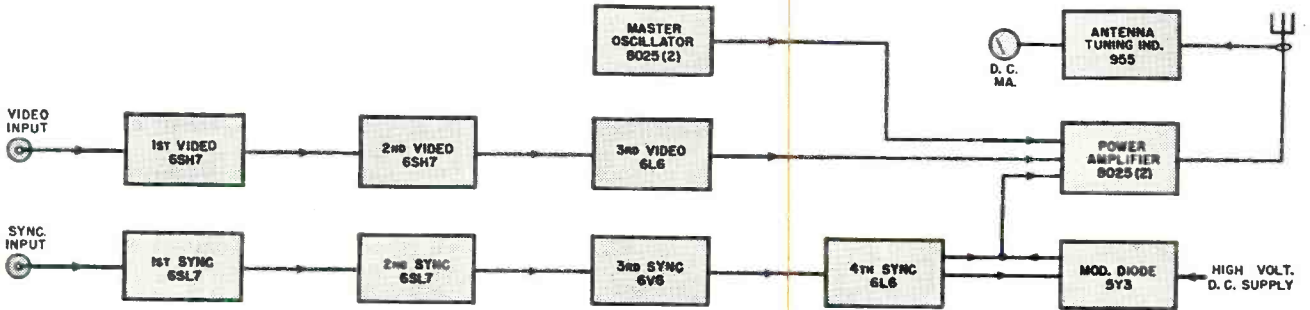

Block diagram illustrates stage-by-stage operation of T-61/AXT-2 transmitter installed in drone airplane.

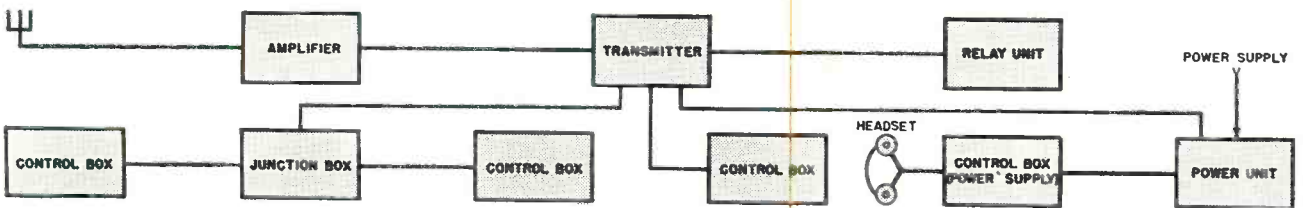

AN/ARW-18 radio control transmitter installed in the "mother" plane.

Radio receiver and selector, AN/ARW-1, installed in the drone aircraft.

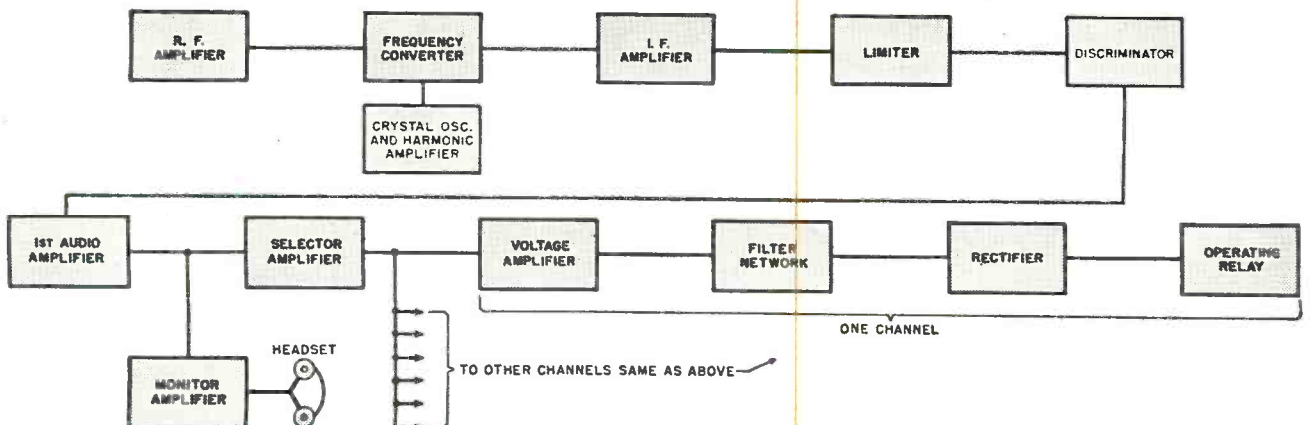



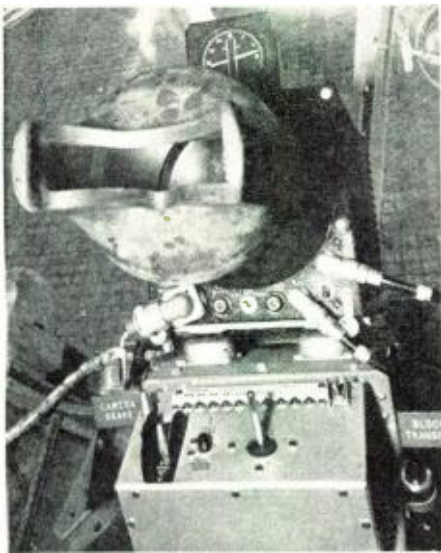

The control box which relays "commands" from the "mother" plane to the drone. Above the control box is shown the television scope which allows the pilot to view the instrument panel in the drone being controlled or alternately, permits him to see the area directly in front of the drone plane. This equipment should find wide application in the testing of experimental models of aircraft, thus eliminating the necessity for endangering a test pilot's life.

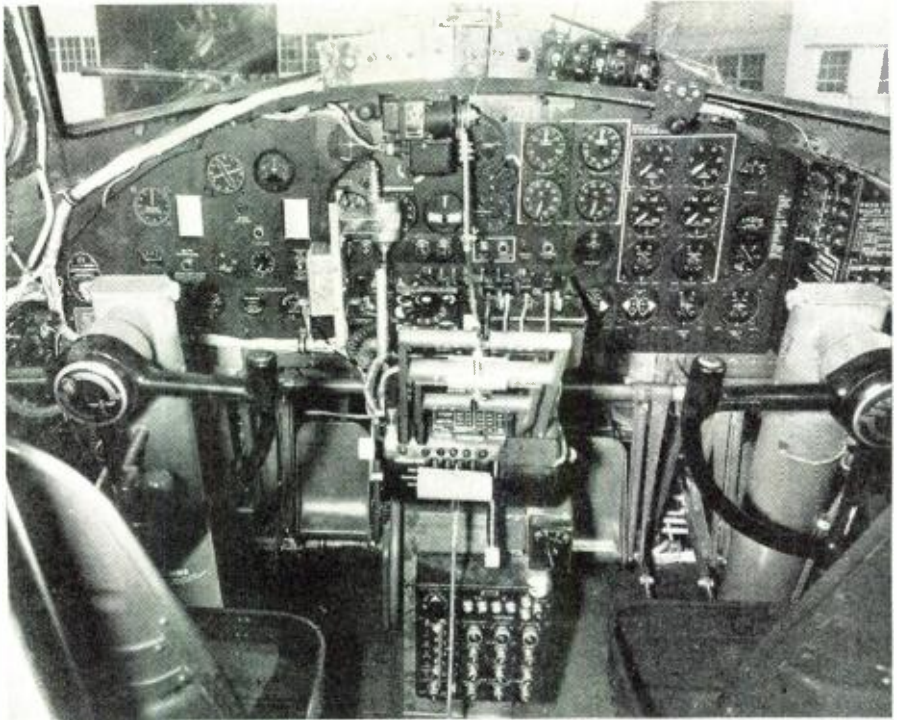

Full view of the cockpit of the modified Boeing B-17 radio controlled drone aircraft designed for use on the Crossroads Project atomic bomb test. Pilots are excess baggage in B-17 drone. Controls are activated by radio signals emanating from the "mother" plane or the ground control station.

category is the PQ-14. Controlled by radio and maneuvering much as an enemy combat plane would under field conditions, the PQ-14 is a lifelike target which eager marksmen actually can shoot down.

In operation, the PQ-14 is trailed at a safe distance by a mother plane, much as in the *Operation Remote* set-up. A pilot sitting in the co-pilot's seat of the mother ship holds a small control box on his lap. Flipping a lever on the upper left hand corner of the box gives the pilot the function he wants. Small lights indicate the number of functions the drone will perform and give the pilot a check on the operation desired.

On the lower right hand side of the control box a small metal "stick," similar to an airplane control stick, is moved to give the horizontal and vertical movements demanded of the

PQ-14. Another switch is available on the control box for auxiliary operations.

A frequency-modulated, ten-channel radio receiver relays the "commands" of the mother plane to a gyro-stabilized, remote flight control unit which actuates hydraulic servo motors. This unit corrects the three functions of roll, pitch and yaw, and, in addition, applies the brakes. Through its use, the PQ-14 is enabled to perform maneuvers including 70-degree banks and dives.

Such auxiliary operations as throttle control, retracting and extending of the landing gear, and raising and lowering of the flaps, are accomplished by radio activation of small electric motors which are installed as standard equipment in the target plane. Coordination between the control plane and the target plane is instantaneous.

Drones were in operational use during the recent war. War weary B-17s, which had flown full quotas of missions against German installations, were used as guided missiles in a project known as *Operation Castor*. The planes were not outfitted to take off by remote control. A minimum crew took them up and, after the mother plane assumed radio control, parachuted to earth.

The first Flying Fortress flown in this operation was directed at the submarine pens at Helgoland, Germany, on September 11, 1944. Unfortunately, it was shot down by anti-aircraft fire 1000 feet short of its goal. Another, guided to these same high-priority objectives in October, destroyed 2½ acres of buildings in the target area.

In current usage, such as the trans-Pacific flight, the drone is equipped  
(Continued on page 137)

Functional block diagram of the R-68/AXR-1 television receiver used in "mother" plane.

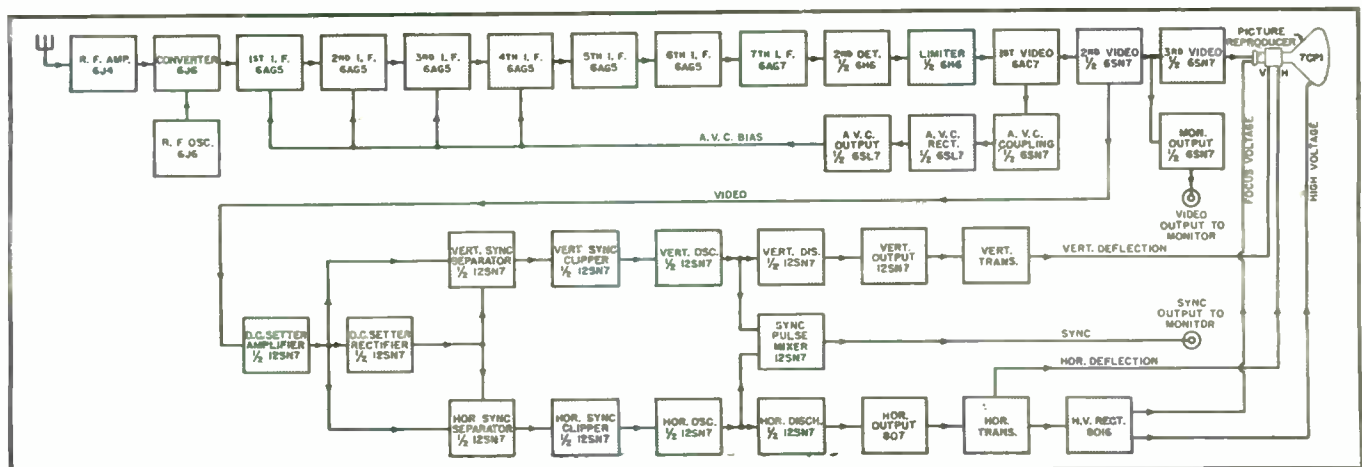





This simple oscillator features an 832 TNT oscillator with butterfly condenser used in plate circuit, achieving stability equal to crystal control.

# A Stabilized Modulated OSCILLATOR

By ALBERT E. HAYES, Jr., WHIN/3  
Consulting Engineer

**Presenting a novel method of eliminating the frequency modulation usually attendant in modulated oscillators.**

OUR old friend, the modulated oscillator, so popular during the early days of radio telephone transmission, has fallen into disrepute of late because of some of its inherent "bad habits." These "bad habits," or shortcomings, are, in the main, the introduction of spurious and undesired frequency modulation, and the fact that a modulated oscillator can not be modulated 100% without distortion due to the extreme falling off in amplitude on the negative modulation peaks where the anode voltage would approach zero for 100% modulation.

The second-mentioned shortcoming may be avoided by limiting the degree of modulation to 50% or less, as is done in conventional signal generators used by the radio serviceman, and the

first-named shortcoming, the attendant and undesired frequency-modulation, is lessened, but not eliminated by this expedient. The elimination of this spurious frequency modulation has been the subject of intensive study by the writer, and a circuit has been developed which enables a conventional radio frequency oscillator to be modulated upwards of 80% in amplitude without any trace of spurious frequency modulation.

The section enclosed within the dotted rectangle "A" in Fig. 1, illustrates a conventional triode tube  $V_1$  connected in a Hartley circuit as is done in many of the signal generators used by the radio serviceman. It is true that other arrangements are often used, but it will become apparent that the Hartley

circuit has been chosen for reasons of illustration only, and that the method of stabilization to be described may be applied with equal facility to other oscillator circuits without introducing new factors or considerations.

The parallel resonant circuit  $L_1C_1$ , connected in the anode-grid circuit of the triode, is normally considered to be the frequency determining element in such an arrangement. It is known, however, that the condenser  $C_1$  is shunted by several "invisible" capacities, such as, for example, the distributed capacity of the circuit wiring, the grid-plate capacity of the vacuum tube, and the reactance presented to the resonant circuit by the space current within the tube itself. This space reactance varies with the amplitude of the applied plate voltage, and it is this reactance which causes frequency modulation of a self-controlled oscillator when an attempt is made to produce an amplitude modulated output signal.

This space reactance causes a change in the effective resonant frequency of the circuit by an amount which is proportional to the percentage of its magnitude compared with the magnitude of the capacity of the condenser  $C_1$ . It can be seen, therefore, that the effect of the space reactance may be minimized by the use of a large condenser  $C_1$  so that the space reactance is but a small percentage thereof, and therefore causes a small net change in the resonant frequency of the circuit. This expedient, the use of a "high C" tank circuit, is well-known to all engineers skilled in the design of self-controlled oscillators, and has been used in most signal generators where stability of frequency is of paramount importance. The use of a "high C" tank circuit, however, lowers the over-all efficiency of the oscillator and increases the tank circuit losses. Further, this does not completely prevent frequency modulation, but merely minimizes it. The addition of the reactance tube circuit in Fig. 1 illustrates an arrangement for an amplitude modulated oscillator which completely eliminates frequency modulation and still permits complete flexibility of tuning of the oscillator proper.

A modulation transformer is connected in the plate supply circuit of the oscillator tube  $V_1$  in the conventional manner, and the plate of the modulator tube  $V_2$  is connected to the primary of the transformer. A reactance tube frequency modulator is connected between the plate of the oscillator tube and ground in the manner well known in the frequency modulation and automatic frequency control fields. The control grid of the reactance tube is connected to the output of the modulator tube  $V_2$  through a gain control potentiometer  $R_1$ , a reversing switch  $S_1$ , an audio interstage transformer  $T_1$ , and a condenser  $C_2$ .

In operation, the frequency modulation attendant on the amplitude modulation produced by the tube  $V_2$  is cancelled or "bucked" by an opposing fre-



# 1947 Specials from **KENYON**

**813 SOCKETS** Super special. **69c\***

**DYNAMOTOR PE-103-A**  
6 or 12 volts to 500 volts at 160 mils. Complete with relays, circuit breaker, overload controls, etc.  
**Close-out.....\$12.95**  
(Express chgs. collect)

**METERS**  
G.E. 300 MA-2 1/4" Meters.  
**Close-out.....\$2.95\***

**NEON BULBS**  
1/4 watt Neon Bulbs—SC Bayonet base, resistor less. Universally used for RF testers. Our price 19c each.  
**Box of 10.....only \$1.50**

## HAND MIKE

Famous T-17B of durable plastic construction, press-to-talk button, complete with cord.  
**Our price.....\$1.49\***

## TRANSFORMERS

5-volt, 4-amp Filament Transformer, 3000 volt ins. Special... **\$1.29**  
(Express chgs. collect)

2 1/2-volt-10 amp. Transformer, 10,000 volt ins.; 6.3 volts-4 amps CT, 8,000 volt ins.; 6.3 volts-1 amp CT, 8,000 volt ins. (Size 5 1/2" high x 4 1/2" wide x 3 1/2" deep.) Hermetically sealed.  
**Special.....\$3.95**  
(Express chgs. collect)

## KENYON MODULATION TRANSFORMERS

Type No.	Primary Ohms	Audio Level	Secondary Impedance	Price
T-455	10,000	60 watts	5, 7, 9 thous. Oh.	<b>\$8.10</b>
T-456	2,000	40 watts	5, 7, 9 thous. Oh.	<b>\$8.10</b>
T-458	10,000	80 watts	5, 7, 9 thous. Oh.	<b>\$8.10</b>
T-469	12,000	70 watts	4 1/2, 7, 10 thous. Oh.	<b>\$8.10</b>

(Express chgs. collect)

## ORDER NOW!

\* Add 10c and we will  
SHIP POSTPAID

**NO C.O.D. ORDERS**

**KENYON  
RADIO SUPPLY CO.**

2214 14th St. N. W.

Columbia 3161

WASHINGTON 9, D. C.

Distributors of Electronic Equipment

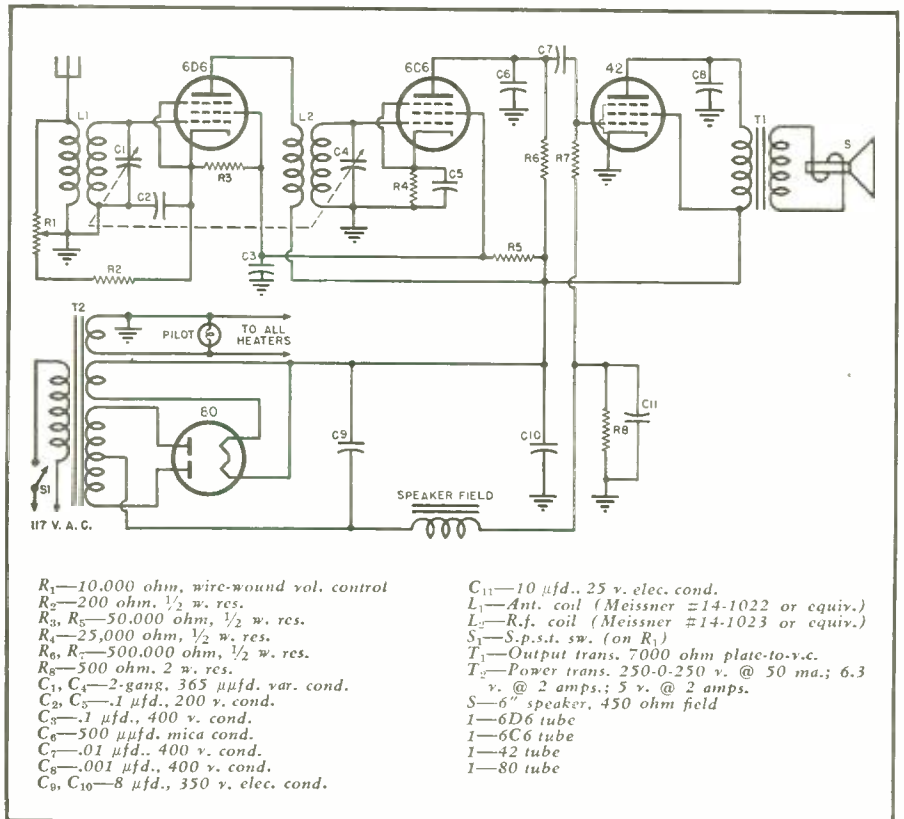

Fig. 1. Schematic diagram of the a.c. operated TRF receiver.

short as possible to keep the set from going into oscillation and from picking up hum from the a.c. leads. When wiring the filter condensers be sure to watch the polarity of these condensers; they will be marked on the case of the condenser or in most condensers the red lead will be positive and the black lead negative. If this condenser is salvaged from an old receiver be sure to notice which terminals are connected to the positive and negative leads in the old receiver.

Upon completing the wiring of the receiver, carefully check it with the diagram as this will save many hours of work later and will preclude burning out parts because of incorrect con-

nections. When the receiver is completely wired and checked, connect it to an a.c. line and a good outside antenna. One should be able to tune in several of the stronger stations. To get the receiver to operate properly one adjustment is necessary; tune in a station around 1400 kc. (the tuning condenser will be almost wide open); turn the volume down so the station can just be heard and adjust the two trimmer condensers on the variable condenser for maximum volume. If this receiver is connected to a good outside antenna reception of fairly distant stations may be expected occasionally.

—30—

Under chassis view of the 4-tube receiver showing simplicity of wiring.

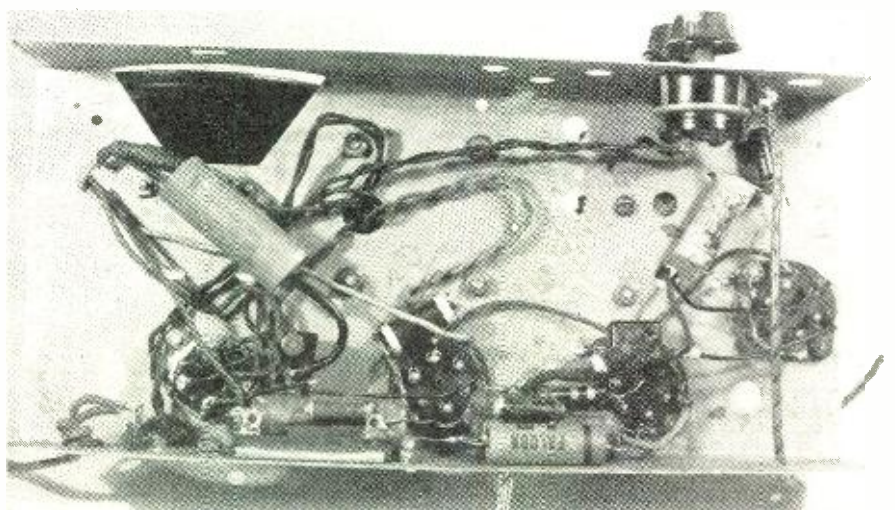



# OUR **GREATEST** ACHIEVEMENT

## IN 16 YEARS OF "SERVICE for the SERVICEMAN"

**Greatest...**  
IN  
**SERVICE**  
"clarified schematics"  
and a separate  
"HOW IT WORKS" book

Proud as we are of the time-saving qualities of every Rider Manual, we consider Volume XV our crowning achievement in this respect. Thousands of man hours have gone into its preparation in order to save thousands of servicemen millions of hours.

"Clarified schematics," and separate "How It Works" book are but two of the exclusive features that characterize the thoroughness of presentation on the products of over 120 receiver and associated equipment manufacturers; but two of the reasons why Rider Manual Volume XV is the biggest single volume yet issued.

Nowhere will you find anything to equal it in completeness and helpfulness. Nowhere will you find the wealth of original material which means a saving of your valuable time—cash in your pocket.

Volume XV is the latest contribution to our continuing promise that you will always find in Rider Manuals all the servicing information you need to operate with the utmost efficiency and profit.

John F. Rider



**Greatest...**  
IN  
**COVERAGE**  
OVER 120  
SET MANUFACTURERS

**Greatest...**  
IN  
**SIZE**  
2100 PAGES

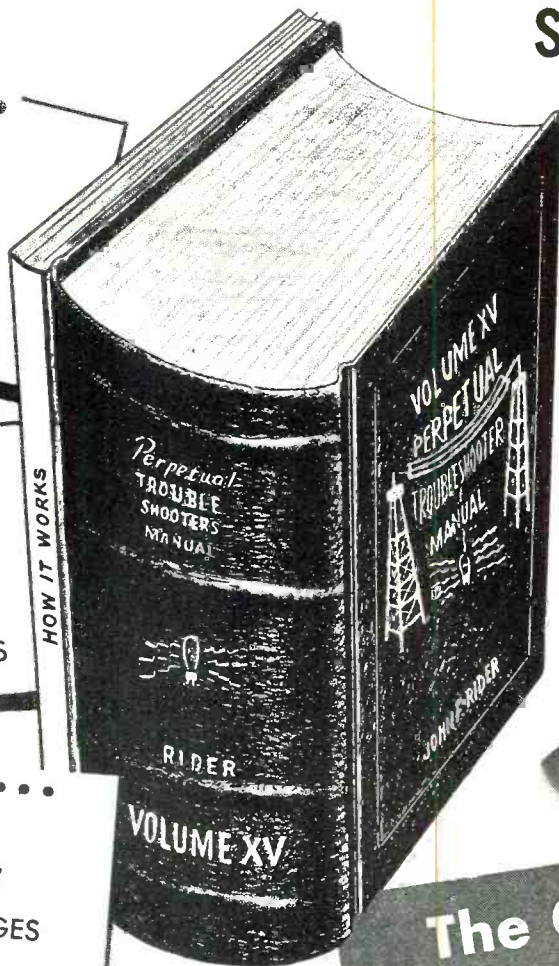

The **GREATEST**  
**RIDER MANUAL**  
**Volume XV**  
OUT IN JANUARY

**OTHER RIDER MANUALS**

Volumes XIV to VII, each volume.....	\$15.00
Volume VI.....	11.00
Abridged Manuals I to V (1 vol.).....	17.50
Record Changers and Recorders.....	9.00

**JOHN F. RIDER PUBLISHER, INC.**  
404 FOURTH AVENUE, NEW YORK 16, N. Y.  
Export Div.: Rocke-International Corp., 13 E. 40 St., N. Y. C. Cable: ARLAB

**RIDER RADIO BOOKS KEEP YOU IN TOUCH WITH SUCCESS**

Inside the Vacuum Tube Solid concept of theory and operation	\$4.50
Understanding Microwaves Provides foundation for understanding	6.00
Radar Entertaining, revealing, in lay language	1.00
The Cathode Ray Tube at Work Accepted authority on subject	4.00
Frequency Modulation Gives principles of FM radio	2.00
Servicing by Signal Tracing Basic Method of radio servicing	4.00

The Meter at Work An elementary text on meters	\$2.00
The Oscillator at Work How to use, test and repair	2.50
Vacuum Tube Voltmeters Both theory and practice	2.50
Automatic Frequency Control Systems —also automatic tuning systems	1.75
A-C Calculation Charts Two to five times as fast as slide rule	7.50

**Hour-A-Day-with-Rider Series—**  
On "Alternating Currents in Radio Receivers"  
On "Resonance & Alignment"  
On "Automatic Volume Control"  
On "D.C. Voltage Distribution" **\$1.25 each**



This new Rider Book, soon to be announced, will be of lasting usefulness to everyone interested in any phase of radio.

January, 1947



# HENRY RADIO

Most models listed below are in stock . . . ready for immediate delivery:

Hallicrafters S38 complete.	\$ 39.50
Hallicrafters S40 complete.	79.50
Hallicrafters S36A .....	307.50
Hallicrafters SX42 .....	250.00
Hallicrafters SP44 .....	99.75
Hammarlund HQ-129X & speaker.....	168.00
Hammarlund SP-400-X & speaker.....	342.00
National NC-2-40D .....	241.44
National HRO-5TA1 and HRO-5RA1.....	274.35
National NC-46 .....	97.50
National 1-10A with tubes and coils.....	67.50
RME-45 complete.....	198.70
RME-84 complete.....	98.70
RME DB-20 complete.....	68.20
Pierson KP-81 complete....	318.00
Panoramic panadapter complete.....	99.75
Temco 75GA transmitters...	495.00
Meck 60T transmitters.....	150.00
Gordon, Amphenol, Johnson rotary beams.	

The new Hallicrafters and Collins receivers, transmitters, VFO, etc. as fast as available.

All other receivers, transmitters, parts, etc. as available. Prices subject to change.

THE delivery situation is much improved. I can make immediate delivery of most receivers and other apparatus. Take advantage of the extra service and selection you get by dealing with me, based on my reputation as the world's largest distributor of short wave receivers. Send me your order now. Send five dollars and I will ship at once C.O.D. Or order on my 6% terms. I finance the terms myself to give you better service and save you money. Trade-ins accepted. Tell me what you have to trade, and let's make a deal.

Besides having all amateur receivers and transmitters, I also have a complete stock of all other amateur apparatus and parts, also test equipment, etc. I have real bargains in the really good war surplus such as SCR-211's, BC-610, BC-342, BC-348, BC-312, parts, etc. Write, phone, wire or visit either of my stores.

BOB HENRY  
WOARA

## HENRY RADIO

BUTLER, MISSOURI AND  
LOS ANGELES 25, CALIF.

"WORLD'S LARGEST DISTRIBUTORS  
OF SHORT WAVE RECEIVERS"

70

# Home Built TRF RECEIVER

By JAMES W. HOSKINS\*

*Construction details for a 4-tube receiver covering the range from 545 to 1580 kc. Simplicity makes this unit suitable for the beginner or radio experimenter.*

THIS radio receiver has been designed and tested so that a simplified model may be constructed by anyone who carefully studies the drawing and pictures. The circuit is so designed that it eliminates the usual "bugs" encountered in so-called simple receivers. It is also designed to be used in making various tests and measurements for a practical course in radio servicing. This is accomplished by building the receiver and getting it to work and then substituting defective parts and making the necessary measurements to determine what effect the defective part or parts have on the receiver. The circuit as shown in the diagram of Fig. 1 uses a 6D6 tube as a screen grid r.f. amplifier. A 6C6 tube is used as an infinite impedance detector, since this type of detector actually adds considerable amplification to the signal as well as performing its regular duty of rectifying the r.f. voltage. A 42 tube as a power amplifier further amplifies the audio signal so as to have enough power to drive a speaker. An 80 tube, which rectifies high voltage a.c., supplies the "B" voltage for the receiver.

The parts for the receiver may be all new parts, if available, or may be salvaged from old receivers. If a

power supply is available the power transformer and the 80 tube may be eliminated from the receiver. To connect the power supply to the receiver connect "B" plus to the filament of the 80, and "B" minus to the center tap of the high-voltage winding. The filament voltage is connected to the chassis of the receiver and to the other side of the filament winding of the transformer. These connections refer to the diagram but in the discussion dealing with the construction of the receiver the power transformer will be omitted.

In the construction of the receiver it is necessary to assemble the parts that are mounted on the chassis first. If a blank chassis is used it will be necessary to drill it for the various parts such as tube sockets, etc. Any salvaged parts which are used should be tested to make sure that they are in working order before installation is made. The filament circuit and the other a.c. circuits should be wired first so as to get the leads on the bottom of the chassis to prevent the other parts from picking up 60-cycle hum. It is necessary to keep all the grid leads as

\* Reprinted in part from Sept., 1944, issue of *Industrial Arts and Vocational Education*.

Front-top view of chassis assembly showing correct placement of parts.

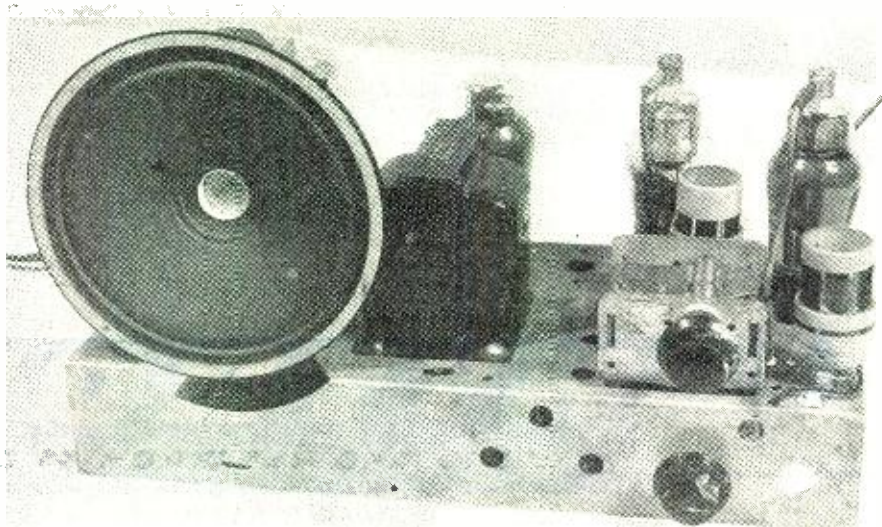

RADIO NEWS



# MAKING TUBES IS EASY..

*If YOU  
KNOW  
HOW!*

FUNDAMENTAL AGING CIRCUIT

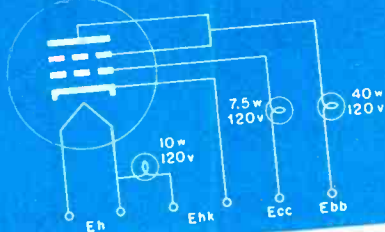

AGING SCHEDULE FOR HYTRON 50L6GT

Step	Min-utes	Eh a-c	Ehk a-c	Ecc d-c	Ebb d-c
1	5	50	110	0	0
2	3	70	110	0	0
3	5	80	110	0	0
4	3	80	110	0	0
5	5	70	0	120	120
6	4	0	0	0	0
7	5	50	0	-10	120

Electrode potentials are varied as shown in the schedule. Actual voltages at the socket depend on currents drawn through the incandescent lamps used as economical, interchangeable current-limiting resistors.

Operations performed in seven steps are: (1) discovery of heater-cathode shorts (2) beginning of cathode processing to stabilize emission (3) further seasoning and burning off of h-k leakage (4) h-k potential increased to eliminate leakage (5) grid, screen, and plate potentials applied to complete de-gassification (6) cooling off period (7) normal potentials applied to pre-heat for test.

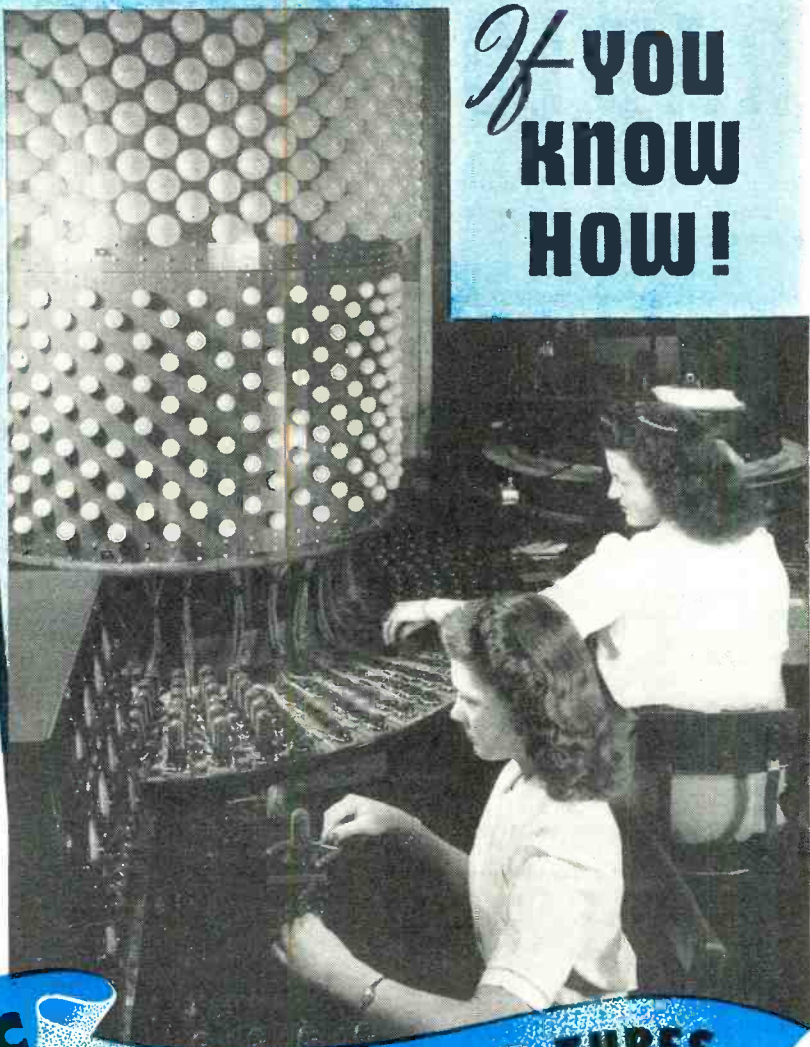

## AUTOMATIC AGING FOR BETTER TUBES

Yes, radio tubes also must be "aged in the wood." Aging activates the cathode under accelerated life conditions, just before test. In the fundamental aging circuit shown, final seasoning and de-gassification stabilize characteristics in accordance with the carefully planned aging schedule.

Formerly tubes were plugged into long aging racks. An operator, equipped with the schedule and a timer, adjusted electrode potentials throughout the aging cycle. The human element resulted in errors of timing and switch manipulation.

Hytron's new automatic aging wheel minimizes human error. A motor drives a mechanically-indexing horizontal wheel on which 30 radial sections of

12 tubes each are slowly rotated. Brushes contacting commutator segments automatically apply electrode potentials. The wheel itself requires no operator. The final basing machine operator feeds the wheel. Tubes already pre-heated are removed by the test operator.

Other features of the aging wheel are elimination of needless handling, fast and steady pacing of the work, easy servicing, and readily interchangeable load lamps.

To you this automatic aging wheel means economical, more uniform tubes with stable electrical characteristics. Again Hytron know-how takes a forward step by making your tubes easier and better.

SPECIALISTS IN RADIO RECEIVING TUBES SINCE 1921

# HYTRON

RADIO AND ELECTRONICS CORP.

MAIN OFFICE: SALEM, MASSACHUSETTS





# Liberty Leads in RADIO PARTS and EQUIPMENT

## SIGNAL CORPS JACK BOX

BC-1366

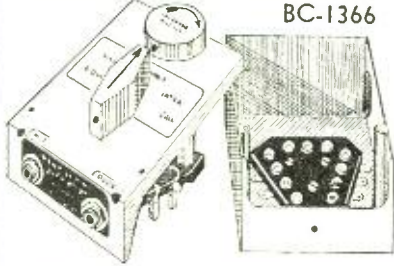

Cast aluminum box held together by 11 banana plugs; 2 jacks, 1 single and 1 double circuit, potentiometer, and double deck hand switch. Single unit 59c. Lots of 10 45c. Lots of 100 38c.

## SIGNAL CORPS RADIO RECEIVER

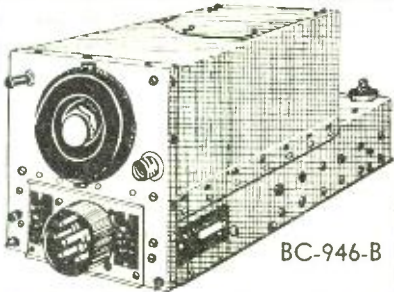

BC-946-B

Broadcast band from 520 to 1500 Kc, tube complement: 3-12SK7, 1-12SR7, 1-12A6, 1-12K8; can be used with 24V dynamotor supplying A and B power; can be converted to AC or DC or 32 Volt sets; 3 stages of I.F. used. Uses 3 gang condenser. Complete with tubes and schematic. \$16.95

## RECORD CHANGERS

Detroit—late model ..... \$16.50 net  
Crescent—late model ..... \$17.50 net

## RADIO KITS

6 Tube "Super Het" ..... \$14.95  
5 Tube "Super-Het" AC-DC... \$12.95  
Special 5 Tube "Super Het" with Slide Rule Dial ..... \$19.95

## OIL FILLED CAPACITORS

2 mfd-1000 V.	\$1.60
4 mfd-1000 V.	\$2.20
8 mfd-1500 V.	\$2.80
8 mfd-600 V.	\$1.90
2 mfd-1500 V.	\$2.20

## VOLUME CONTROLS

50 ohm	10M ohm	200M ohm
100 ohm	20M ohm	1 meg
700 ohm	40M ohm	2 meg
1000 ohm	50M ohm	25 meg ohm
5000 ohm	100M ohm	Your cost 25c ea.

Duals—your cost 35c each.  
100M-100. meg ohm 100 meg-15 ohm  
25% Deposit with order. Minimum order \$2.00.

# LIBERTY SALES CO., INC.

115 WEST BROADWAY • NEW YORK 13, N. Y.

# Parts Lists

(FOR CIRCUIT DIAGRAMS APPEARING ON PAGES 62 AND 63)

## UNITED MODELS 980744, 980745

Part No.	Code and Description
7233313	1—47 $\mu$ fd. molded cond.
1215188	2—56 $\mu$ fd. molded cond.
7240577	3—120 $\mu$ fd. molded cond.
7230893	4—150 $\mu$ fd. molded cond.
7236105	5—220 $\mu$ fd. molded cond.
7240566	6, 7—560 $\mu$ fd. molded cond.
7236134	8—.0015 $\mu$ fd., 800 v. cond.
7240578	9—.0025 $\mu$ fd., 400 v. cond.
7230912	10—.005 $\mu$ fd., 600 v. cond.
1208600	11—.01 $\mu$ fd., 600 v. cond.
1211232	12—.025 $\mu$ fd., 400 v. cond.
7230592	13—.05 $\mu$ fd., 600 v. cond.
1207908	14—.1 $\mu$ fd., 400 v. cond.
7240579	15—.2 $\mu$ fd., 400 v. cond.
7236621	16—.5 $\mu$ fd., 200 v. cond.
7236075	17—.015/.015 $\mu$ fd., 1500/1500 v. tub. cond.
7240612	18—20/20 $\mu$ fd., 400/400 v. elec. cond.
7238553	19—20/20/20 $\mu$ fd., 25/25/25 v. elec. cond.
1213217	20, 21, 22—100 ohm, $\frac{1}{2}$ w. res.
1213224	23, 24, 25—330 ohm, $\frac{1}{2}$ w. res.
1214543	26—680 ohm, $\frac{1}{2}$ w. res.
1213237	27—1500 ohm, $\frac{1}{2}$ w. res.
1214573	28—1800 ohm, 2 w. res.
7237595	29—15,000 ohm, 1 w. res.
7233653	30—15,000 ohm, 2 w. res.
1214550	31—22,000 ohm, $\frac{1}{2}$ w. res.
1213342	32—27,000 ohm, 1 w. res.
1213844	33—68,000 ohm, $\frac{1}{2}$ w. res.
1214555	34—220,000 ohm, $\frac{1}{2}$ w. res.
1214557	35—330,000 ohm, $\frac{1}{2}$ w. res.
1213282	36, 37—1 megohm, $\frac{1}{2}$ w. res.
1214563	38—2.2 megohm, $\frac{1}{2}$ w. res.
7240519	40—Power trans. assembly
7240464	41—Audio pack driver and output trans. assembly
7238546	42—First i.f. trans. assembly
7240467	43—Second i.f. trans. assembly
7240251	61—Antenna choke coil (part of tuner assembly)
7232957	62—330 $\mu$ fd. molded cond. (part of tuner assembly)
7238879	63—470 $\mu$ fd. molded cond. (part of tuner assembly)
7242984	64—Antenna trimmer (part of tuner assembly)
7244037	65—Dual trimmer (part of tuner assembly)
7255725	66—Compensating (part of tuner assembly)

## ADMIRAL—MODELS 6E1, 6E1N

Part No.	Code and Description
60B8-104	R <sub>1</sub> —100,000 ohm, $\frac{1}{2}$ w. res.
60B8-224	R <sub>2</sub> —220,000 ohm, $\frac{1}{2}$ w. res.
60B8-473	R <sub>3</sub> —47,000 ohm, $\frac{1}{2}$ w. res.
60B2-475	R <sub>4</sub> , R <sub>5</sub> , R <sub>6</sub> —4.7 megohm, $\frac{1}{2}$ w. res.
60B2-335	R <sub>7</sub> —3.3 megohm, $\frac{1}{2}$ w. res.
60B9-503	R <sub>8</sub> —50,000 ohm, $\frac{1}{2}$ w. res.
75B1-100	R <sub>9</sub> —1 megohm vol. control
60B2-156	R <sub>10</sub> —15 megohm, $\frac{1}{2}$ w. res.
60B2-105	R <sub>11</sub> —1 megohm, $\frac{1}{2}$ w. res.
60B2-225	R <sub>12</sub> —2.2 megohm, $\frac{1}{2}$ w. res.
61A2-2	R <sub>13</sub> —22 ohm, wire-wound, $\frac{1}{2}$ w. res.
61A3-5	R <sub>14</sub> —2450 ohm, wire-wound, 5 w. res.
60B8-152	R <sub>15</sub> —1500 ohm, $\frac{1}{2}$ w. res.
60B8-561	R <sub>16</sub> —560 ohm, $\frac{1}{2}$ w. res.
60B8-221	R <sub>17</sub> —220 ohm, $\frac{1}{2}$ w. res.
60B8-121	R <sub>18</sub> —120 ohm, $\frac{1}{2}$ w. res.
64B1-32	C <sub>1</sub> —.05 $\mu$ fd., 200 v. cond.
64B1-28	C <sub>2</sub> —.25 $\mu$ fd., 200 v. cond.
65B1-9	C <sub>3</sub> —.00042 $\mu$ fd. mica cond.
65B5-22	C <sub>4</sub> , C <sub>11</sub> —.00025 $\mu$ fd. mica cond.
64B1-25	C <sub>5</sub> , C <sub>6</sub> , C <sub>9</sub> , C <sub>10</sub> , C <sub>12</sub> —.01 $\mu$ fd., 400 v. cond.
65B5-11	C <sub>7</sub> —.00005 $\mu$ fd. mica cond.
65B5-3	C <sub>8</sub> —.000015 $\mu$ fd. mica cond.
64B1-9	C <sub>13</sub> —.002 $\mu$ fd., 600 v. cond.
67C7-42	C <sub>14a</sub> , C <sub>14b</sub> , C <sub>14c</sub> —50/30/100 $\mu$ fd., 150/150/25 v. elec. cond.
64A2-1	C <sub>15</sub> —.2 $\mu$ fd., 400 v. cond.
64B1-22	C <sub>16</sub> —.05 $\mu$ fd., 400 v. cond.
66A12-5	C <sub>17</sub> —Antenna trimmer
68B4	C <sub>18</sub> —Osc. Trimmer (part of gang)
72B9-2	C <sub>19</sub> —Condenser gang
72B10-2	T <sub>1</sub> —First i.f. trans. T <sub>2</sub> —Second i.f. trans. T <sub>3</sub> —Output trans.

## GENERAL ELECTRIC—MODEL 250

Part No.	Code and Description
URD-212	R <sub>1</sub> , R <sub>11</sub> —1 megohm, $\frac{1}{2}$ w. res.
URD-105	R <sub>2</sub> , R <sub>12</sub> —220,000 ohm, $\frac{1}{2}$ w. res.
URD-089	R <sub>3</sub> , R <sub>10</sub> —47,000 ohm, $\frac{1}{2}$ w. res.
URD-081	R <sub>4</sub> —22,000 ohm, $\frac{1}{2}$ w. res.
URD-067	R <sub>5</sub> —5600 ohm, $\frac{1}{2}$ w. res.
URD-049	R <sub>6</sub> —1000 ohm, $\frac{1}{2}$ w. res.
URD-129	R <sub>8</sub> —2.2 megohm, $\frac{1}{2}$ w. res.

RRC-008	R <sub>10</sub> —.5 megohm vol. control
URD-137	R <sub>11</sub> —4.7 megohm, $\frac{1}{2}$ w. res.
URD-059	R <sub>12</sub> —2700 ohm, $\frac{1}{2}$ w. res.
URD-057	R <sub>13</sub> —2200 ohm, $\frac{1}{2}$ w. res.
URE-053	R <sub>14</sub> —1500 ohm, 1 w. res.
RKG-001	R <sub>15</sub> —7.5 ohm, $\frac{1}{2}$ w. res.
RCT-008	C <sub>1A</sub> , C <sub>1B</sub> , C <sub>2A</sub> , C <sub>2B</sub> , C <sub>3A</sub> , C <sub>3B</sub> —Tuning cond. and trimmers
UCU-040	C <sub>4</sub> —330 $\mu$ fd. mica cond.
UCN-506	C <sub>5</sub> —6.8 $\mu$ fd. ceramic cond.
RCC-028	C <sub>6</sub> , C <sub>12</sub> , C <sub>16</sub> , C <sub>25</sub> , C <sub>32</sub> —.05 $\mu$ fd., 400 v. cond.
UCU-028	C <sub>7</sub> , C <sub>13</sub> , C <sub>19</sub> —100 $\mu$ fd. mica cond.
UCC-030	C <sub>8</sub> , C <sub>17</sub> —.1 $\mu$ fd., 400 v. cond.
UCC-039	C <sub>9</sub> , C <sub>21</sub> , C <sub>22</sub> —.005 $\mu$ fd., 600 v. cond.
UCC-041	C <sub>24</sub> —.02 $\mu$ fd., 600 v. cond.
RCE-007	C <sub>28A</sub> , C <sub>28B</sub> , C <sub>28C</sub> —15/15/1200 $\mu$ fd., 150/150/1.5 v. elec. cond.
RCC-070	C <sub>29</sub> , C <sub>30</sub> —.5 $\mu$ fd., 120 v. cond.
RCC-073	C <sub>31</sub> —.003 $\mu$ fd., 1500 v. cond.
RCC-069	C <sub>33</sub> —.5 $\mu$ fd., 120 v. cond.
RLI-008	L <sub>1</sub> —Loop antenna assembly
RLB-002	L <sub>2</sub> —R.f. coil
RLC-008	L <sub>3</sub> —Osc. coil
RLF-001	L <sub>4</sub> , L <sub>5</sub> —Vibrator and B+ choke
RLF-002	L <sub>6</sub> —Fil. choke
RTL-001	T <sub>1</sub> —First i.f. trans.
RTL-012	T <sub>2</sub> —Second i.f. trans.
RTO-007	T <sub>3</sub> —Output trans.
RTC-001	T <sub>4</sub> —Rectifier trans.
RTV-001	T <sub>5</sub> —Vibrator trans.

## HOWARD—MODEL 920

See Circuit Diagram for Component Part Values

## FARNSWORTH—MODELS EC-260, EK-262, EK-263, EK-264, EK-265

Part No.	Code and Description
77214	1—100,000 ohm, $\frac{1}{2}$ w. res.
77211	2—4700 ohm, $\frac{1}{2}$ w. res.
77266	3—22,000 ohm, $\frac{1}{2}$ w. res.
77261	4—470 ohm, $\frac{1}{2}$ w. res.
77155	5—12,000 ohm, 2 w. res.
77270	6—2.2 megohm, $\frac{1}{2}$ w. res.
77216	7—220,000 ohm, $\frac{1}{2}$ w. res.
77213	8—47,000 ohm, $\frac{1}{2}$ w. res.
77217	9—470,000 ohm, $\frac{1}{2}$ w. res.
77273	10—6.8 megohm, $\frac{1}{2}$ w. res.
77174	11—270 ohm, 1 w. res.
77258	12—100 ohm, $\frac{1}{2}$ w. res.
77301	14—2200 ohm, 2 w. res.
25196	16—.05 $\mu$ fd., 600 v. cond.
25215	17—.1 $\mu$ fd., 600 v. cond.
25194	18—.01 $\mu$ fd., 600 v. cond.
25183	20—.005 $\mu$ fd., 600 v. cond.
25185	21—.002 $\mu$ fd., 600 v. cond.
25184	22—.003 $\mu$ fd., 600 v. cond.
25031	23—.005 $\mu$ fd., 600 v. line buffer
25188	25—100 $\mu$ fd. mica cond.
25187	26—240 $\mu$ fd. mica cond.
25193	27—47 $\mu$ fd. mica cond.
25180	28—30/20/20 $\mu$ fd., 350/300/250 v. elect. cond.
15136	30—Gang cond. and drive drum
78071	31—Vol. control
90148	32—Tone control and phono sw.
38484	33—Wave trap
38483	34—Osc. coil
38536	35—First i.f. trans.
38537	36—Second i.f. trans.
94025	39—Power trans.
94197	39—Output trans. (EK-260, EK-265)
94198	39—Output trans. (EK-262)
94199	39—Output trans. (EK-263, EK-264)
26032	40—Antenna trimmer

## DETROLA—MODELS 571A, 571B

Part No.	Code and Description
BR17B223	R <sub>1</sub> —22,000 ohm, 1/3 w. res.
BR17B156	R <sub>2</sub> —15 megohm, 1/3 w. res.
BR17B224	R <sub>3</sub> —220,000 ohm, 1/3 w. res.
BR17B335	R <sub>4</sub> —3.3 megohm, 1/3 w. res.
BR17B685	R <sub>5</sub> —6.8 megohm, 1/3 w. res.
BR17B474	R <sub>6</sub> , R <sub>8</sub> —470,000 ohm, 1/3 w. res.
BR16C151	R <sub>7</sub> —150 ohm, $\frac{1}{2}$ w. res.
B-9051-1	R <sub>9</sub> —500,000 ohm, vol. control & sw.
BM78A101	C <sub>1</sub> —100 $\mu$ fd. mica cond.
BD210503	C <sub>2</sub> —.05 $\mu$ fd., 200 v. cond.
BC31B503	C <sub>3</sub> —.05 $\mu$ fd. molded cond.
BD410104	C <sub>4</sub> —.1 $\mu$ fd., 400 v. cond.
BD410103	C <sub>5</sub> —.01 $\mu$ fd., 400 v. cond.
BM78A471	C <sub>6</sub> —470 $\mu$ fd. mica cond.
BD410203	C <sub>7</sub> , C <sub>8</sub> —.02 $\mu$ fd., 400 v. cond.
C-51155-1	C <sub>9</sub> —2-section var. cond.
A-8948	C <sub>10</sub> —40/20 $\mu$ fd., 150/150 v. elec. cond.
B-51243	L <sub>1</sub> —Loop antenna
B-51159	L <sub>2</sub> —Osc. coil assembly
B-51010	T <sub>1</sub> —First i.f. trans.
B-51011	T <sub>2</sub> —Second i.f. trans.



# Radio Parts are EASY to identify

when you use  
**PHOTOFACT FOLDERS**

**PARTS LIST AND DESCRIPTIONS**

**TUBES**

**CAPACITORS**

Capacity values given in the rating column are in mfd. for Electrolytic and Paper Capacitors, and in mmfd. for Mica and Ceramic Capacitors.

ITEM No.	RATING	TRUETONE PART No.	MALLOY PART No.	REPLACEMENT DATA	SPRAGUE PART No.	AEROVOX PART No.	CORNELL-DUBIER PART No.	IDENTIFICATION CODES AND INSTALLATION NOTES
	CAP. VOLT.							
7(A)	40 150	B00256	FF306*	DY-40+20-150	EL-24	AF88D	UP3515	■ Filter*
8	.2 400	.502158	TP429	S-4-2	TC-2	484-.2	DT4P2	▲ Line Isolating
9	.05 400	.502157	TP426	S-4-05	TC-15	484-.05	DT4S5	Line Filter
10	.01 400	.502151	TP421	S-4-01	TC-11	484-.01	DT4S1	Pwr. Amp. Plate
11	.004 400	.502156	TP407	S-6-004	TC-24	484-.004	DT6D4	Audio Coupling

**CONTROLS**

**RESISTORS**

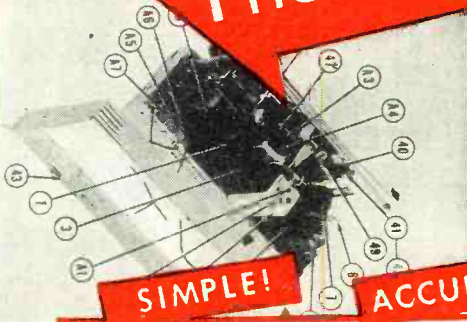

**SIMPLE!**

**ACCURATE!**

**FAST!**

What's your biggest headache when servicing radios? Identifying parts? With PHOTOFACT FOLDERS it's easy to locate and identify any item you want to find. Just look at the Complete Parts List . . . a list that's keyed to clear chassis photographs and a full page, easy-to-read schematic diagram. For instance, the capacitor listing alone gives complete data on capacity, voltage rating, function, replacement types . . . even includes installation notes.

No service problem can stump you when you use PHOTOFACT FOLDERS. They result from the actual examination of the receiver involved, and are not copied from the manufacturer's service data or from looking at his schematics. They tell you everything you need to know about any set manu-  
\*Trade Mark Reg.

factured since January 1, 1946—even to the restringing of dial cords. They do this by means of pictures, full-page schematics, original technical notes that help you work faster, more accurately...easily increase the number of jobs you can do in a week by fifty percent.

PHOTOFACT FOLDERS are sold in sets of 40, each set covering new radios, phonographs, record changers, intercommunication systems, recorders and power amplifiers within a short time after they reach the market. Their cost is only \$1.50 a set, including membership in the Howard W. Sams Institute. No other radio service compares with PHOTOFACT FOLDERS in completeness, accuracy or timeliness. Use the coupon. Mail it to your nearest radio parts supply house.

**PUBLICATION DATES:**  
Set No. 9 . . . . . December 19  
Set No. 10 . . . . . December 29

Cut this out and MAIL IT TO YOUR DISTRIBUTOR. If you do not know his name and address, send it directly to Howard W. Sams & Co., Inc., 2924 East Washington Street, Indianapolis 6, Indiana, and we will see that your nearest distributor gets it. In Canada—write to A. C. SIMMONDS & SONS, 301 King Street East, Toronto, Ontario. Canadian Price \$1.75.

PLEASE PRINT

Send Set No. 10  Send Set No. 9  
(Circle one or more of following) Send Set No. 8, 7, 6, 5, 4, 3, 2, 1 (at \$1.50 a set)

Send me a DeLuxe Binder (at \$3.39)  
My (check) (money order) (cash) for \_\_\_\_\_ is enclosed. (If you send cash, be sure to use registered mail)

Name \_\_\_\_\_

Address \_\_\_\_\_

City \_\_\_\_\_ Zone \_\_\_\_\_ State \_\_\_\_\_

Company Name \_\_\_\_\_

My Distributor's Name \_\_\_\_\_

City \_\_\_\_\_

## In Each PHOTOFACT FOLDER You Get—



1. A cabinet view of the receiver to help you establish identity and control functions.
2. A top view of chassis and speaker to identify component parts and alignment points.
3. A bottom view of chassis and/or accessories.
4. A complete list giving keyed reference to all parts, alignment and schematic diagram.
5. A complete, full-page schematic diagram.
6. Stage gain measurements listed on the schematic diagram.
7. A complete voltage and resistance analysis chart for rapid check of operational values.
8. Complete alignment instructions on the receiver consistent with the keyed alignment points indicated on photographs.
9. Dial cord diagram and restringing instructions.
10. Complete disassembly instructions where required.

HOWARD W. **Sams** & CO., INC. **RADIO PHOTOFACT SERVICE**

In Canada—write to A. C. SIMMONDS & SONS, 301 King Street East, Toronto, Ontario





# LOOK at this Value!

Portable Voice and Code Radio

## RECEIVER - TRANSMITTER

BC-654-A is a combined transmitter and receiver designed for portable or vehicular operation. The frequency range of both transmitter and receiver is continuous from 3700 to 5800 kilocycles; all stages gang tuned by anti-back lash worm gear dial mechanisms. The BC-654-A is 18" wide, 14" high, and 9 1/2" deep. Weight 4 3/4 pounds. Power required for Receiver—1.5, 45, and 90 volts D.C. Power required for Transmitter—1 1/2, 6, 51, 84 volts D.C. and 500 volts D.C. at 160 ma. Operates from Dynamotor PE-103-A.



ONLY  
22.95  
AS IS

Complete  
with case  
less  
dynamotor

One-third deposit with order, balance C.O.D., F.O.B. shipping point. For check with order, shipping charges prepaid.

Balance of stock being closed out at this low price

## DELUXE 25-WATT AMPLIFIER

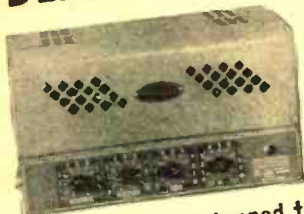

Universal Output tapped to match any Speaker. Wide Range Tone Control.

Beautiful Gray Crackle Finish. Suitable for all but the very largest installations. 2—6L6G Tubes in PUSH-PULL to develop a full 25 watts of output. 1—7N7 Driver Tube. 3—7C7 as microphone and phonograph inputs. 1—5U4G Rectifier. 2—Microphone Inputs. 1—Phonograph Input.

It's a  
"Buy"  
at  
39.95

# ▶▶▶ PARTS

## AND RADIO EQUIPMENT

Net Prices		Net Prices	
Sprling Auto Antennas—		4-Piece GC Alignment Kit.....	\$1.80
25 to 66 inches.....	\$ 2.95	5-Piece GC Alignment Kit.....	3.90
35 to 96 inches.....	3.50	Deluxe GC Alignment Kit.....	4.50
25 to 80 inches.....	3.50	Jensen Paging Speakers.....	5.85
Vertrod Antennas.....	3.30	8-Watt, Tone-Pak Amplifier with tubes.....	19.50
RCA Television-FM Antenna (Dipole with reflectors).....	9.00	BC-348-R Receiver.....	57.00
RCA Bright Picture Television Wire, per foot.....	.05	Clark PA-10—10-watt Amplifier.....	37.50
AC-DC Hanks.....	.18	Clark PA-20—20-watt Amplifier.....	57.50
Rubber Covered Lead-in Wire, per foot.....	.01	Clark PA-30—30-watt Amplifier.....	108.50
Line Cords.....	.22	Astatic JT-30 Microphone with Stand.....	10.17
Multitester, RCP Model 447.....	17.95	Astatic DN-HZ Microphone with Stand.....	14.76
Sparx Signal Tracer.....	39.90	Electro-Voice "Comet" Mikes.....	7.95
Simpson 260 Multimeter.....	38.95	Mike and stand 1-piece moulded gray plastic.....	
Triplet 666H Multimeter.....	20.00	Electro-Voice Floor Stands (satin chrome).....	13.50
Triplet 666H Leather Case.....	4.00	Model "P" Battery Eliminators.....	9.00
Triplet Model 2405.....	58.50	Feller Signal Tracer.....	29.95
Silver CR Bridge, No. 901.....	49.90	Jan 813 Tubes.....	9.50
Clarkstan Needle Pressure Gauges..	2.10		

"IT'S D & H FOR DEPENDABLE PARTS SERVICE"

# D. & H. DISTRIBUTING CO., INC.

211 S. Cameron Street  
Harrisburg, Penna.

PARTS DIVISION

31 East Lee Street  
Baltimore 2, Md.

As a half-wave rectifier it carries a rating of 6 or 12 volts a.c. at 3 ma. d.c. or 12 volts a.c. at 5 ma. d.c. As a double half-wave unit, it is rated at 6 volts a.c. for either 3 or 5 ma. d.c. In its full-wave, back-to-back, applications the unit is rated at 6 or 12 volts a.c. at 5 ma. d.c. and as a full-wave bridge it is rated at 6 volts a.c., 5 ma. d.c.

The three-inch flexible leads are color-coded and presoldered to prevent overheating during assembly. Any unused leads are simply clipped off after the circuit has been tested.

A circuit sheet containing complete schematic data is available from *Bradley Laboratories, Inc.*, 82 Meadow Street, New Haven, 10, Conn.

### MIDGET CAPACITOR LINE

A complete line of flat midget capacitors, Type ZN, has recently been announced by *Cornell-Dubilier Electric Corporation* for applications in ultra compact electronic devices.

These units are especially designed for hearing aids and pocket radios. Be-

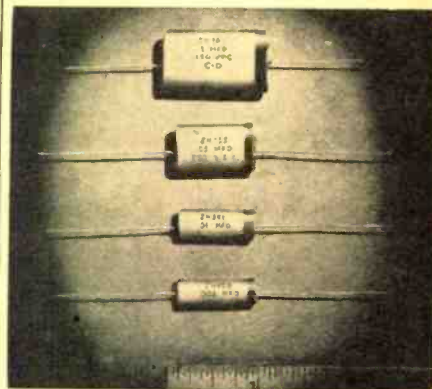

cause this line is flat, they are ideally suited for circuit applications where space is at a premium.

Type ZN midget capacitors are non-inductively wound with Kraft paper and thoroughly impregnated with halowax. The leads are anchored to the capacitor body. Standard ZN types include units from 1/4" x 1/4" x 3/32" to 1" x 5/8" x 3/16". The values range from .0001 µfd. to .1 µfd., d.c. rated voltages from 150 to 600 volts.

Complete details of the Type ZN line will be furnished by *Cornell-Dubilier Electric Corporation*, South Plainfield, New Jersey.

### AMPLIDYNE BOOSTER INVERTER

The operation of radios, movie equipment, public-address systems, fluorescent lighting and improved air conditioning for American railroads has received a new impetus with the announcement by *General Electric Company* of the development of a new amplydine booster inverter which will provide an ample and economical supply of 60 cycle a.c.

This new equipment changes the current supplied by the railway car's axle-driven generator or battery from d.c. to a.c. and gives constant voltage and frequency without excessive loss.

The amplydine booster inverter con-

(Continued on page 94)

RADIO NEWS





**RADIO  
TUBES**

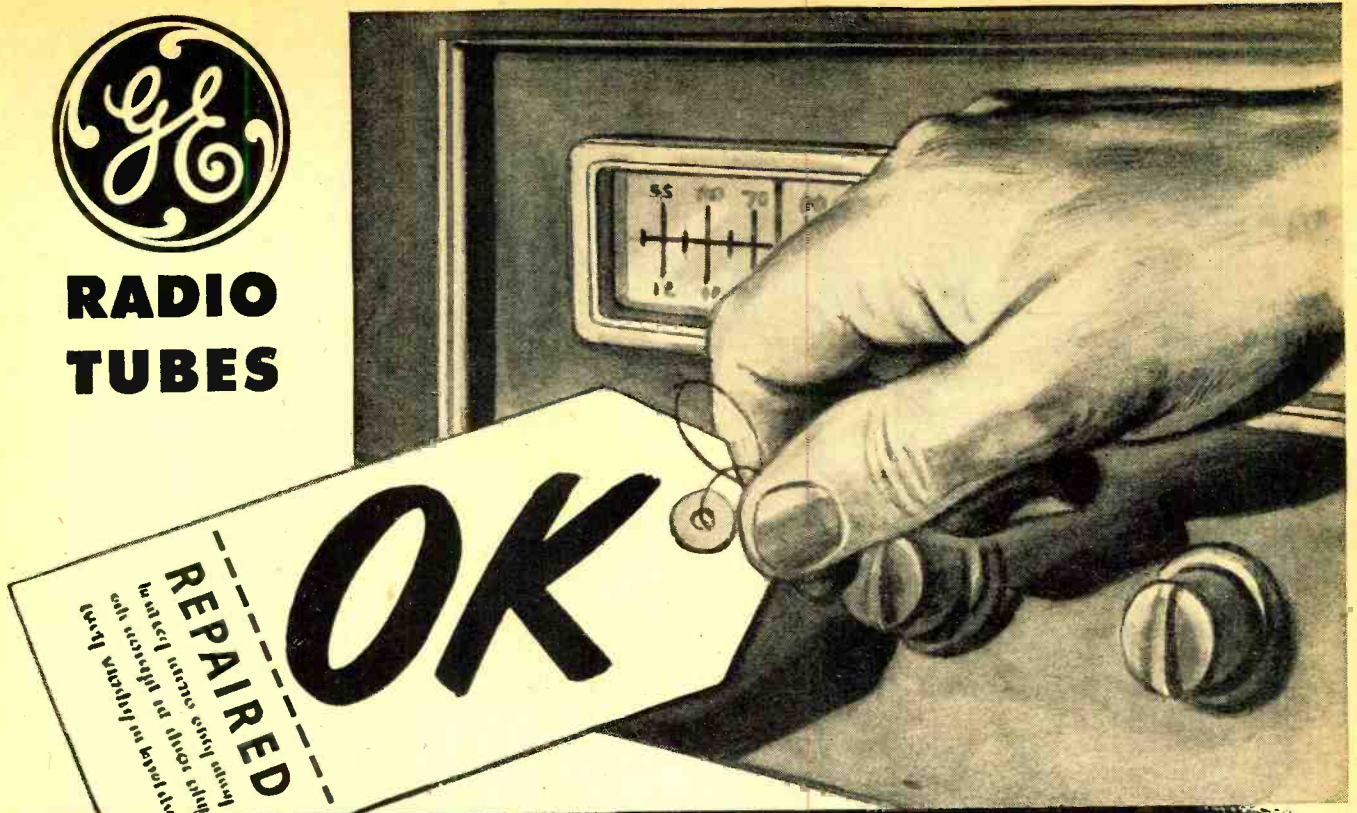

**A REPAIR JOB WELL DONE!**

*... That's what "OK" means when  
the tubes you've installed are G-E's*

**F**IRST off, you've pleased your customer by putting General Electric tubes in his set he gave you to repair. For the G-E monogram is more than a familiar symbol to him—it stands for **QUALITY**.

Second, you've done yourself a good turn, because G-E radio tubes *won't let you down*. The set you've just tagged "OK" will play better than ever, and will keep giving the kind of satisfaction that builds friendship for you and your shop.

When your client is asked to recommend a radio repair source (as happens regularly) he'll give *your* name. That's the sort of helpful person-to-person advertising that makes your business grow, and fattens your profit-account.

So that your radio service always may enjoy top standing in your community ... replace faulty tubes with high-quality, long-lived G-E's—**THE BEST!** *Electronics Department, General Electric Company, Schenectady 5, N. Y.*

*G.E.'s fact-filled Tube Characteristics Book ETR-15 will help you in your radio service work. Send for your copy. It's free!*

**GENERAL  ELECTRIC**  
176-F1-8880

FIRST AND GREATEST NAME IN ELECTRONICS





# MONTHLY SPECIALS

## SURPLUS BARGAINS

- 5 TUBE AMPLIFIER (Bendix). 2-6H6. 3-6SN7. Orig. used with remote indicator. 27V. DC-110V. 400 cycles. Black crackle shock mtd. case & fitted chassis. 7 3/4" x 5 1/2" x 4 1/2". Shpr. wt. 7 lbs. Less tubes. \$2.49
- Frequency Meter Tech. Manual (Navy). Theory & operation. 38 illust. & diagrams. 58 pp. F.M. Technical Manual (Army). 86 illust. 49 diagrams. 240 pp. .39
- Ceramic Coil Forms. Low loss ribbed & grooved, with lead & mtg. holes. 3/16" wall. O.D. 2 3/8". 1 .19
- EARPHONE HEADBANDS (Army HS-33). Leather covered frame, adj. forks. With PL-54 & dpl. cord .39
- PL-54 plug & 13" tipped dble. phone cord .19
- JK-26 ext. jack for PL-54. Bakelite shell .25
- Earphone cushions, sponge rubber for Army Type HS-33 Phones. Each. .10

16" N.B.C. RECORDINGS. Each contains 2 complete 15 min. "Voice of the Army" dramatic programs with music. Over 50 different titles, such as: On the Beam, Day for History, Time Runs Out, etc. 33 1/2 RPM 5 asstd. records. \$1.49

POWER RHEOSTAT. 15 ohm-30 watt. Cast alum. shell, porcelain insul. Suitable control for filaments, electric trains, motors, etc. \$0.98

4 TUBE AMPLIFIER (2-7C5, 7P7, 7Y4). Used as electronic supercharger control. 110V. 400 cycle. Black crackle finish case & fitted slide-in chassis. Contains: Power Trans., 7 mica & oil cond., 7 resistors, 4 local sockets plus other components, worth several times the price. 8 3/4" x 4 1/2" x 3 3/4". Less tubes. 1.49

SHUNTS-MULTIPLIERS. 1 1/2" precision wire wound. Ohmages: 2.35, 24.5, 90, 405, 2500, 3330, 5995, 7800, 9800, 18K, 30K, 36.5K, 50K or 400K. .35

## ALNICO MAGNETS

- #1 Bar. 8 1/2" x 1/2" x 1/2". \$0.39
- Bar in shorter lengths, per inch. .12
- #2 Face 1 1/4" x 1 3/4" x 3/8" high. .98
- #3 Heavy duty bar. 2 1/2" x 1 1/2" x 5/16" thick. .98
- #4 Face 3/4" x 5/8" x 3/8" high. .39
- #5 Polished 7/8" x 9/16" x 3/8" high. .35
- #6 Polished bar. 9/16" x 1/4" x 1/4" - 20 for. 1.00
- #7 Face 1 1/2" x 1 1/2" x 3/8" high. .10
- #8 ALNICO V horseshoe, poles 3/8" sq. 1 1/2" high. .75
- #9 ALNICO V horseshoe, poles 9/16" sq. 1 1/2" high. .98

SELVYN GENERATORS (#2J1F3). Used in pairs as transmitter & follower on 45V. 60 cycles. 2 1/4" x 4". Shpr. wt. 31 lbs. Per pair. \$3.95

32 mfd./450 V. tubular electrolytic. 2 1/2" x 4". 79

20 mfd./200 V. tubular electrolytics. 6 for. 1.00

RADIOMAN'S HARDWARE TREASURE. Over 1000 asstd. nuts, screws, washers, lugs, etc. PLUS 36 compartment cardboard kit box. \$0.59

TUBES: Perfect condition, but not in sealed cartons. Guaranteed 90 days. 4" to 12" sizes. #27, 56 or 6F6-29c; #24, 42, 77, 89, 8A7, 8C8, 6D6, 6K6, or 6K7. \$0.39

Limited quantity of British (Marconi, Cosmor) and French (Dario) tubes. Write for types and prices.

Brand new RCA UX-200 tubes in sealed cartons (detector-amplifier). 8 for. \$1.00

## SERVICEMEN'S KITS

- #1-R.F. Antenna & Osc. coils. 10 asstd. \$0.98
- #2-Speaker Cones. 12 asstd. 4" to 12" moulded & free-edge (magnetic incl.). Less voice coil. 2.00
- #3-BAKELITE MICA CONDENSERS. 50 asstd. .00005 to .2 mfd. 200-600WV. Clearly marked. 2.95
- #4-TUBULAR BY-PASS CONDENSERS. 50 asstd. .0005 to .25 mfd. 200 to 600WV. Standard brands. including multi-section, paper & can types. 2.49
- #5-Electrolytics. 10 asstd. including multi-section, paper & can types. 1.25
- #6-Dial Scales. 25 asstd. airplane & slide rule (acetate & glass included) 2.98
- #7-Escutcheon Plates. 25 airplane, slide-rule & full-vision types. 2.95
- #8-Knobs. 25 asstd. wood & bakelite, including setscrew & push-on types. 1.00
- #9-Wafer Sockets. 12 asstd. 4 to 7 prong. .25
- #10-Voltage Dividers. 10 asstd. standard multi-tapped, high wattages included. 1.98
- #11-Shield Cans. 15 asstd. for coils, tubes, transformers, etc. 1.00
- #12-Mica Faders & Trimmers. 15 asstd. incl. multiple & ceramic base types. 1.19
- #14-Potentiometers & Controls. 10 asstd. wire-wound & composition. Less switches. 1.49

20 EXPERIMENTAL TUBES. All filament tested including most sizes & base types. \$1.00

UHF BUTTERFLY TUNING CONDENSERS. Silver plated; ball bearing shafts. Ranges: 135-485 M.C. (O.D. 8 1/4") or 140-1200 M.C. (O.D. 2 1/4"). Either. \$2.49

Victor Power Transformer for models R-32, 45, 52 or 75. Unshielded. 5.95

BAKELITE PANELS. 14" glossy brown. 7 1/2" x 10" x 5/8". 79c; 7 1/2" x 14" x 5/8". 85c

ALUMINUM PANELS. 15 1/2" x 14" x 5/8". 1.19

18 1/2" x 11 1/2" x 1/32". 1.29

PROMPT SERVICE ON ALL SPEAKER & PHONO PICK-UP REPAIRS. Minimum order \$2.00. 50% deposit required on all orders. Please add sufficient postage. WRITE DEPT. RN-1.



MAKERS OF CONES AND FIELD COILS  
65-67 DEY STREET, NEW YORK 7, N.Y.  
WORTH 2-0284-5  
12,000 SQ. FT. OF RADIO PARTS

# What's New in Radio

## PERSONAL RADIO

One of the new features of the 1947 Remler "Scotties" is the "invisible" carrying handle which drops down out of sight when the radio is in use.

This new plastic unit, which is made

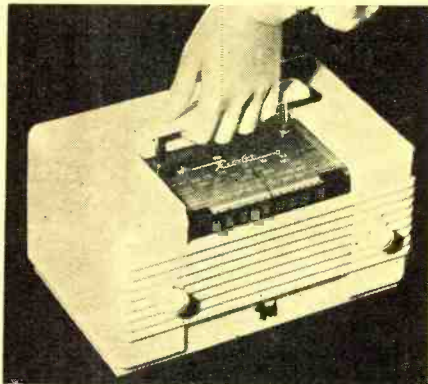

by Remler Company Ltd. of San Francisco, is completely enclosed and dust-proof. The large, easy-to-read dial tunes stations by name. The dial is molded of heavy transparent lucite. The white numerals and colored markers are molded in the underside of the dial and light up against the dark background.

The radio has 5 tubes, including recifier, and is a.c. operated.

Complete information on the "Scotties" and other radios in the Remler line will be furnished by Remler Company Ltd., 2101 Bryant Street, San Francisco 10, California.

## PLUG-IN AMPLIFIERS

A line of "plug-in" amplifiers for broadcast field application has been announced by the RCA Engineering Products Department of Radio Corporation of America.

Revolutionary in design, these amplifiers permit a complete unit to be removed from the rack and another to be installed in its place with no greater effort than that expended in changing an ordinary radio tube.

These new plug-in amplifiers may be removed by pulling a lever near the front of the unit which ejects the unit from its socket and automatically detaches it from the circuit connections.

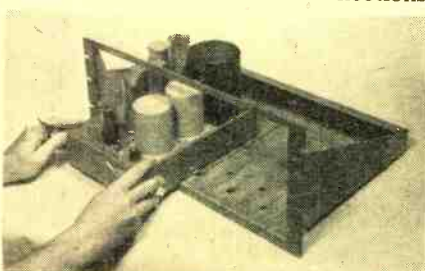

Another unit may be plugged in for operation while the unit which has been removed may be handled without the danger of blowing a fuse or taking risks with the power supply circuits.

A special shelf assembly for mounting in a standard rack has been developed for use with the plug-in amplifiers.

Full information on this piece of broadcast equipment will be furnished by Engineering Products Department of Radio Corporation of America. Address your requests to the RCA Victor Division at Camden, New Jersey.

## "PYLON" FM ANTENNA

RCA Engineering Products Department is responsible for the development and production of a new cylindrical FM antenna which is said to provide higher gain height-for-height than any previous antenna.

Known as the "Pylon" antenna, the new FM radiator is a single-element, mechanically-rigid, self-supporting structure. This antenna requires no additional means of support or mounting, nor are there any arms, loops or circular elements required.

Where high gain is needed for an FM station, additional sections of the antenna can be stacked on top of each other by simply bolting together the end flanges of the pipe-like unit. Since

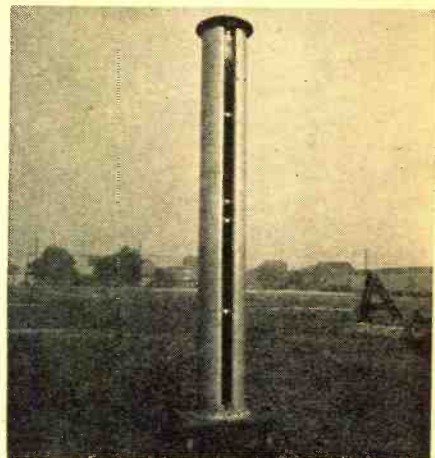

radiation is compressed in the vertical plane, there is a subsequent power increase. Stacking four sections of the "Pylon" results in a power gain of six.

Full engineering details of this unit will be furnished to broadcast engineers, FM station owners, and those charged with the installation and adjustment of FM antennas. Make your request direct to the Engineering Products Department, Radio Corporation of America, RCA Victor Division, Camden, New Jersey.

## REPLACEMENT RECTIFIER

Bradley Laboratories, Inc., of New Haven, Conn., has added a replacement rectifier to its line of copper oxide rectifiers.

The unit, designated as "Coprox" Model CX2E4U, offers a multitude of circuit variations, depending on how two or more of its five leads are used.



Here, and on following pages, are circuit diagrams and parts lists of many new postwar radio receivers. Radio News will bring to you other circuits as quickly as possible after we receive them from manufacturers.

READ WHAT AMATEURS are Saying About Leo's

WRL GLOBE TROTTER  
**TRANSMITTER KIT**



**Field Reports Testify To Its Superior Performance**

**FROM SANDUSKY, OHIO**—“May 1 congratulate you on turning out such a hot little rig as the ‘Globe Trotter.’ It’s amazing the way this ‘lean-power transmitter bucks the heaviest QRM.” Jay Leibach.

**FROM BETHANY, W. VA.**—“I am very well pleased with my WRL Globe Trotter (6L6-807). My first call resulted in a daytime report of 10db over R9 at 60 miles on 75 meter phone. The quality is excellent, and no hum is reported.” J. S. V. Allen W8UNS

**FROM SANDY CITY, UTAH**—“The particular feature of the ‘Globe Trotter’ that appeals to me is its versatility. With a mere flip of a switch emission can be changed to any desired band, and to either CW or PHONE. For the money charged for these sets in these days of high prices for everything else, it really is a buy!” O. W. DeRemer

**IMMEDIATE DELIVERY!**

Many other actual field reports of amateurs using the Globe Trotter testify to its excellent performance. It's the hottest ham equipment on the market today. The WRL Globe Trotter is capable of 40 watts input on C.W. and 25 watts input on phone on all bands from 1500 KC through 28 Megacycles. Incorporates the Tritet Oscillator using a 40 meter Xtal; Heising choke modulation; three bands, all pretuned; 10, 20, and 80 meters; two power supplies, one for 807 final and modulator tubes, one for speech amplifier and oscillator stage.

- 40 WATT INPUT** ..... **\$69.95**  
Cat. No. 70-300
- Complete including all parts, chassis panel, streamlined cabinets, less tubes, coils, and meter.  
**No. 70-312** same as above, wired by our engineers ..... **\$79.50**
- 1 Set Coils, Meter, Tubes ..... **\$15.15 Extra**  
B-19 Tank Sets (3 sets in 1) Government Cost **\$11.030**  
Your Cost, Only ..... **\$59.95**

Place Your Orders Now for WRL's  
**Low Priced "Exciter" Xmitter Kit**

This unit uses the 6L6 regenerative oscillator into a 807 driver or final. Output ranges from 35 to 40 watts. Similar to exciter described in A.R.R.L. Handbook with circuit revisions to give better performance.  
Kit, less Accessories, Cat. No. 70-302 ..... **\$17.95**  
Above kit wired and tested.  
Less Accessories, Cat. No. 70-310 ..... **\$23.95**  
Accessories—Tube, Meter, 1 Set of Coils ..... **\$10.19 Extra**  
Power Supply for above on 3x15x3 chassis in kit form  
Cat. No. 70-334 ..... **\$18.95**  
Wired and tested. Cat. No. 70-336 ..... **\$20.95**

All well-known Receivers available on easy payment plan. Liberal trade allowance. Write us for your wants  
Our Latest Flyer Just Printed!  
Giant Radio Man (Size 3½ ft. x 4½ ft.) ..... **15c**  
Handy Tube-Base-Calculator ..... **25c**  
Tube and Circuit Book ..... **10c**

\*All prices quoted are domestic. Write for export prices.



Formerly Wholesale Radio Laboratories  
Address Dept. RN-1 Council Bluffs, Iowa.

**RADIO NEWS, JANUARY, 1947**

**ADMIRAL MODELS 6E1, 6E1N**

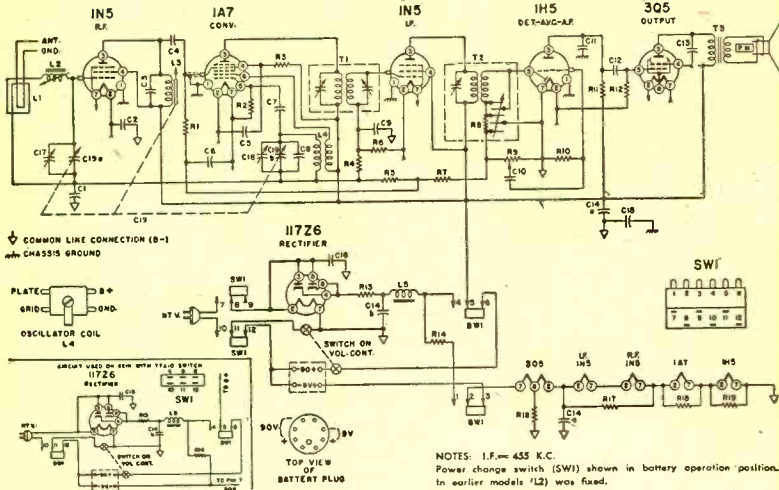

**RADIO NEWS, JANUARY, 1947**

**UNITED MODELS 980744, 980745**

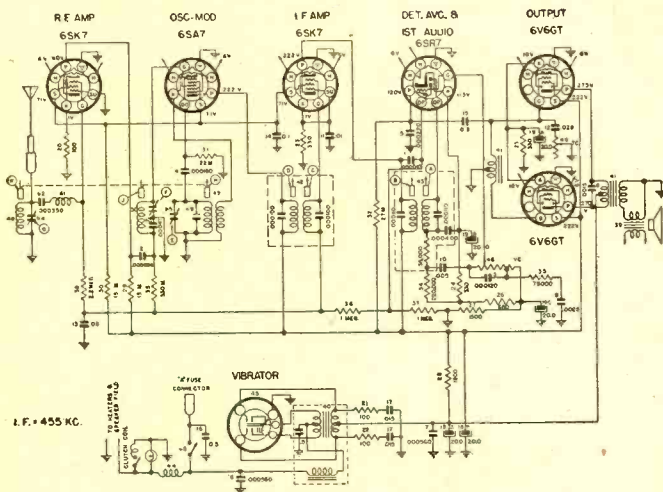

**RADIO NEWS, JANUARY, 1947**

**HOWARD MODEL 920**

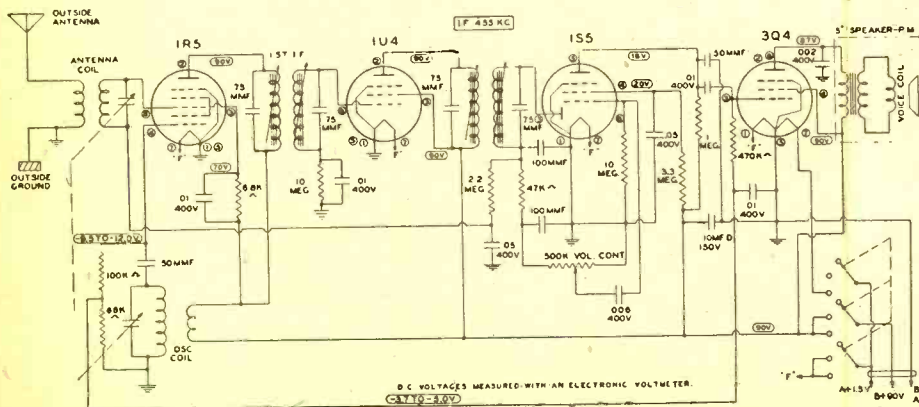



*Skilled Technicians*  
**OF**  
**BY**  
**FOR**  
**RADIO**

OUR young men come to us from every walk of life—from the farm—from the city—rich and poor—many ex-GI's. They represent every race and creed but they do have ONE thing in common.

They're all men OF Radio, BY Radio and FOR Radio. They've grown up with a "cat's whisker" and a set of headphones as playthings. The only lullabies they remember are the ones they heard over Dad's Battery Set, with all the knobs, dials, and switches, when radio itself was an infant.

These young men have never known a world without radio, and they never want to. Radio has molded their minds, provided them with an absorbing hobby and given them the means of earning a good living.

**SKILLED MEN FOR RADIO**

Now, with their training at National Schools behind them, they are prepared to contribute their skill, talent and creative ideas to an industry which is literally a part of them.

We feel fortunate indeed to have had the privilege of awakening the dormant abilities of many men now holding prominent positions in Broadcasting, Communications, Radio Sales and Service, Television and Electronics. And we look forward with pleasure to an ever-broadening educational program, designed to train still more men to fill the thousands of specialized positions radio will require in the future.

During the four decades since we first began to build men for Industry, we have kept accurate student records and compiled unusually complete performance charts. Thus we have acquired a keen insight into the most effective ways to inspire radiominded men to APPLY their training, and to use their creative abilities to the best advantage of themselves and their employers.

**REPORT TO INDUSTRY—FREE!**

You'll be impressed by our methods and observations, as they apply to YOUR personnel problems. You'll welcome an opportunity to learn how we inspire our students to ACTION, how we develop in them those vital traits of character which make them an asset to any employer.

We know you'll want to send for our "Report to Industry." Whether you employ one man or hundreds, you will enjoy and profit by this factual, informative presentation.

Send for it today! No obligation.

**NATIONAL SCHOOLS**

Pioneers of Technical Trade Training Since 1905  
 Los Angeles 37, California

Mail to: PUBLIC RELATIONS DIRECTOR  
 National Schools—Figueroa at Santa Barbara  
 Los Angeles 37, California  
 Please send me "Report to Industry"

Name: \_\_\_\_\_  
 Firm: \_\_\_\_\_  
 Address: \_\_\_\_\_  
 City \_\_\_\_\_ Zone \_\_\_\_\_ State \_\_\_\_\_

N-17



**CIRCUIT PAGE**

(FOR PARTS LISTS SEE PAGE 68)

**RADIO NEWS, JANUARY, 1947**

**FARNSWORTH MODELS EC-260, EK-262, EK-263, EK-264, EK-265**

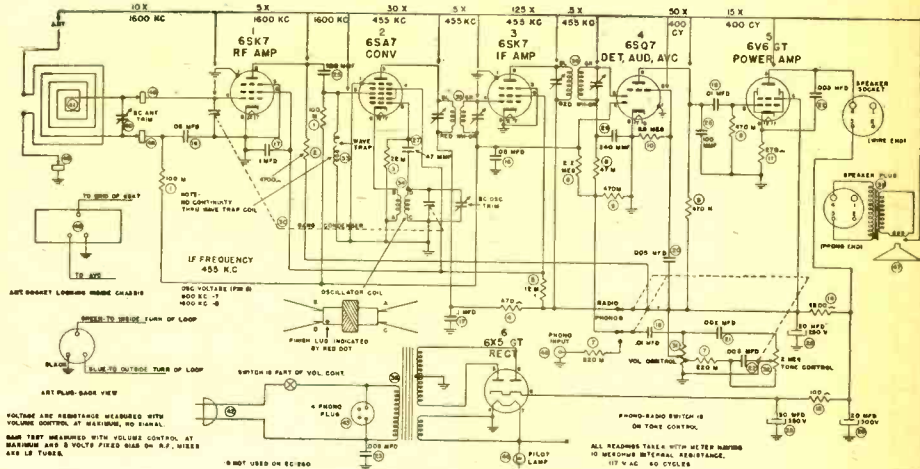

**RADIO NEWS, JANUARY, 1947**

**DETROLA MODELS 571A, 571B**

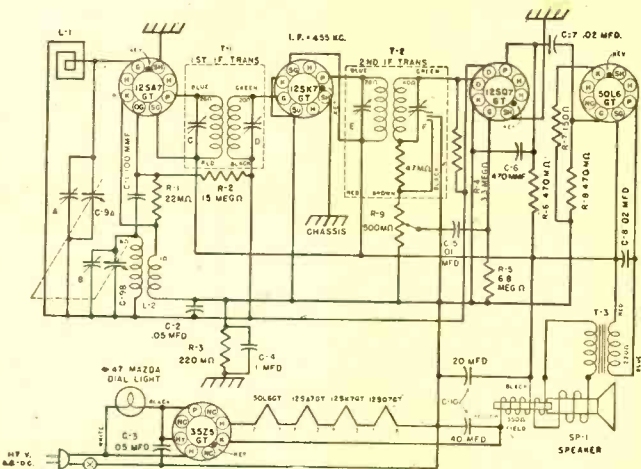

**RADIO NEWS, JANUARY, 1947**

**GENERAL ELECTRIC MODEL 250**

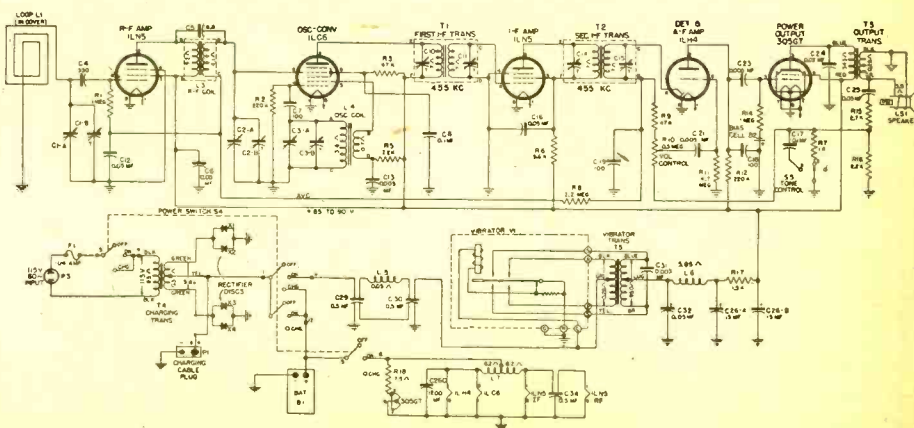





R-33  
1 uh

R-33  
10 uh

R-33  
750 uh

R-33 G  
750 uh

R-50 I  
10 mh

R-50  
1 mh

R-50  
2½ mh

R-60  
4 uh

## NEW CHOKES

The enlarged line of chokes now offered by National includes many new sizes and types and provides units suited to specialized as well as standard applications. Many popular new chokes are illustrated above, including the R-33G which is hermetically sealed in glass. Other models cover current ratings from 33 to 800 milliamperes in a variety of mountings carefully planned for your convenience. These as well as old favorites like the R-100 are listed in the latest National Catalogue.

**NATIONAL COMPANY, INC., MALDEN, MASS.**





# H/ RRISON HAS IT!—

## COMPACT POWER PACK

Good-bye  
to  
Battery  
Expense!  
for



- Portable Receivers
- Transmitters
- Walkie Talkies
- Remote Controls
- Test Equipment

This efficient pack works on any 6 Volt DC source, and has such desirable design features as neon voltage regulator, complete filtering, remote load start relay, etc. Brand new in sealed Navy inspected cartons, fully guaranteed. *One of the most sensational HSS values ever offered!*

Complete Vibrator Pack, less only battery (use it on four flashlight cells or your car battery, etc.)

**\$3.95**

For little more than the cost of one set of regular dry batteries, you can obtain a new, modern, vibrator pack that will save you space, weight, and money! Ruggedly made for Navy radio equipment, this pack gives excellent service under the roughest field conditions.

- Only 1 3/4" x 3 5/8" x 4" high (6 1/2" high with battery)!
- Weighs 3 lb. 10 oz., complete!
- Delivers: 135 volts at 20 ma. in continuous Military duty or 30 ma. or more, in intermittent Amateur service; 1.5 filament or 6.3 heater, bias, and microphone voltages.

Complete Power Pack including clip-in Willard storage battery. Unbreakable plastic **Non-Spill Case** (even if turned upside down!) Shipped bone-dry, fully charged, ready to put into immediate service, or to store for years. Can give several hours of continuous operation at full rated load and then be **Recharged** for only a few pennies by any 1/2 ampere charger or our special trickle charger. **\$5.50**

Spare Storage Battery **\$2.75**

**BATTERY CHARGER.** Noiseless. Selenium rectifier type, to trickle charge these or any other small batteries at .2 Ampere. 110 Volt AC. **\$2.97**

If recharging facilities are unavailable we can supply these packs with clip-in Willard 6 volt lead-zinc Primary batteries. 25 watt hour capacity. *Unlimited shelf life.* (Can store for years! Excellent for export.) 1 3/4" x 3 1/2" x 2 1/2". Only 21 ounces! Complete pack with TWO Primary batteries... **\$5.75**

**REPLACEMENT PRIMARY BATTERIES.** These batteries are also a fine source of 6 Volts DC for many other applications. Each... **95¢**  
Export packed case of twenty **\$14.75**

(Incidentally, the 21-mc. band is heard well in the Eastern U.S. mornings on several BBC frequencies now in use.)

The BBC is doing a splendid job in giving advance notice to its listeners with regard to the possibilities of increased sunspot activity, with recommendations as to the frequencies expected to be the more advantageous in a particular area during the disturbances.

### Nanking Assignments

According to a supplement to the Bern List, these call letters and frequencies have been assigned for the projected short-wave station at Nanking, China, to be operated by the Central Broadcasting Administration:

XGSA, 6.040; XGSB, 6.080; XGSC, 6.095; XGSD, 6.105; XGSE, 7.200; XGSF, 7.257; XGSG, 9.535; XGSH, 9.605; XGSI, 9.655; XGSJ, 9.675; XGSK, 11.725; XGSL, 11.735; XGSM, 11.800; XGSN, 11.880; XGSO, 15.105; XGSP, 15.135; XGSQ, 15.225; XGSR, 15.235; XGSS, 17.755; XGST, 17.785; XGSU, 17.835; XGSV, 17.845; XGSW, 21.450; XGSX, 21.510; XGSY, 21.550; and XGSZ, 21.620.

Most of these appear to be ex-Japanese frequencies. (Legge)

### Report From India

Those interested in "the other half of the world," will be especially concerned with these comments on reception in India, as just received from Anwer Lalljee, Bombay:

"During August, due to the monsoon, reception conditions were not too good, although the 16- and 13-meter bands were rather good, the latter being 'freakish' at times, in fact. Generally, reception on that band was best from about 6 a.m. to 12 noon, after which it deteriorated and faded out completely around 2 p.m. *Radio Australia* has been heard as early as 10:30 p.m. at R-3 and as late as 4:45 p.m. at R-6 and R-7; similarly, WLWS, Cincinnati, has been coming through regularly from 10 a.m. to 4 p.m. at R-7 to R-8, sometimes better. I have had similar experience with the BBC on this (13-meter) band, it is coming in R-7 to R-8."

Mr. Lalljee lists as *Best Bets* in his area, Radio SEAC, Colombo, Ceylon; BBC, London (Forces' Program and Eastern Service); Leopoldville, Belgian Congo; KRHO, Honolulu; AIR, Delhi (Home and External Services); CKNC, Montreal; WLWS, Cincinnati; PCJ, Hilversum, Holland; *Radio Brazzaville*, French Equatorial Africa; WGEO, Schenectady; *Radio Australia*; and WNRA, WNBI, New York City.

### RE 41-Meter Band

"The use for broadcasting of frequencies in the 7 megacycles-per-second (41-meter) band has been questioned in letters to the BBC by amateur radio experimenters in North and South America. They imply that, as this band was allotted exclusively to amateurs, broadcasters had no right to use frequencies within it.

(Continued on page 124)

**RADIO NEWS**

## ART-13 COLLINS AUTOTUNE TRANSMITTERS

Here's the most desirable transmitter for Amateur and Commercial service available in surplus today—the famous airborne ART-13!

Frequency meter type VFO—Adjustable fully automatic tuning with remote control provision—xtal controlled calibrator—813 final, modulated by 811's—2 to 18.1 Mc. (Adaptable to efficiently cover 10 meter band)—antenna tuning network and automatic relay—easily converted into a FB Ham Phone—CW transmitter with modern commercial features. See the complete articles in November CQ and December Radio News. Brand new, genuine **COLLINS**, in sealed containers. The latest improved production 47A. **\$124.50**

Less tubes and power supply.....

(With complete set of tubes \$144.50)

• **BC-406 15 TUBE UHF RECEIVER \$19.95**

(BC-406-A 16 Tubes, with motor—\$29.75)  
These are the good ones! Complete with tubes and conversion instructions. Ask the ham who got one from us! See our previous ads.

• **Telescoping Antenna \$1.95**  
Signal Corps AN29-C.

Sturdy, lightweight, brass antenna extends to 12 ft. 10 in., telescopes to 15 in. 3/4 in. diameter. Weighs only 30 oz. FB for mobile, or rotary beam elements..... Each

Six at \$1.74

### • KW Modulation Transformer

Here's an FB HSS value in a hard-to-get item! RCA commercial quality construction. Conservatively rated at 550 Watts of audio, will modulate up to a kilowatt final.

Primary matches any Class B modulators up to 10,000 ohm plate to plate. Impedance ratio 1:1. Secondary carries 450 ma. Tertiary winding to modulate screens or suppressors carries 80 ma.

Mycalex terminal board with three adjustable protective flash-over gaps insures against breakdowns. Open frame mounting. Actual wt. 38 1/4 lbs. 9 1/2" x 7 1/2" x 7 1/4" high. **\$24.75**

### • Antenna Tuning Unit

Signal Corps BC-939-A (Hallierafter AT-3)  
Will efficiently couple up to KW transmitter to any short or long wire antenna working against ground. Full range of 1.5 to 18 Mc.

You've seen these sold as surplus at \$79.50. Harrison sells them NOW, brand new, complete with RF meter, cabinet, and both plug-in vacuum condensers, for only **\$29.95**

### ★ ALL STANDARD LINES

We are Factory Authorized Distributors

for the top quality manufacturers and we now have in stock lots more new, latest improved production Ham gear! Visit our stores today, for everything you need. We promise you fresh clean material—quicker—at the lowest current prices—and above all, our sincere desire to be of friendly, helpful service.

**MAIL ORDERS?** Certainly! Just list everything you want (items in this ad, or any ad, magazine, or catalog) and include remittance.

Vy 73 de  
Bill Harrison, W2AVA

**HAM HEADQUARTERS**  
Since 1925!



**HARRISON RADIO CORPORATION**

10 WEST BROADWAY • NEW YORK CITY 7

PHONE—Barclay 7-9854 • EXPORT DEPT.—CABLE—"HARRISORAD"

JAMAICA BRANCH—172-31 Hillside Ave.—REpublic 9-4102



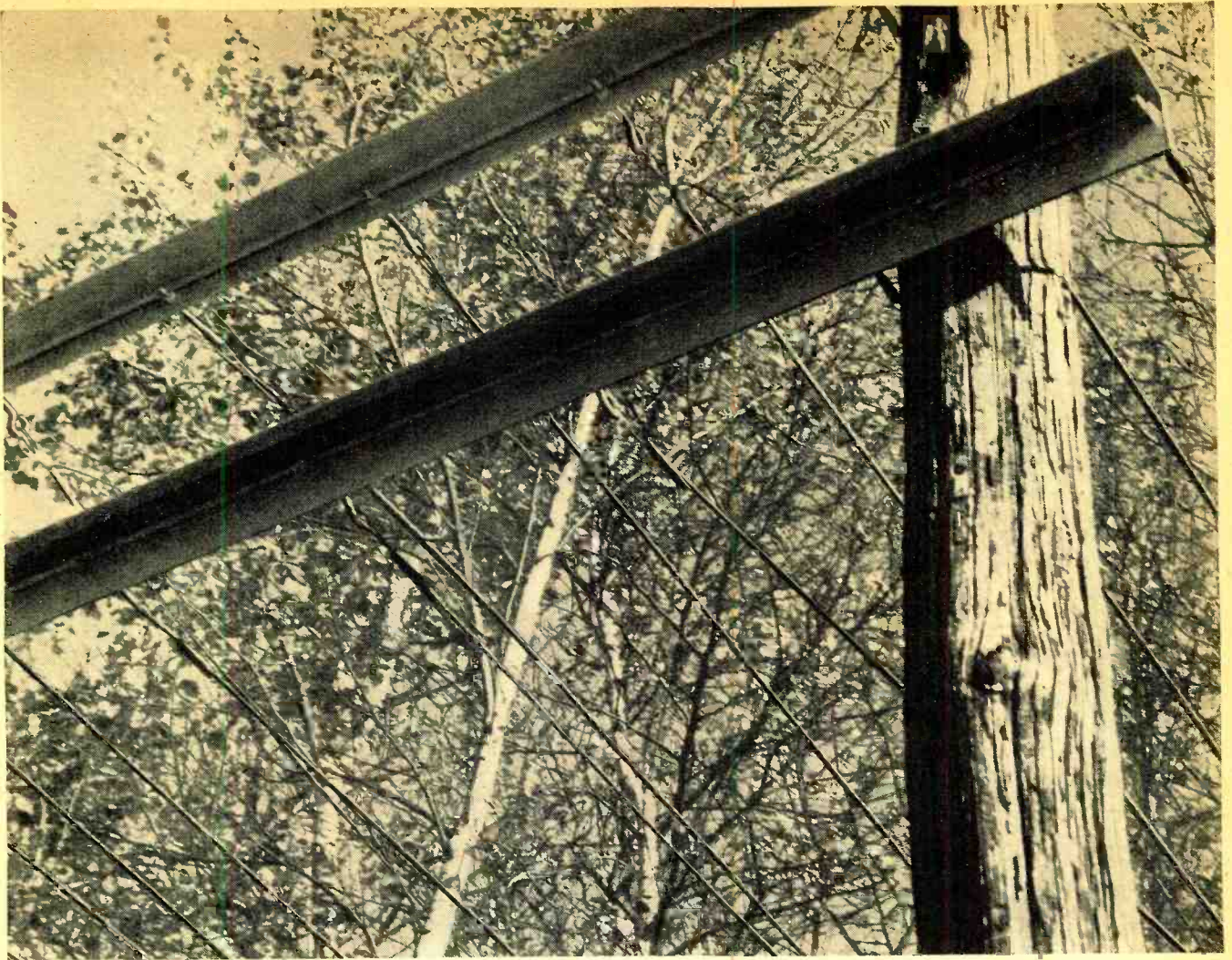

*Drop-wire undergoing abrasion tests in birch thicket "laboratory." Below, the new drop-wire, now being installed.*

## WE'RE GLAD THAT BIRCH TREES SWAY

The telephone wire which runs from the pole in the street to your house is your vital link with the Bell System. More than 17,000,000 such wires are in use.

The wire becomes coated with ice; it is ripped by gales, baked by sun, tugged at by small boys' kite strings. Yet Bell Laboratories research on every material that goes into a drop-wire—metals, rubbers, cottons, chemicals—keeps it strong, cheap, and ready to face all weathers.

Now a new drop-wire has been developed by the Laboratories which lasts even longer and will give even better service.

It has met many tests, over 6 or 7 years, in the laboratory and in field experiments. It has been strung through birch thickets—rubbed, winters and summers, against trees, and blown to and fro by winds. In such tests its tough cover lasts twice as long as that of previous wires.

House by house, country-wide, the new wire is going into use. Wire is only one of millions of parts in the Bell System. All are constantly under study by Bell Telephone Laboratories, the largest industrial laboratory in the world, to improve your telephone service.

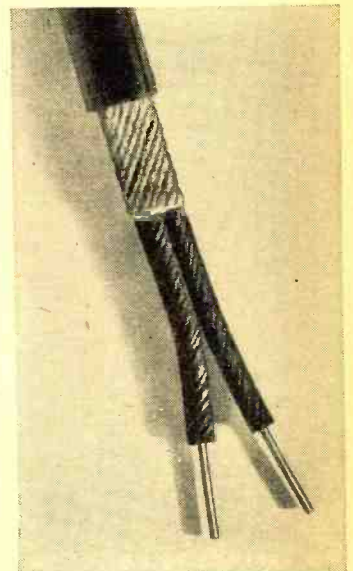

**BELL TELEPHONE LABORATORIES**



EXPLORING, INVENTING, DEVISING AND PERFECTING FOR CONTINUED IMPROVEMENTS AND ECONOMIES IN TELEPHONE SERVICE  
**January, 1947**



# RADIO PARTS

## ELECTRONIC EQUIPMENT

### MONEY SAVING VALUES



Concord has them! Radio & Electronic Parts, Supplies and Equipment of every kind, for every need... long-awaited, hard-to-get items... new merchandise, just received... Hundreds of bargains... in stock NOW for immediate shipment from CHICAGO or ATLANTA. Listed below are just a few of Concord's Money-Making Values in Top-Quality, Standard-Make Parts and Equipment. CHECK these offerings now - or write us your needs.

**IMMEDIATE SHIPMENT**



#### ALNICO V 5 P. M. SPEAKER

New Alnico V magnet provides maximum performance with minimum weight. Normal wattage 3, peak wattage 4 1/2. V.C. impedance 3.2 ohms. depth 2 7/16". **\$1.98** SB7009



**WELLS-GARDNER BC-348-N Communications Receiver**, 6 Bands—200-500 KC. and 115 MC. to 18 MC. in 5 Bands. 2 stages RF, 3 stages IF. Beat Frequency Oscillator, Crystal IF, Filter, Manual or Automatic A.V.C. Complete with tubes and 24 V.D.C. input dynamotor power supply, but supplied with complete instructions and diagrams for converting to 110 V.A.C. 60 cycle operation. **BC-348-N \$53.95**

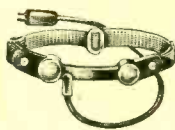

#### CARBON THROAT MICROPHONE

Will work into any 200 ohm impedance input circuit. Has adjustable strap to fit any neck. Ideal for ultra high frequency mobile work for hams. Supplied with strap, 10' cord and plug. **SB7060 \$49**



#### 3 Mfd. 4000 Volt Hi-Voltage Condenser

Large 3 mfd., 4000 v. DC. condenser, hermetically sealed in an aluminum can. Size 4 1/2 x 3 11/16 x 7 1/2" high. **\$4.95** SB3168



#### Supreme Model 543B 1000 O.P.V. A Sensitive Meter

Has pin jack terminals, and includes the following ranges:— 0/6/60/600 D.C. M.A., 0/15/150/600/3000 V. A.C. and D.C., 0/2000/200,000 ohms. This meter is convenient to carry. Weighs 28 ozs. Uses full size 3" meter with a rugged, accurate I.M.A. movement. All resistance ranges are operated by batteries furnished with the unit. Bakelite case. Size: 5 7/8 x 2 1/16 x 2 1/8". Shpg. wt. 2 lbs. **\$18.57** C21745



#### D.C. MILLIAMMETERS

2 1/2" flange mounting type. Black dull finish bakelite case. Mtr. Hdwe. included — Large, clearly legible dial calibrations. Either **5B4122-0-20 M.A.D.C.** or **5B4116-0-300 M.A.D.C.** Special... **\$3.23**

### SAVE ON VALUES LIKE THESE

**A POPULAR HAM TUBE AT A REAL LOW PRICE**  
**9003 VHF Midget Super Control RF 95¢**  
Pentode Tube

**HEAVY DUTY LINE FILTER**  
Solar Elim.-O-Stat. Completely shielded. Type EN106. **SB3218 Each \$1.79**

#### CRESCENT AUTOMATIC RECORD CHANGER

Simple, single control, plays ten 12" or twelve 10" records automatically. Rejects any record desired, or permits optional playing of records manually. Only three moving parts while changing. Fast... changes records in 5 seconds. Has self-starting, 78 R.P.M., 110 volt 60 cycle AC, heavy duty motor. Finished in two-tone brown with attractive plastic trim. Requires only 5 1/4" head room and fits any cabinet with 12 1/2" x 16 1/2" changer area. **C22503. SPECIAL \$19.95**

**TUNER UNIT TU-10-B.** Continuous frequency range from 10 MC. to 12.5 MC. VFO oscillator tuning section, buffer, coupling, capacitors and choke, and buffer output matching tapped coil and condenser. Size 16 1/2" lg. x 7 3/4" h. x 5 1/2" deep. **AS4132. SPECIAL \$2.95**

**NEUTRALIZING TOOL KIT**  
12 tools Telescopes into 5 units  
Composed of alligator side metal nib — 6" insulated driver — metal nib, 5/16" and 1/4" nut wrench, 1/4" ins. square nut wrench, 1/4" hex metal side wrench, 2 1/2" ins. driver with metal nib, 1/2" hex slotted insulated wrench driver, 5/16" hex ins. nut wrench, 5" and 6" ins. **\$2.49** driver. **5B6547**

**WIRE STRIPPER**  
Strips wire instantly! Fastens to bench or other support. Wire stripped to any length. Strips wire up to 12MM diam. Each **98¢** **C15268**

**AERIAL WIRE**  
Contains 7 strands—4 copper—3 of monel. 100 foot coils. **5B5133 Each 29¢**

**T-17-B 200 Ohm Carbon Mike.** Lightweight, with press-to-talk button. Built-in filter to suppress carbon hiss. 5" rubber covered cable and **\$2.49** PL-68 3-circuit plug supplied. **SB7062**

**Midget Volume Control** — 1 Meg. ohm Standard 3/8" Bushing, 1/4" dia Shaft, 3/2" long, with split spline for push-on knob. **CB154 \$35**

**STANCOR Universal Output Transformer Type A3856.** Primary for all single or push-pull plates. Secondary adjustable from 1 to 30 ohms. Two-inch mounting centers. 4 watts at 35 mils. **\$1.32** **C1675. SPECIAL**

**Mail the Coupon Below Now!**  
For New Concord Bulletin of Radio Parts and Electronic Equipment. See 8 giant-size pages packed with Radio Needs — Condensers, Meters, Controls, Transformers, Switches, Relays, Tools, Amplifiers, Records, Players and Changers — new and scarce items — scores of bargains. MAIL COUPON NOW!

**CONCORD**  
**RADIO CORPORATION**  
LAFAYETTE RADIO CORPORATION  
CHICAGO 7 ATLANTA 3  
901 W. Jackson Blvd. 265 Peachtree Street

Concord Radio Corporation  
901 W. Jackson Boulevard, Dept. E-17  
Chicago 7, Illinois  
Please rush my FREE COPY of the new Concord Bulletin of Radio Parts.

Name \_\_\_\_\_  
Address \_\_\_\_\_  
City \_\_\_\_\_ State \_\_\_\_\_

ception. The present sunspot cycle, in fact—judging by the course of events since its minimum in April, 1944—promises either to give rise to solar activity of exceptional magnitude, or else to reach its maximum in an unusually short time. Already, only two years or so after the minimum, the activity has reached levels comparable to those of about four years before it, and this rapid increase shows no sign of abatement." (This statement was made prior to the increased sunspot activity experienced widely during September, particularly during the latter half of that month.)

The BBC engineer continued, "Concurrent with the increase in solar activity, and owing, of course, to its effects, there has been a rapid increase in the electrification or 'ionization' of the upper atmosphere. And as it is the degree of ionization of this region—the 'ionosphere'—that determines the frequencies suitable for short-wave communication at any particular time of day, this increase of ionization must be taken careful account of when selecting the frequencies to be used.

"During the northern hemisphere summer months, however, there is a seasonal effect in the ionization which, so far as the daylight hours are concerned, counteracts that caused by the solar cycle. As the autumn equinox approaches, this seasonal effect will cease to act against the solar cycle effect, and the full increase in the ionization will become apparent. In short—in September of 1946 listeners to the BBC may expect some extensive changes in the frequencies they receive best.

"When the ionization is high, the highest frequencies (shortest wavelengths) become of the greatest utility; when it is low the reverse applies. So, from September onwards the tendency will be to make greater use of the higher frequencies for transmission over daylight paths, and this situation will probably hold good throughout the northern winter. So far as the night-time frequencies are concerned, these will probably decrease somewhat from September towards the midwinter period, but even so they will often be considerably higher (wavelengths will be shorter) than those that were in use during the same months of last year. All of these measures are not only desirable, of course, but really necessary if the most efficient broadcasting service is to be provided.

"The increased ionization will make desirable the use for service to certain countries of a frequency or wavelength band not hitherto employed for the purpose—namely, the 28 mcs. (11 meter) broadcasting band. It is more than probable that this band will be suitable for service (of the BBC) to India and the Far East and to South and Central America, as well as continuing to be of service to Africa. It may well be heard in other countries, too, and its use may be found advantageous at some time during the winter for service to North America."



AT LAST!

# THE BASIC KIT-

YOU'VE ALWAYS WANTED!

- ALL-METAL CABINET
- HANG ON WALL—SET ON SERVICE BENCH
- INDIVIDUAL, IDENTIFIED COMPARTMENTS
- ATTRACTIVE YELLOW, BLUE AND SILVER FINISH
- FACTORY PACKED

NEW **IRC** RESISTOR KIT  
 CONTAINS COMPLETE VARIETY OF STOCK  
 NEEDED FOR YOUR DAY TO DAY WORK!



## Basic Kit Contents

- 160 IRC Type BTS New, 1/2 watt metallized filament Resistors
- 115 IRC Type BTA New, 1 watt metallized filament Resistors
- 35 IRC Type BT-2 2 watt—metallized filament Resistors
- 60 IRC Type BW-1/2 1/2 watt—wire-wound Resistors
- 20 IRC Type BW-1 1 watt—wire-wound Resistors
- 20 IRC Type BW-2 2 watt—wire-wound Resistors
- 22 IRC Type AB 10 watt Power wire-wound Resistors
- 16 IRC Type ABA 10 watt Power wire-wound adjustable Resistors
- 6 IRC Type EPA 50 watt Power wire-wound adjustable Resistors
- 7 IRC Type ESA 80 watt Power wire-wound adjustable Resistors
- 6 IRC Type X-3 Bands—additional bands for adjustable Resistors
- 2 IRC Type MW-2J Bleeder-type Resistors
- 2 IRC Type M-1034 Bleeder-type Resistors

Free! Neat, Handy, All-Metal Cabinet free with Basic Kit of resistors ordered at standard resistor prices. Cabinet is not sold separately.



• YOU ASKED US FOR IT! HERE IT IS! THE IRC BASIC KIT—a wide-variety stock of most-needed resistor sizes and types that equips you to do just about any job you'll encounter in your day to day work. This unusually handy and convenient assortment of items was carefully selected through an exhaustive study of orders and a survey of IRC distributors and dealers.

The IRC Basic Kit is a practical planned time-saver, particularly suited to the needs of servicemen, schools, colleges, research labs and Industrial Maintenance Departments. The Resistor Assortments are so arranged that in most cases even a shortage of stock in any *one* range may be compensated for by using two other ranges in series or parallel. The power wire wound resistors included are useful in replacing many power resistors used in old-time receivers and as ballast resistors in some of the more modern AC-DC receivers. Additional adjustable bands are included in the Kit for use in making up bleeder sections.



## INTERNATIONAL RESISTANCE CO.

401 N. BROAD ST., PHILADELPHIA 8, PA.

In Canada: International Resistance Co., Ltd.; Toronto, Licensee





# International SHORT-WAVE

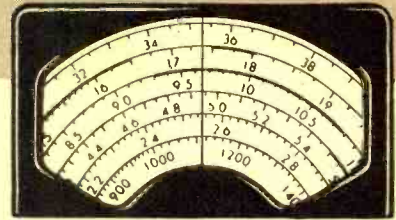

Compiled by **KENNETH R. BOORD**

**S**HORT-WAVE enthusiasts the world around can look forward to 1947 with few misgivings. I believe they can face the New Year with hope of better reception to come.

Short-wave radio is rapidly coming of age. The results of wartime research and invention should be more evident in both broadcasting and receiving equipment in the years immediately ahead. Too, we can expect expanded facilities and schedules as well as better programming. Many new stations—from New Zealand to Northern Europe to Central Africa and back to Java—will, in all probability, take to the airwaves this year.

Broadcasting experiences during World War II have clearly demonstrated the effectiveness of short-wave radio and that it should prove an ideal medium in helping to achieve and maintain better understanding between the nations of the world. *In no other way can the spoken word reach so many people in so short a time.* In no other way can one tell one's story so quickly either to or from the more remote places on the globe. I, for one, feel strongly that international short-wave radio will assume its rightful place and responsibility in the era just beginning.

Since war's end there have been many complaints regarding the poor

quality of receivers in general—and of the component parts thereof, including tubes, in particular—but as production increases and demand tends to lessen, in all likelihood, manufacturers will put more stress on "quality" as well as "quantity" production.

Last, but not least, scientists predict that during a part of 1947 we should have some respite, perhaps brief, however, from sunspot activity that was so annoying to short-wave listeners during the past year.

All in all, we can anticipate brighter listening days (and nights!) ahead for us all.

\* \* \*

### Uruguay's CXA19

Through the courtesy of John Znaidukas, Philadelphia, this month we present information regarding short-wave station CXA19, located in Montevideo, Uruguay, South America:

CXA19 operates with a power of 5000 watts, is listed on 11.835, but in a letter to Mr. Znaidukas, an official of the station indicated the current frequency as 11.705. "El Espectador," as the station is known, has been experiencing quite a bit of interference lately and has been sending out requests for information on said interference, in order that data may be submitted to the Government of Uru-

guay in the hope of receiving a new allocation of frequency.

Schedule is 6 a.m. to around 10:05 p.m. sign-off *daily*. Apparently, all transmissions are in Spanish.

This station uses a full-wave horizontal antenna, beamed to the United States and to Europe; the transmitter was made locally, having been designed by the technical staff of CXA19 and then was constructed in the station's own workshop. The transmitter was assembled as two units—one-kilowatt plate modulated exciter and a five-kilowatt radio frequency linear amplifier, which is equipped with two Marconi CAT-9 tubes.

Mr. Znaidukas received his verification and some photographs from CXA19 two months after mailing in his reception report. The letter was signed by Sr. Jorge Cobilo, el Gerente General. Address is "El Espectador," Difusoras del Uruguay, La Cadena Uruguaya de Radiodifusion, 1393, La Sociedad Anonima, Montevideo, Uruguay.

*In reporting to this station, it is suggested that full information be furnished regarding any interference noted.*

\* \* \*

### Sunspots to Continue

According to Dr. John Q. Stewart, Princeton University astronomer, sunspots, some of them as big as the earth, will continue to disrupt radio, wireless, and telegraph facilities for at least another year. Even then the world will get only a comparatively brief respite from this solar phenomenon. One spot cycle is just completed and then another one starts. It usually takes about 11 years for the maximum to be reached.

Dr. Stewart, professor of astronomical physics, and George S. Baldwin, Jr., a Princeton undergraduate, recently devised a formula on which they based the prediction that the present cycle of sunspots would reach its maximum by about the end of 1947. (Havlena)

Of interest to ISW listeners will be this comment by a BBC engineer in a recent issue of "London Calling":

"Sunspot activity continues to increase very rapidly, and the effect of this upon the ionosphere seems likely soon to have definite repercussions upon short-wave transmission and re-

Unless otherwise indicated, all time herein is in Eastern Standard Time, 5 hours behind GMT.

View of power amplifier, showing the two Marconi CAT-9 tubes and line plate circuit, at station CXA19, Montevideo, Uruguay, South America. The station is currently operating on 11.705, 6 a.m.-10:05 p.m. EST.

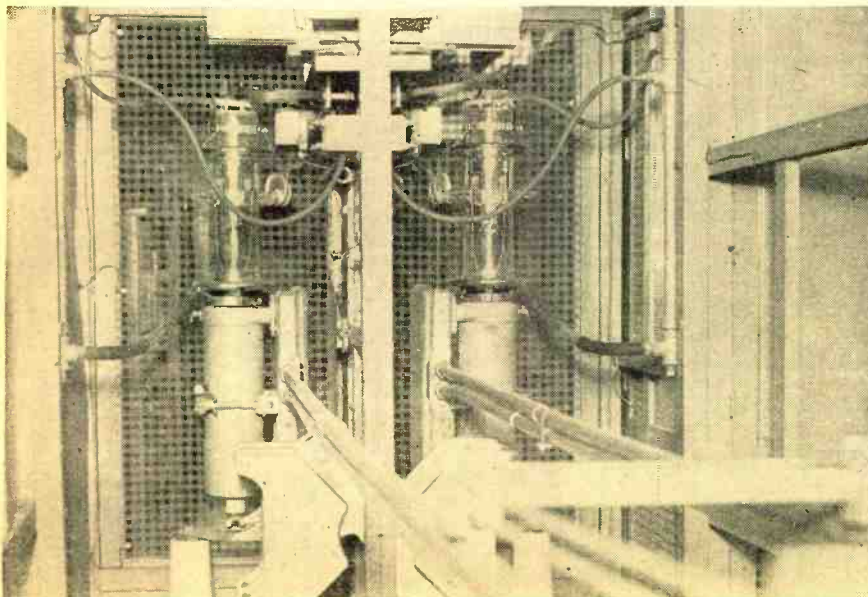



with a slight nonlinearity. When a 0 to 1 milliammeter is used the departure from linearity is serious enough to require the scale to be hand calibrated. This is not as difficult as it sounds. All the equipment that is needed for such a calibration is two flashlight cells and one 45 v. "B" battery. With these voltage sources, and a few resistors of known value, all the scales can be calibrated. The non-linearity will be precisely the same for all ranges, so only one range must be calibrated as the others may then be drawn in.

It is suggested that the 10 v. scale be chosen for the calibration and then 6 flashlight cells connected in series will give sufficient points to construct the scale, i.e. 1.5 v., 3 v., 4.5 v., 6 v., 7.5 v., 9 v. (actual voltage of a new cell is somewhat higher than 1.5 v., on the order of 1.55 v.).

If the more sensitive meters are used, the scale can be constructed directly with a compass. The author constructed his scale on a piece of 8" x 10" paper. This enlarged scale was then photographed and a print made from the resulting negative which was precisely the right size to fit the 3" meter used in the model. This photographic reduction minimizes the imperfections in the drawn original and results in a scale which looks as if it had been printed. A box camera may be pressed into use in lieu of a focusable model, and a +3 portrait attachment used in front of the lens. The picture can be made from a distance of about two feet which will result in a very acceptable scale. Of course, the scale may be drawn directly on a piece of paper or cardboard and glued directly over the existing meter scale, or a meter may be purchased with the scales on it. The reproduction (Fig. 5) of a scale for a 3" meter may be traced or cut out and pasted on the meter face.

The ranges chosen by the author are 0 to 10 v., 0 to 50 v., 0 to 100 v., 0 to 500 v., 0 to 1000 v. Any number of intermediate values can be used by providing the proper taps on the

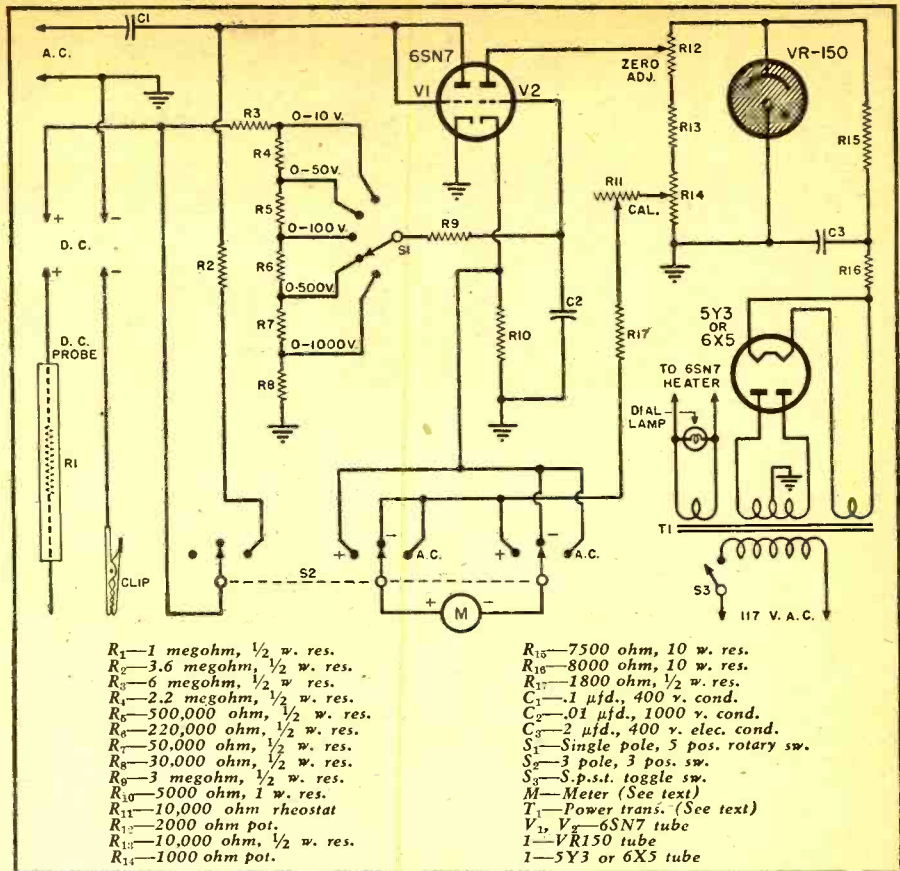

Fig. 2. Circuit diagram of v.t.v.m. The a.c. input impedance is 6.3 megohms while the d.c. input impedance is rated at 10 megohms.

voltage divider. It is not recommended that the 1000 v. a.c. scale be used, as 1000 v. is too high a voltage to apply to the 6SN7 diode connected rectifier.

The resistors in the divider should be as accurate as possible. If you can obtain 1% precision resistors, they should be used; if not, 5% metalized 1-watt resistors will do. If greater accuracy than 5% is desired, the values may be obtained by a series or parallel connection of two or more resistors to make up each of the six resistors in the divider. If an accurate

ohmmeter is available, the resistors may be pruned after the instrument is built, by applying known voltages and adjusting the resistor until the scale reads properly. The calibration pot should be set on the 10 v. scale so that a known voltage of 3 volts reads 3 v. on the 10 v. scale. After each change in the divider, the 10 v. scale should be checked to be sure its calibration has not been affected. If it has, readjustment of the calibration pot is necessary. The zero adjusting pot which is located on the front

(Continued on page 84)

Fig. 3. Under chassis view of completed test instrument.

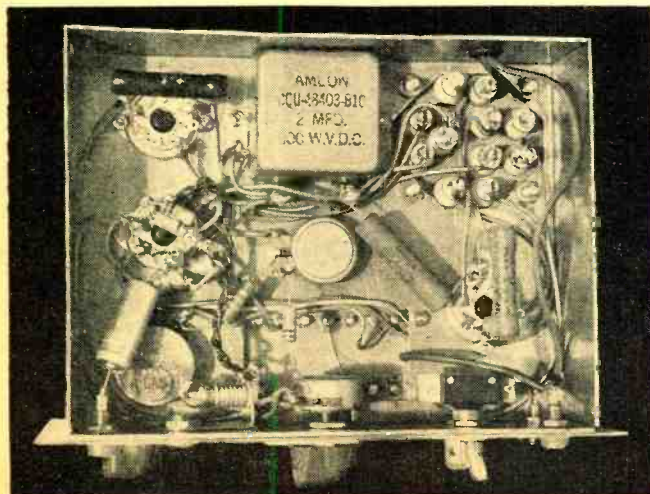
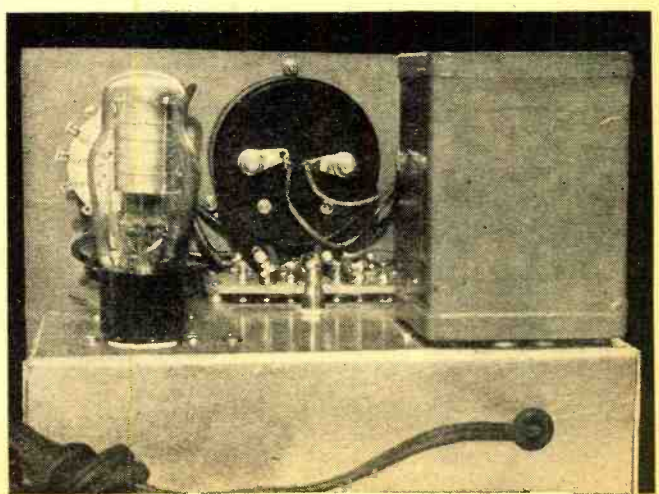

Fig. 4. Rear view shows neatness of above chassis layout.





# Home Constructed V.T.V.M.

By  
**J. H. CARLISLE**

**T**HERE have been published in all leading magazines, from time to time, vacuum tube voltmeters of every size, shape and description. We propose to describe a simple vacuum tube voltmeter which requires essentially, one tube, exclusive of the power supply rectifier, and in which the builder may use anything from a 0 to 50 microammeter to a 0 to 1 milliammeter.

In the model described, a VR150 tube is included in the interest of greater stability. This, however, is a refinement which is not essential to its operation. The circuit is shown in Fig. 2, and consists of a bridge with a tube as one arm. The tube is operated practically as a cathode follower and is highly degenerative. This high order of degeneration is instrumental in providing the great stability of the circuit. If you wish to look at the circuit another way, it consists of a cathode follower and the voltage is read across its cathode by means of a meter whose other side is connected to the proper voltage to buck out the initial reading on the meter caused by the no signal current in the tube and thus allows the needle to be set to zero.

One of the greatest advantages of using the cathode follower is the fact that it loads a circuit under test very slightly. There are two causes of loading when a tube's grid is connected to a circuit—capacity and grid current. In a cathode follower, the input capacity is degenerated to a value approximately equal to the measured input capacity of the tube, instead of being equal to the input capacity of the tube times  $\mu$ , as it would be in the conventional circuit with the load in the plate circuit of the tube. Grid current can be prevented by inserting sufficient series resistance in the grid circuit to keep any current drawn by the grid very low, in the order of a fraction of a microampere. This is the function of the 3 megohm resistor  $R_2$  in Fig. 2.

The main objective in a vacuum

tube voltmeter is to provide a voltmeter which loads the voltage to be investigated as slightly as possible, i.e. it draws as low a current from the investigated source as is feasible. There is a limit, however, to the value of resistors which are readily available to the average service man or experimenter, so we have set 10 megohms as the total input resistance for the instrument (the effective a.c. impedance is 6.3 megohms). This gives a one-million-ohms-per-volt instrument on the 10 volt scale which means for full scale deflection on a 10 volt scale it will draw one microampere.

On the 50 v. scale it draws 5 microamperes. These currents may not be considered appreciable for any measurements encountered in service work or general experimenting.

The 6SN7 has been chosen as an appropriate tube for our circuit, first because it contains two complete triode sections; second, because it is easily obtainable; third, because its plate characteristics are nearly straight lines. The first section of the 6SN7,  $V_1$ , is connected as a diode to act as a rectifier so that the meter can be made to read a.c. voltages. It is highly desirable in order to reduce confusion, to have the voltmeter read either a.c. or d.c. on the same scale, so the diode is connected, as shown in Fig. 2, to read a peak value of a.c. voltage and then a resistor is inserted

to act as a voltage divider with the 10 megohm divider on the a.c. voltmeter circuit. In this way the meter will read the r.m.s. value instead of peak. This is also the reason a scale of lower than 0 to 10 volts was not included, as the diode imparts a serious enough nonlinearity to require a separate scale for any a.c. scale lower than 0 to 10. The layout and construction are apparent from the photographs (Figs. 1, 3, and 4).

The VR150 tube holds the plate voltage on  $V_2$  constant with line voltage changes, although, due to its high order of degeneration,  $V_2$  plate current does not change more than a few per-cent with a considerable change in plate voltage. It is suggested that if the VR150 is not used, it should be replaced with a 10 watt resistor of such value as to provide 150 volts on the plate of  $V_2$ .

The author used a 0 to 50 microammeter as the indicating device on his model. However, it was found that a 0 to 100 or 0 to 200 microammeter could be used while maintaining the extremely good linearity. The instrument, as shown with 50 microampere meter, was so linear that a scale was drawn and divided with a compass. When checked with known voltages, there was no departure from linearity greater than the width of a line forming the divisions on the scale.

A 0 to 0.5 milliammeter can be used

Fig. 1. Front panel view of completed test instrument. The meter can have a movement anywhere from 50 microamperes to 1 milliampere.

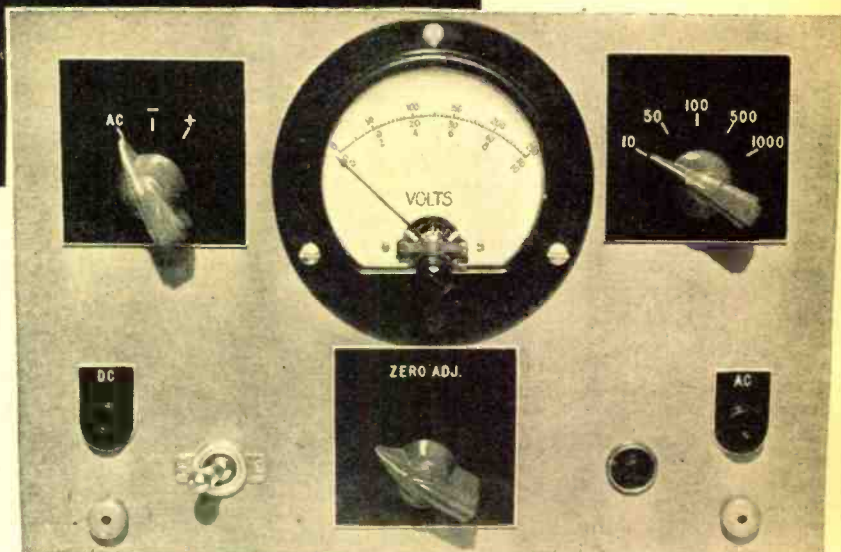

*Design and construction of an extremely simple vacuum tube voltmeter. It can be built by the novice with a small cash outlay.*





Fig. 3. Field-strength meter built by WIAWD. The indicating meter is a 1-inch 0-200 d.c. microammeter and the detector is a Sylvania 1N34 crystal diode. The removable brass rods extending from each side of the instrument form a doublet antenna for signal pickup. Excellent operation is obtained on all bands and the instrument has been used for antenna adjustment, neutralizing adjustments, transmitter tuning across the room, modulation monitoring, and stray r.f. detection. The crystal diode may be seen connected to two small brass blocks which have been threaded to admit the dipole antenna rods. One rod has been unscrewed to show ease with which antenna may be removed.

Ranges provided are 0-1, 0-10, 0-100, and 0-1000 volts d.c. and 0-1 milliamperes d.c. Individual builders may provide other ranges and may include a.c. voltages and additional milliamperes ranges as well.

The instrument panel, as shown in the photographs, is  $\frac{1}{16}$ -inch-thick wire-brushed aluminum  $2\frac{7}{8}$ " high and  $1\frac{1}{16}$ " wide. The mounting box is  $\frac{7}{8}$  inch deep. This voltmeter is in the featherweight class.

Multiplier resistors (See Fig. 2) are small-sized 1-watt carbon units, hand-picked for exact resistance values. The free-point contact terminals are standard sized, insulated banana jacks which accommodate the banana plugs on standard meter test leads.

The instrument size could have been reduced still further if smaller contact jacks had been obtainable. Also, a subminiature rotary switch would have permitted internal switching of the meter ranges. These are needed components which undoubtedly will be manufactured when widespread use of the small meters justify their production.

The test meter, taking up not quite as much room as the package of cigarettes alongside which it is shown in Fig. 1, fits into the serviceman's pocket with equal ease.

Figs. 3 and 4 show a universal field strength meter, using an MB Model 100, 0-200 d.c. microammeter, having an internal resistance of approximately 510 ohms. This instrument, built by A. R. Pierce, Jr., WIAWD, has been used already for adjusting beam antenna elements, neutralizing transmitters, watching for carrier shift in a 'phone transmitter, detecting stray r.f. energy in the shack and on power lines, and checking polarization of transmitted signals in the neighborhood of the transmitter.

As will be seen from Fig. 4, the in-

strument consists of a detector and indicator connected to the center of a small doublet antenna. The aperiodic detector is a Sylvania 1N34 crystal diode. The antenna is a rigid dipole composed of two 24-inch lengths of  $\frac{3}{16}$ -inch-diameter brass rod. Although the antenna appears to be a half-wave at 233.7 megacycles, the field strength meter has been employed successfully at wavelengths as high as 80 meters. Either or both antenna rods may be removed by unscrewing from a small brass mounting block on the instrument panel.

The entire instrument, with its pickup antenna, may be rotated easily in any plane when waves of various polarizations are encountered. In a recent test, as the operator walked by a large nearby metal body while reading the field strength meter, rotation of the antenna from vertical to horizontal meant the difference between no indication at all and better than full-scale deflection of the microammeter.

In certain applications involving close proximity of the field strength

Fig. 4. Circuit diagram of the field-strength meter shown in Fig. 3. The brass antenna rods are  $\frac{3}{16}$  inch in diameter and 24 inches in length.

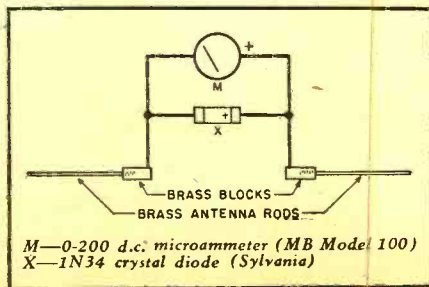

meter and transmitter, as when watching for carrier shift on a radio-telephone signal with the transmitter across the room, the dipole antenna will pick up excessive r.f. energy and the meter pointer will be driven vigorously against the pin. Pickup may be reduced in such a case by unscrewing and removing one of the antenna rods, as shown in Fig. 3.

If an individual builder desires, he may include in the midget field strength meter a tuning circuit, comprised of a midget variable capacitor and miniature plug-in coils. Tuning capacitors now are available in very small over-all sizes, and plug-in coils may be wound on tiny forms. Fig. 5 is a suggested circuit diagram for a tunable instrument.

If the dial of the tuning capacitor is graduated in megacycles, the instrument will be invaluable as a direct-reading absorption wavemeter, as well as a field strength meter, modulation checker, and neutralizing indicator.

### On the Way

With sub-miniature batteries and tubes now available, the possibilities offered by the new miniature microammeters for construction of a single-packaged pocket v.t. voltmeter are not easily ignored. The author now is at work on such an electronic voltmeter. There is every indication that the developmental work soon will be completed, and it is planned to describe the instrument in this magazine.

—30—

Fig. 5. Suggested circuit for a tuned field-strength meter.

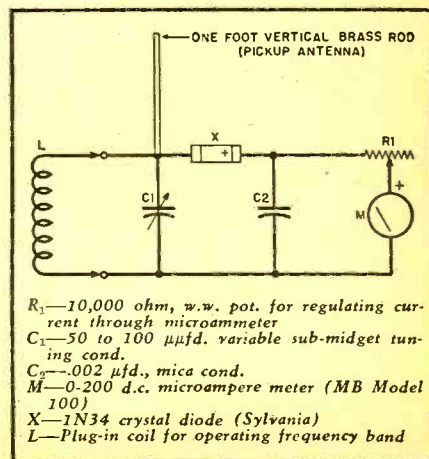



# Putting the new SMALL METER to work

By  
**RUFUS P. TURNER, W1AY**  
Consulting Eng., RADIO NEWS

**These meters make possible, for the first time, real pocket test instruments and complete sub-miniature radio transmitters.**

**I**N comparatively recent months, an Eastern instrument manufacturer<sup>1</sup> has made available to the public an interesting line of miniature panel-mounting meters developed during the war. Of the movable coil type, these instruments, in the round case style, are only 1 inch in diameter (the same size as that of a man's round-face wrist watch) and are available in all standard d.c. ranges from 0-100 microamperes to 0-10 milliamperes. Rectifier-type a.c. instruments are available in 1½-inch cases. Although the meter scales are small,



Fig. 1. Front and rear views of vest-pocket multi-range d.c. voltmeter, using a 1-inch 0-1 d.c. milliammeter. Ranges provided are 0-1, 0-10, 0-100, and 0-1000 d.c. volts and 0-1 d.c. milliamperes. Circuit schematic is given in Fig. 2. Size of the complete instrument is 2⅞" by 1-11/16" and ⅞" deep.

they are perfectly readable without magnification.

These meters are fast and rugged and excellently damped, despite their small size, and are sealed against dust and moisture. Provided with powerful Alnico No. 5 magnets, soft iron pole pieces, and steel pivots in sapphire bearings, they conform to AWS specifications. The accuracy of all scale points is plus or minus 2% of full-scale deflection.

The new sub-miniature meters are of particular interest to radio amateurs, experimenters, and servicemen who plan to build pocket-size test instruments and midget communications gear. Heretofore, it has been possible to build equipment much smaller in size than available meters. In fact, a well-known paradox has been the "vest-pocket" transmitters and field strength meters that were as big as the then smallest available milliammeters. There really was little point in reducing dimensions of the instruments so drastically when provision had to be made for a space-hogging meter.

Sub-miniature test instruments and radio gear are more than mere curiosities. A reliable vest-pocket test

meter is a distinct asset to the stairs-climbing serviceman already bogged down with a tool kit and other heavy paraphernalia. And the traveling radio ham has strong praise for a practical camera-sized transmitter or transceiver, complete with tuning meter, which will not noticeably increase his baggage burden as he approaches some distant hotel. Likewise, the ham at home appreciates the opportunity of keeping his monitors, frequency meters, and field strength meters small—for easy portability and minimum storage space.

## Applications

It would not be practical in a single article to give examples of all amateur and service applications of the new miniature meters. Only two applications actually are illustrated here, but these should arouse interest and stimulate further developmental work in this direction.

Radio service applications might include pocket voltmeters, milliammeters, ohmmeters, and multimeters, v.t. voltmeters, wattmeters, impedance meters, null indicators for bridges, decibel meters, continuity testers, first-step tube testers, microfarad meters, inductance checkers, battery checkers, and the like.

Amateur radio applications might include field strength meters, radio-phone monitors, per-cent modulation meters, external or internal S-meters or tuning indicators for receivers, neutralizing indicators, volume level indicators, milliammeters on midget transmitter panels, indicating meters in absorption wavemeters—especially u.h.f., etc.

Figs. 1 and 2 show a real vest-pocket, multi-range d.c. voltmeter. The basis of this 1000 ohms-per-volt instrument is an MB Model 100, 0-1 d.c. milliammeter having an internal resistance of approximately 20 ohms.

Fig. 2. Circuit diagram of the test instrument illustrated in Fig. 1.

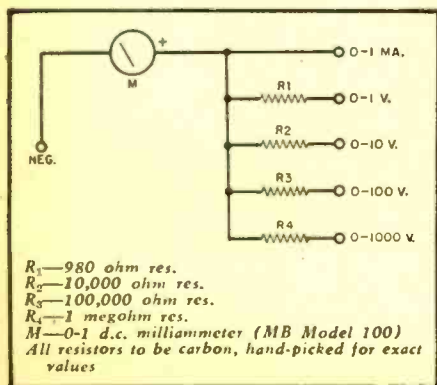

<sup>1</sup>The MB Manufacturing Co., Inc., 331 East St., New Haven 11, Conn.





Dealers are turning to complete demonstration of their merchandise. Improper use and knowledge of the appliance will cause "customer headaches."

A satisfied customer is the best advertisement a dealer can obtain. Remember however, that although the radio combination may be one of the best, poor installation will send your customer to your competitor.



# Be Sure of Quality BEFORE YOU SELL

By  
**M. KENNETH BRODY\***

***A dealer's reputation is always at stake.  
High-quality home performance of all  
products will assure satisfied customers.***

**A**S YOU read this, the first slow trickle of radios and appliances reaching your store is starting to increase to a stream. Soon the stream will widen to a river and soon after that we may expect flood tide. What will your position be when the flood is on us? If you use care and caution in building your dikes you will weather the flood and be strong. If you get careless and try just to ride the crest of the wave, you will be weak.

There are a few, and I feel a very few, dealers who have gone into the radio and appliance business with the fond hope of making a quick killing, taking the cream off the business, and then getting out. The words of advice and caution that follow are not for these. They are for the good, reliable dealers who have been in business for years and intend to remain in busi-

ness. They are also for the veteran and many other reliable persons who have set up a radio and appliance business with the thought of continuing in business by being an asset to the community.

Let us first see what makes a good radio and appliance dealer. I think the following are the two most important factors, although there are many others:

1. A Good Product
2. Good Service

This brings us to the point of "What is a good product?" In my thoughts a good product is, "A piece of merchandise that, for the lowest possible price, will do, in the best possible manner, the job for which it is intended."

\* Former Technical Director, McCall's Test Rooms, McCall's Magazine. Chairman, Committee of Domestic and Commercial Applications, American Institute of Electrical Engineers.

It must require a minimum of attention and service. When service is necessary, it must be easy to work on and the manufacturer or jobber must have adequate parts stocks available.

"Good Service" is much more than repairing a defective product when it needs repairing. "Good Service" starts before the customer enters your store and extends the life of the product you sell to him. "Good Service" gets your customer; "Good Service" keeps him sold; "Good Service" makes him a repeat customer and "Good Service" makes customers out of his friends.

As I said before, "Good Service" starts before the customer enters your store. When you send a circular, for example, on a new refrigerator to a person who has one that is ten years old, you are attempting to improve his living conditions and save him money on operation costs. This starts your "Good Service." When he comes in to buy, you make sure that he buys something he really needs; for example: when a man comes in to buy a water heater, sell him the correct size  
*(Continued on page 128)*



is the sum of the d.c. and r.f. voltages. For this reason, precautions must be taken to prevent possible arcing. The degree of inductive coupling is often so limited that in some cases optimum coupling (maximum transfer of energy) cannot be obtained.

Capacitive coupling is seldom used unless in conjunction with inductive coupling.

It is possible to couple into a parallel line by tapping directly to one or both resonant lines, however, this should be done only to those lines carrying no d.c. voltage—such as the cathode or filament Lecher lines. Use of d.c. blocking condensers is discouraged.

These are general considerations of the simple push-pull resonant-line oscillator (Fig. 2).

The circuit has good stability of frequency.

Although it supplies a power output somewhat higher than any of the oscillators previously described, it is desirable in many u.h.f. applications to transmit signals of *much higher power*—while retaining good frequency stability.

The output power of the push-pull resonant-line oscillator (Fig. 2) is limited by the plate dissipation of the triodes and by the magnitude of plate current that can flow in the plate circuit.

Increasing the temperature of the filaments may permit greater emis-

sion, but this greatly shortens the life of the u.h.f. triodes, and is therefore undesirable.

A combination of four tubes arranged in *push-pull parallel* would increase the current-carrying capacity of the oscillator. However, the combined interelectrode capacitance would *also* be increased by such an arrangement, and parasitic oscillations would be prevalent. So, despite a higher output power, the upper limit of frequency operation would be limited and general efficiency of the circuit would be only fair. For this reason, use of the parallel push-pull oscillator for ultra-high frequency work *should be avoided*.

Solution of the problem of generating high power of stabilized frequency—with u.h.f. triodes—is a development of the simple push-pull resonant-line oscillator. This new circuit is known as a *ring oscillator*, and consists of *any even number of four or more* of the same triode types arranged concentrically and tuned with resonant lines.

#### Basic Ring Oscillator

The simplest type of ring oscillator consists of four tubes, arranged as shown in Fig. 3. Fundamentally it functions much as any tuned-plate, tuned-grid oscillator—using resonant or Lecher lines.

Leads between plates and grids of adjoining tubes connect to quarter-

wave resonant lines. A common transmission-line tank serves each pair of grids and each pair of plates.

Standing waves of voltage established on sections of the tuned Lecher lines cause the instantaneous voltage on one plate to be 180 degrees out-of-phase with the connecting plate.

This voltage relationship *plus* some inductive coupling inherent between plate and grid circuits *plus* feedback of alternating voltage through the interelectrode capacitance of each tube *combine* to produce the necessary conditions for sustained oscillations.

Quarter-wave grid and plate lines are tuned to resonance by adjusting the position of the shorting bars. At resonance these shorting bars will be at zero r.f. potential.

Half-wave Lecher or coaxial lines are used in the cathode or filament circuit. When tuned to resonance, there will be zero r.f. potential both at the filament and at the shorting bar of each line.

In practice, electrical length of the resonant lines varies considerably from the physical length—because of capacitance effects between the various leads and r.f. ground potential, and between the tube elements and ground. This additional capacitive reactance in the circuit results in resonant lines of physical length considerably *shorter* than the effective electrical length.

Operating frequency of the ring oscillator is varied by adjusting the length of the resonant lines of all three tube circuits; grid, plate, and filament or cathode. The plate and grid resonant lines have the greatest effect on the oscillator frequency.

The u.h.f. energy can best be coupled out of the 4-tube ring oscillator by a single-turn coil placed between, in the same plane, and in close proximity to the two shorting bars of the plate circuit.

Since polarity of the plate resonant lines is in the same direction, current flows in the same direction in each line, and since the resonant lines are a quarter-wave in length and shorted at one end, current will be maximum at the two shorting bars *and flowing in the same relative direction*. This permits easy coupling by induction. The one-turn coil functions much as the secondary of an air-core transformer, feeding energy directly to the u.h.f. antenna by any kind of low-loss transmission line.

Frequency stability of this type of oscillator is good, and is generally independent of the type of u.h.f. triodes employed in the ring circuit.

The arrangement of four tubes provides a power output *double* that for two triodes (of the same type) arranged in a simple push-pull resonant-line circuit.

Since the tubes are effectively *in series*, the effect of interelectrode capacitance is diminished—permitting operation of the ring oscillator at a higher ultra high frequency than

(Continued on page 118)

Fig. 4. Wiring diagram of 24-tube u.h.f. ring oscillator.

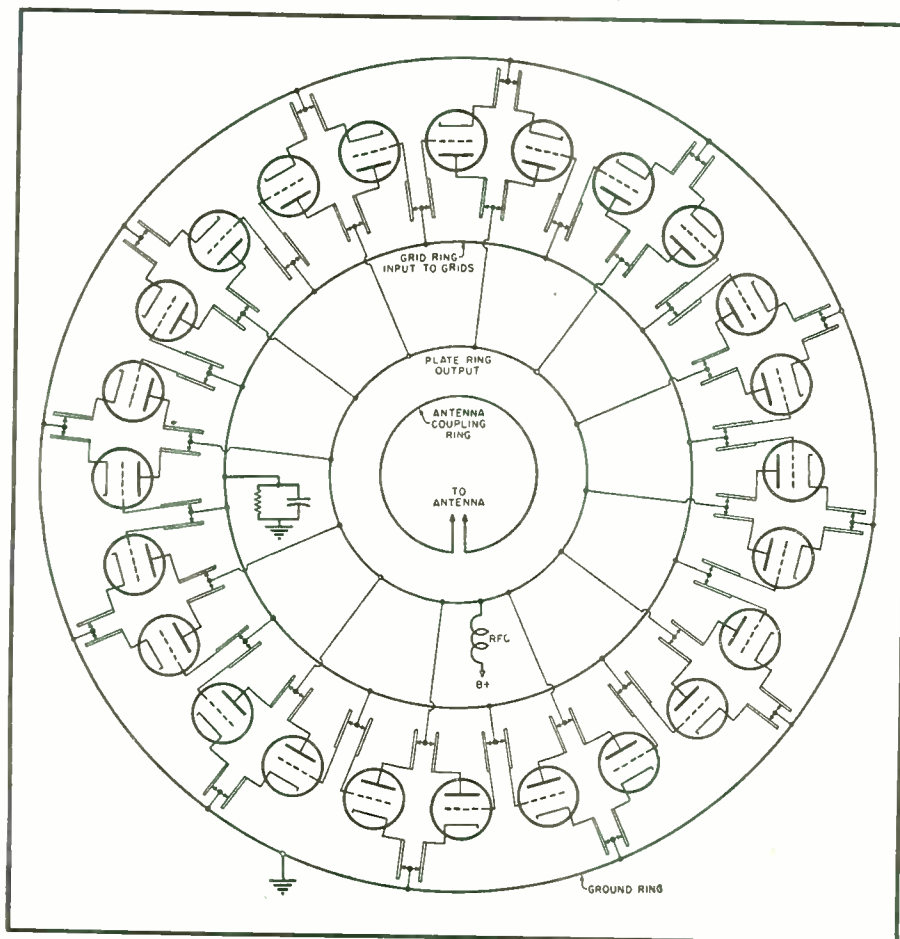



to the flow of current. But to sustain oscillations, reactance of the plate-to-grid interelectrode capacitance must be greater than the inductive reactance of the grid tank circuit.

Grid current in a tuned-plate, tuned-grid oscillator effectively leads the plate voltage by more than 90 degrees, so that voltage fed back to the grid of the tube is exactly in phase with the plate current. This satisfies the oscillator requirement of a *negative resistance* of magnitude sufficient to compensate for all losses in the circuit.

Fixed bias (such as a battery) is seldom used in feedback oscillators. Invariably used is resistance bias, so the circuit will be self-starting and stable operation will be ensured.

To obtain an output power greater than that for a single triode, two or more tubes may be connected in parallel. However, this serves no practical advantage, because all tube interelectrode capacitances are *also* paralleled. This increases the minimum circuit capacitance, decreases the tuning range, and causes the development of parasitic oscillations.

For these reasons, *parallel-connected oscillators are not useful for generating ultra-high frequencies.*

To obtain increased output and *also* greater frequency stability, a double-ended arrangement of the tuned-plate, tuned-grid circuit may be used. In this arrangement (Fig. 1B), two triodes of the same type are connected in push-pull.

Operation of this circuit also depends upon the interelectrode capacitance of each tube. Oscillations are sustained when a sufficient portion of the voltage in the plate circuit is fed back to the grid circuit.

The two triodes are balanced against ground, and each tube handles an alternation opposite in original polarity to that handled by the other tube—so that both alternations are utilized. In this way, even-order harmonics are effectively cancelled out in the plate circuit.

Oscillations normally tend to increase in amplitude until the energy lost in the grid and plate tanks is exactly equal to the energy supplied the tank circuits by the two triodes. Maximum amplitude of oscillations is called the *saturation amplitude*, since the two tubes are driven into the plate-current saturation region of their characteristic curves.

Since interelectrode capacitances of the two tubes are effectively *in series*, theoretically their combined value would be one-half that for a single triode—considerably extending the highest frequency at which the oscillator may be operated.

However, at ultra-high frequencies, the distributed inductance of the tube leads *which are also in series* tends to overcome the advantage of decreasing input capacitance.

### Resonant Lines

Effects of distributed inductance and capacitance in circuit components

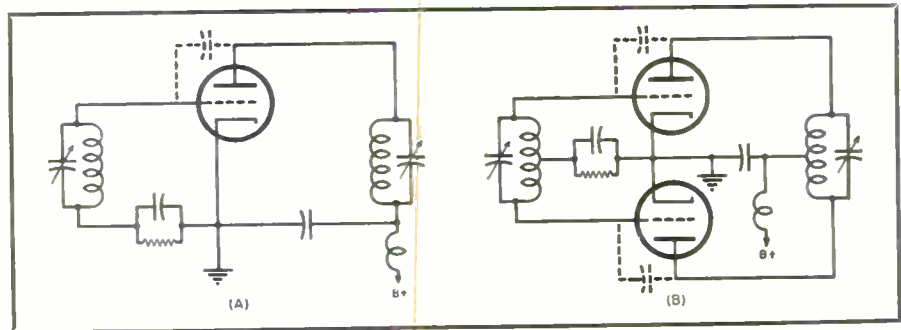

Fig. 1. Basic (A) and push-pull (B) tuned-grid, tuned-plate oscillators.

directly associated with the oscillator can be minimized by using extremely short leads and *resonant lines.*

Use of resonant or Lecher lines also contributes to extreme frequency stability and increased power output of the tuned-plate, tuned-grid oscillator. This takes place because both output power and frequency stability are functions of the "Q" of the oscillator's resonant tank circuits. "Q" is a factor-of-merit, determining the sharpness of resonance of a tuned circuit.

Considering the basic push-pull circuit (Fig. 1B), to obtain a high "Q" required for efficient u.h.f. operation, the r.f. resistance must be low. This would require use of a very large conductor, since u.h.f. current flows only on the outer surface. Also essential is a large inductance, compared to the capacitance of the tank circuit. But this is practically impossible, since interelectrode capacitances of the tube are limiting factors. Therefore the "Q" of a coil-and-condenser tank circuit, even at best, leaves much to be desired for ultra-high frequency operation.

Quarter-wave resonant lines have very high values of "Q," and therefore are ideal as tuned tank circuits for ultra-high frequency operation. High values of "Q"—between 5000 and 10,000—are made possible by the construction of the resonant or Lecher lines, which minimize skin effect. As the operating frequency is increased, the length of the resonant line decreases faster than the skin effect increases. Thus, the value of "Q" increases with frequency of operation.

The basic push-pull circuit (See Fig. 1B) has been redrawn in Fig. 2, showing the substitution of tuned resonant lines for the previous coil-and-condenser tank circuits.

The circuit operates in much the same manner as the basic push-pull tuned-plate, tuned-grid oscillator. Differences are mainly physical or mechanical ones.

Grid and plate terminals of the two triodes are generally connected directly across the open end of their respective resonant lines. Since the high-"Q" circuit is also a high impedance device, direct connections permit the oscillator tubes to work into maximum impedance, thus delivering optimum power output.

The only disadvantage of resonant lines is the shunt-loading effect of the

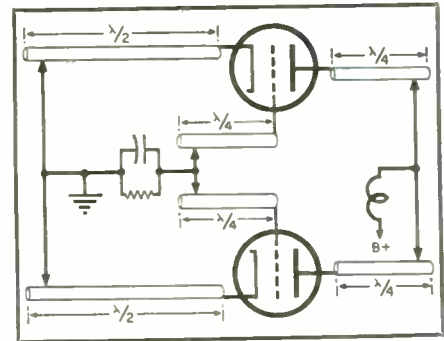

Fig. 2. Ultra-high frequency push-pull tuned-grid, tuned-plate oscillator.

triodes, which loads down the line and diminishes slightly the value of "Q." Resultant operation is something of a compromise: high power output with relatively moderate stability.

Tuning of resonant lines is accomplished by "shorting bars," which resonate the lines at a given operating frequency.

The u.h.f. energy can be coupled out of the push-pull resonant-line oscillator (Fig. 2) by inductive, capacitive, or direct connection.

Inductive coupling to the grid circuit—by means of a one-turn loop—is critical, because coupling may seriously reduce the "Q" of the grid resonant circuit to such an extent that frequency control is influenced.

Inductive coupling to the plate circuit results in an extremely high potential between the plate line and the one-turn coupling loop. This potential

Fig. 3. Schematic diagram of u.h.f. tuned-grid, tuned-plate ring oscillator.

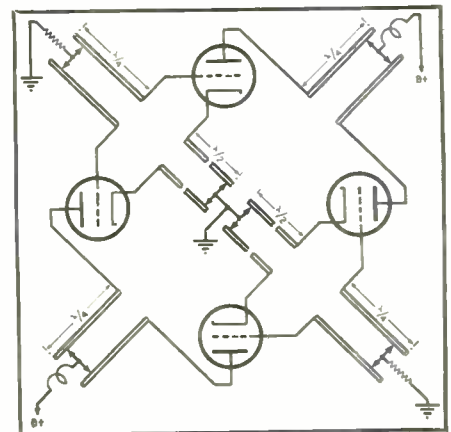



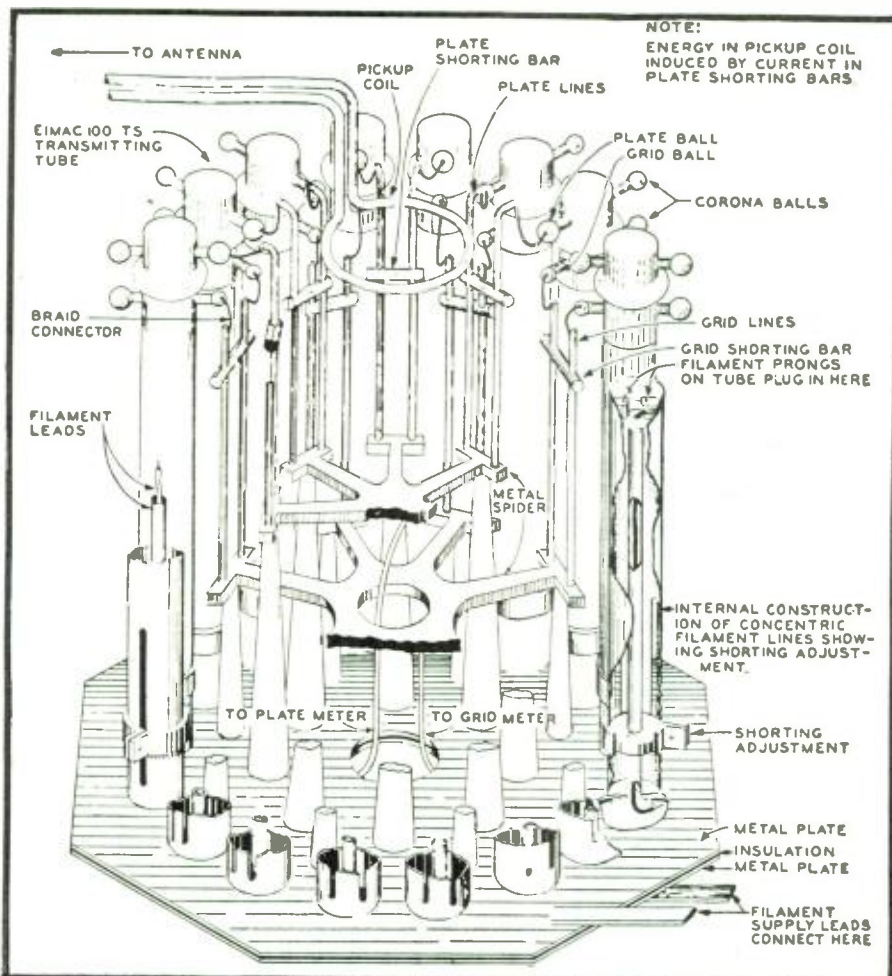

Cut-away drawing of typical ring oscillator used in Army Signal Corps radar equipment, SCR-268, showing circular arrangement of tube and circuit components in one method of construction.

**A wartime development that contributes to the efficient operation of tubes at high frequencies, thus permitting high power outputs to be more readily accomplished.**

# Ring Oscillators for U.H.F. TRANSMISSION

By TOM GOOTÉE

**G**ENERATION of u.h.f. oscillations above 300 megacycles is an impossible task for conventional types of vacuum tubes, because of the effects of interelectrode capacitance and electron transit time, and the effects of distributed inductance and capacitance in tube leads. Special types of high-frequency triodes—developed within recent years—have overcome some of these limitations to a degree, and many of the tubes can function as negative-grid oscillators at frequencies well beyond 1000 megacycles.

But these special triodes cannot

carry large amounts of current, and therefore their output power is relatively low for most u.h.f. requirements. And the old bugaboo: interelectrode capacitance, though of lower magnitude, is *still* present. And it is *still* objectionable, since it limits the highest operating frequency of a vacuum tube.

The only solution to the problem of generating very high power with u.h.f. triodes is by arranging *an even number of them* in a wholly new type of u.h.f. oscillating circuit, known as a *ring oscillator*.

Any type of special u.h.f. triodes

may be used in this arrangement, their combination providing not only a greater power output but also an extension of the *upper limit* of frequency operation in the u.h.f. band. Thus, an even number of four or more triodes will oscillate at higher operating frequencies and with greater power output than would be possible with one or two vacuum tubes of the same type.

Basically, the circuit is a special type of tuned-plate, tuned-grid oscillator.

The development of the ring oscillator is closely allied with the fundamental feedback circuit.

## Basic Circuits

The circuit for the basic tuned-plate tuned-grid oscillator (Fig. 1A) uses a single vacuum tube and a resonant coil-and-condenser tank circuit in both grid and plate circuits.

Action of the oscillator is predicated on the feedback of energy from plate to grid circuits by means of the plate-to-grid interelectrode capacitance within the tube itself.

In operation, alternating voltage fed back to the grid of the triode is 180 degrees out-of-phase with the alternating voltage in the plate circuit, and the grid voltage is of sufficient amplitude to develop the output power required to maintain this voltage.

Frequency of oscillations is slightly *lower* than the resonant frequency of the plate and grid tank circuits. The two circuits need not be in exact resonance with each other, since frequency of oscillations is determined primarily by constants of the plate circuit. The grid tank circuit controls the degree of excitation.

At the operating frequency, both tank circuits offer inductive reactance



controls the amount of negative feedback necessary to reduce the gain of the 6SJ7 tube to approximately 1.

The 3 watt Mazda lamp in the cathode of the 6SJ7 creates a variable resistance which automatically adjusts the amount of negative feedback. The regulation created by this Mazda lamp causes uniform output from the oscillator over the entire frequency range. To determine the capacities of  $C_3$ ,  $C_1$ ,  $R_1$ , and  $R_3$ , a reactance slide rule proves itself quite handy.

To select the approximate frequency, use the following procedure: Assume it is desirable to operate the oscillator at 400 cycles. We look in a condenser box and find that we have two .002  $\mu$ f. condensers. What value of resistance is required? The reactance of a .002  $\mu$ f. condenser at 400 cycles is approximately 200,000 ohms; therefore,  $C_3$  and  $C_1$  condensers become .002  $\mu$ f., and  $R_1$  and  $R_3$  resistors have a value of 200,000 ohms. Inserting these values in the circuit, the frequency should be close to 400 cycles. Commercial tolerances on condensers and resistors are such that exact frequency should not be expected. After the oscillator is put into operation with these values, it is only necessary to vary the resistors or the condensers to hit the exact frequency.

The next operation is to select the correct value of resistance for  $R_2$ . Insert a 10,000 ohm potentiometer in the place of  $R_2$  and adjust this resistor as follows: Reduce the resistance until the oscillator stops oscillating. Next, increase the resistance slightly until oscillation starts. Without changing the setting of the 10,000 ohm potentiometer, remove it from the circuit and check the resistance, inserting a fixed resistor of the same value.

The action of this adjustment is to feed sufficient negative feedback to the cathode of the 6SJ7 to reduce the gain to approximately 1. For minimum distortion output, the resistors and condensers of the RC network should be closely matched. A mismatch of 10% will cause harmonic distortion in the order of 5%. The coupling condenser  $C_1$  must be larger than normally used in a resistance-coupled amplifier, since a small capacitor would cause phase shift. A .5  $\mu$ f. condenser should be considered minimum capacity. The feedback condenser  $C_2$  must have a capacity of at least 5  $\mu$ f. due to the low load resistance created by the negative feedback circuit. If the oscillator is to be used for low frequencies, heavy condensers reduce the possibility of phase shift. If the oscillator is used at high frequencies (above 20,000 cycles), the capacity to ground of circuit components, wiring, and tube capacities becomes important in that this causes phase shift.

The use of a bath-tub type condenser for  $C_1$  is undesirable, since the capacity of the condenser to the can will cause difficulties at high frequency. If phase shift is encountered at high frequencies, it can be corrected by using small capacities from the

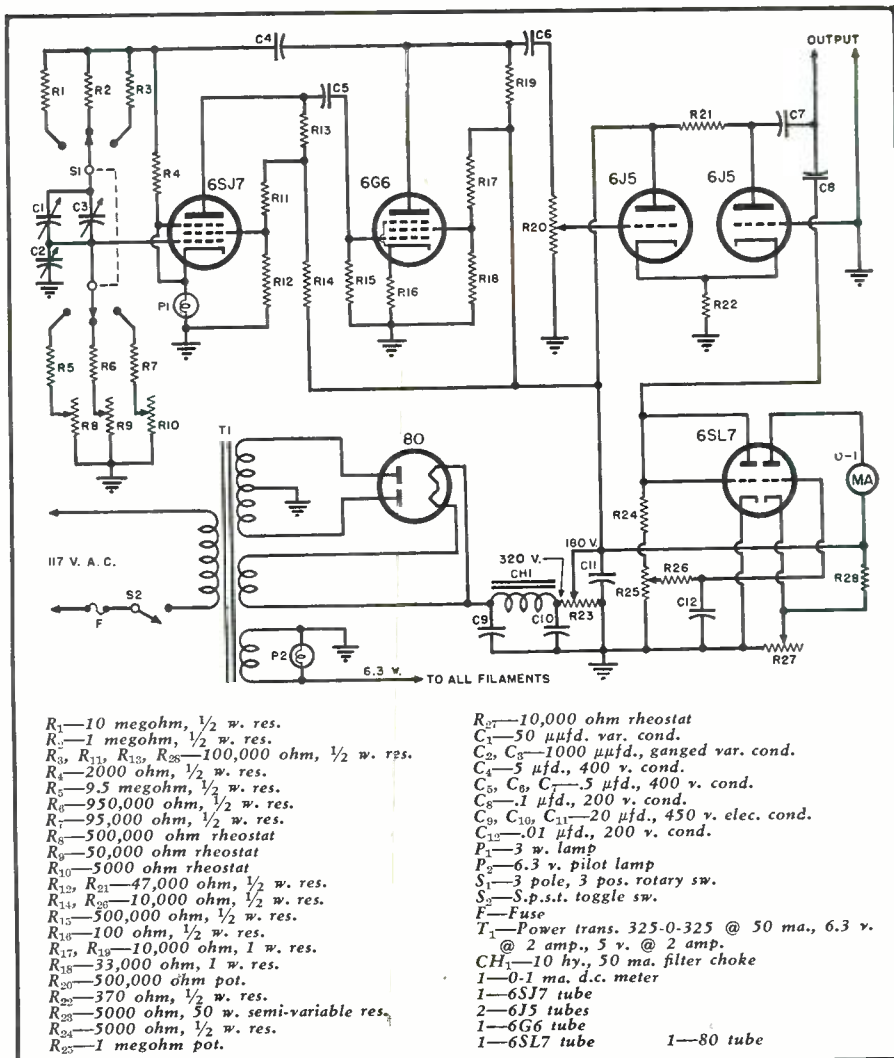

Fig. 2. Schematic diagram of a.c. operated Wien Bridge type audio oscillator.

screens of the tubes to ground. The value of these capacitors will be determined by experimentation. If a variable frequency oscillator is desired, simply substitute a variable condenser for  $C_3$  and  $C_4$  and adjust the values of  $R_1$  and  $R_3$  so the frequency spectrum desired is covered.

It is common practice to use a four-gang variable condenser with two sections tied together for the variable control. If desirable, the capacitors  $C_1$  and  $C_4$  can be fixed and a dual po-

tentiometer used for resistors  $R_1$  and  $R_3$  to vary the frequency. The use of potentiometers for the purpose is rare, since linearity is not certain. If a variable condenser is used, it is necessary to insulate the rotor from the chassis and compensate for the additional capacity to ground by shunting the same amount of capacity across the section that is above ground. By using a variable with a capacity of 450  $\mu$ f. per section and

(Continued on page 74)

Panel view of RC oscillator shows position of various operating controls.





# RC Audio Oscillator

By  
**J. T. GOODE**

Asst. Chief Eng. Packard-Bell Co.

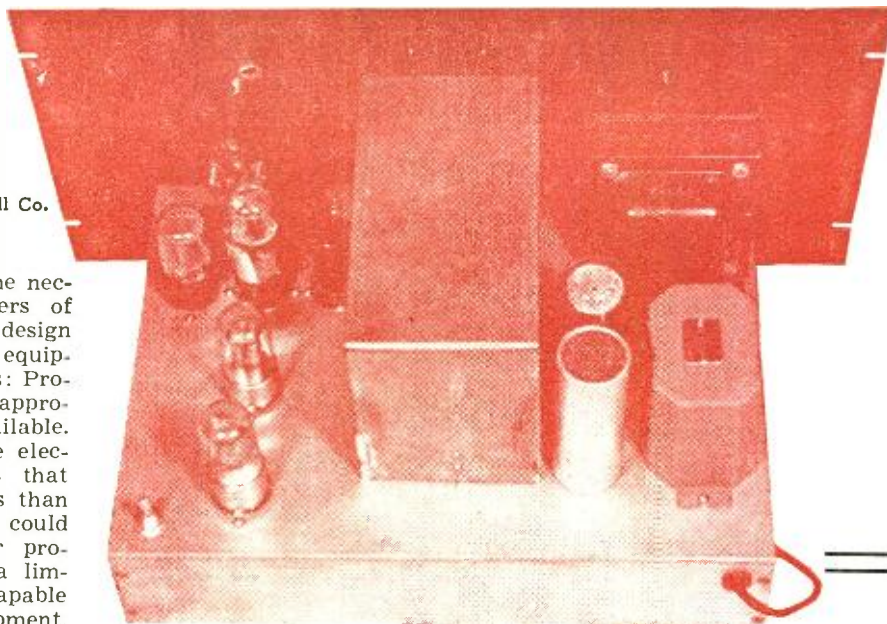

Top of chassis view of commercially built audio oscillator.

**Author presents construction details and a complete technical analysis of a Wien Bridge audio oscillator.**

**D**URING the war it became necessary for manufacturers of electrical equipment to design and construct their own test equipment. Two things dictated this: Procurement; and the fact that no appropriate test equipment was available. Many military contracts in the electronic field had specifications that were so tight that nothing less than precision laboratory equipment could be considered satisfactory for production testing. There were a limited number of manufacturers capable of producing precision test equipment.

Precision test equipment which was available in many instances proved unsatisfactory for production use. The mechanical construction of this equipment was, in some instances, inadequate to withstand production usage. Another difficulty experienced was instability. Some laboratory standards require precise adjustment just before measurements are made, and such procedure is unsatisfactory for production use.

This article covers the operation and construction of an audio oscillator which was designed and used to supplement precision test equipment. It will be possible for a technician to con-

struct this test equipment from the information given and produce a piece of equipment that is equal to precision laboratory equipment.

There are many uses for an audio oscillator if the oscillator is stable, accurate in calibration and free from distortion (less than 1%). The oscillator described in this article incor-

porates the above features. Some of the uses for such a piece of equipment are: Frequency calibration, fidelity measurements, and distortion measurements. For frequency measurements, the calibration must be accurate and remain that way. Fidelity measurements require low distortion and a constant output. Distortion measurements require a harmonic-free voltage source. A voltage source with harmonic content will give an indi-

## Theoretical Operation

To successfully construct a piece of precision test equipment, it is helpful to understand the theoretical operation. Understanding the operation of the equipment puts the builder in a position to make slight final adjustments. The heart of this RC oscillator is, of course, the first two tubes which comprise the oscillator. A simple straightforward two-stage audio amplifier is shown in Fig. 1A. Note the absence of cathode and screen condensers. These condensers are omitted to reduce phase shift. Adding the condensers would increase the gain of the amplifier, but in the case of an RC oscillator, this is not necessary. Referring to Fig. 1B, we simply add RC networks composed of  $C_1R_1$  and  $C_2R_2$  to the grid circuit of the 6SJ7. The cathode resistor becomes a 3 watt Mazda lamp connected to the feedback circuit by  $R_2$  with the addition of  $C_2$  coupling condenser. The condenser  $C_2$  causes the circuit to oscillate by feeding back to the grid of the 6SJ7. The resistor-condenser combinations of  $C_1R_1$  and  $C_2R_2$  determine the time element necessary for such a cycle to take place, which in turn determines the frequency of the oscillator.  $R_2$

Fig. 1. (A) Simple two-stage audio amplifier circuit from which the basic Wien Bridge schematic (B) is derived.

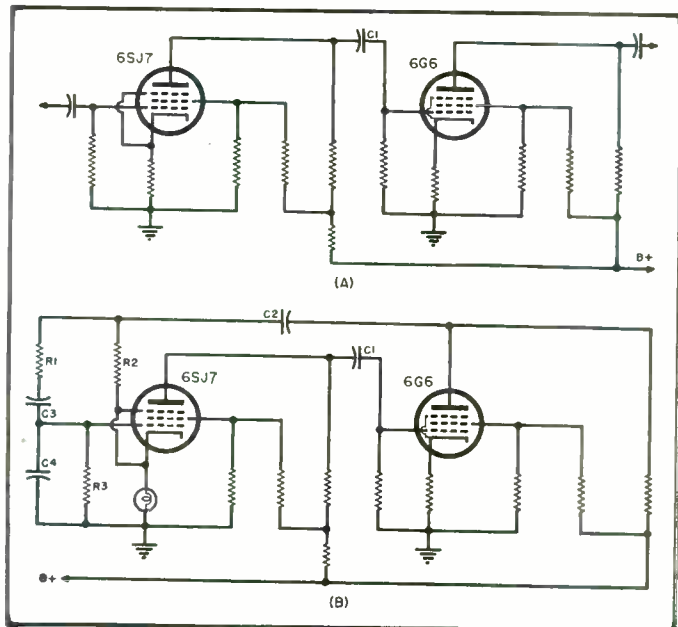



multi-electrode types of mixer and converter tubes cease to operate satisfactorily. Accordingly, they have become popular for use in u.h.f. superheterodyne receivers.

The basic diode mixer stage consists of an input circuit tuned to the signal frequency, an output circuit tuned to the i.f., a source of local-oscillator voltage, and a source of d.c. bias (from a bias battery or a bypassed voltage-dropping resistor). The basic schematic circuit diagram of such an arrangement is illustrated in Fig. 1. In u.h.f. receivers, the signal and oscillator tuning elements may take the form of resonant lines, or cavity resonators. The oscillator voltage may be injected by means of a small coupling loop inserted in the resonant cavity. The oscillator voltage needs to be selected within a range that results in good over-all sensitivity and low noise.

### Operation of Diode as a Mixer

Although the diode is the simplest type of vacuum tube, its behavior as a single-electrode input type mixer has not been clearly understood until fairly recently. One reason for this is that the frequency-conversion process is more complex than in conventional type of mixers in that it is bilateral, i.e., the diode mixer converts in both directions. It converts the applied signal-frequency and oscillator-frequency input voltages to an i.f. output; since this i.f. output and the oscillator-frequency voltage appear in the same circuit (see Fig. 1), it will reconvert them back to a signal-frequency current in the input. As the degree to which this occurs depends upon the impedance of the respective circuit elements to the two frequencies, the effect can be minimized by proper design.

Because no amplification is produced by a diode tube (since it does not contain a grid), no conversion gain is obtained in a diode mixer. Actually, there is a conversion loss, due to losses in the various circuit elements associated with the tube. If the conversion loss is to be held small, the diode must be operated so as to obtain the highest ratio of conversion conductance to average conductance. The upper limit of this ratio is unity, and this is attained only when the mixer-stage impedance is infinite. Thus, circuit losses prevent the attainment of the condition of zero conversion loss in practice, so the diode mixer normally operates with some conversion loss (although it may be kept fairly low by suitable design). This is one of the disadvantages of this type of mixer. However, conventional types of mixer tubes cannot be operated in the u.h.f. region at all, so the diode mixer with its conversion loss is better than no mixer at all.

The diode should be operated with fairly high bias voltage, properly bypassed, and correspondingly high oscillator voltage injection. Under these conditions of operation the output is essentially proportional to the input

Device	Number of Electrodes to which Input is Applied	Type of Coupling Between Oscillator and Mixer	Type of Operation	Type of Tube Used	Comments	Installments of this Series of Articles in which Examples of Electrode and Circuit Arrangements Employed May be Seen
Mixer	Single	Network	Sliding Q-point	Triode, Tetrode, Pentode (12SJ7, etc.)	Separate Osc. and Mixer Tubes Used	Figs. 2, 3, Part 44
Control-grid Autodyne Converter	Single	Network	Sliding Q-point	Tetrode, or R.F. Pentode (6C6, 6D6, 77, 78 etc.)	Osc. and Mixer Electrodes in Same Electron Stream	Fig. 1, Part 46
Converter	Single	Network	Sliding Q-point	Triode-Pentode (6F7 etc.)	Osc. and Mixer Electrodes in Separate Electron Streams	Fig. 2, Part 46
Mixer	Single	Network	Sliding Q-point	Diode Tube or Crvstal Rectifier	Separate Osc. Tube Used	Figs. 1, 3, Part 51
Suppressor-grid Autodyne Converter	Double	Electron	Shifting Q-point	R.F. Pentode (6C6, 6D6, etc.)	Osc. and Mixer Electrodes in Same Electron Stream	Fig. 1, Part 48
Mixer	Double	Electron	Shifting Q-point	Simple Pentagrid Converter (6A8, etc.)	Osc. and Mixer Electrodes in same Electron Stream	Figs. 2, 4, Part 48
Converter	Double	Electron	Shifting Q-point	Modified Pentagrid Converter (6SA7, 6SB7Y, etc.)	Osc. and Mixer Electrodes in same Electron Stream	Figs. 1, 2, 3, Part 49
Mixer	Double	Electron	Shifting Q-point	Pentagrid Mixer (6L7, etc.)	Separate Osc and Mixer Tubes	Figs. 3, 5, Part 49
Converter	Double	Electron	Shifting Q-point	Triode-Hexode Converter (6J8 etc.)	Osc. and Mixer Electrodes in Separate Electron Streams	Figs. 6, 7, Part 49
Converter	Double	Electron	Shifting Q-point	Triode-Hexode Converter (6K8, etc.)	Osc. and Mixer Electrodes in Separate Electron Streams	Figs. 9A, 10, Part 49

Table 1. Superheterodyne mixer and converter classification and summary.

signal voltage, and small variations in oscillator voltage do not appreciably affect the conversion gain, percentage-wise.

Another disadvantage of the diode mixer is that the current it draws places a load on the tuned signal-input circuit at frequencies lower than 30 mc. (approximately), which tends to cause broad tuning. On the other hand, at extremely high frequencies where the input impedance of the conventional types of mixers is very low due to electron transit time effects, the diode places less load on the tuned circuit. This is one of its important advantages in u.h.f. receivers.

The damping effects of the diode on the signal input circuit can be decreased by tapping the diode down on the signal-tuning coil (as shown in Fig. 1) instead of connecting across the entire inductance. The signal voltage reduction caused by the resulting step-down transformer effect is offset by the increased tuned circuit Q resulting from the decreased loading.

The diode mixer, in common with

all single-electrode input type mixers, has a very high oscillator-harmonic response. This is fortunate, for it permits operation of the local oscillator at a comparatively low fundamental frequency (where its stability is good, and its output high), a harmonic frequency of the oscillator being used for the mixing. As a result, the frequency drift of the receiver (which is dependent mainly on the frequency stability of the oscillator) is greatly reduced.

The elements of diode tubes used as u.h.f. mixers must be small, and the cathode and plate should be mounted close together to minimize electron transit-time effects. Special high-frequency diodes are now available for use in receivers designed for operation at frequencies up to the vicinity of 2000 mc. (15 cm.).

### Crystal Rectifiers for Use as Mixers at U.H.F. and S.H.F.

Improved forms of contact rectifiers (such as the new germanium and silicon types) are widely used as the  
(Continued on page 151)

Fig. 2. (A) Sectional view of the Sylvania 1N34 germanium fixed crystal rectifier showing component parts. (B) The Sylvania 1N21B silicon rectifier for mixer use at higher frequencies.

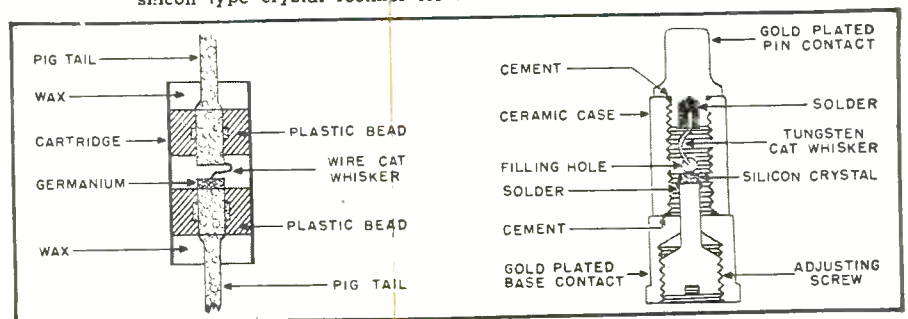



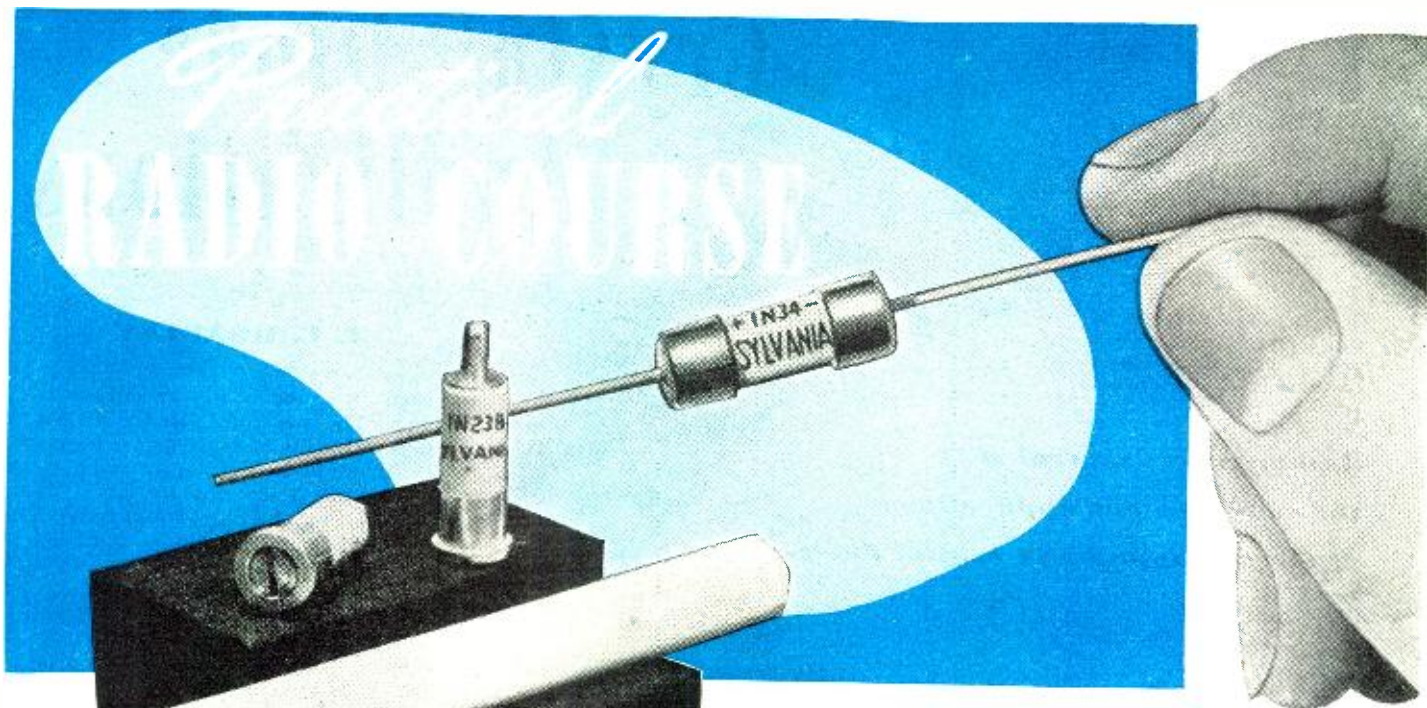

By **ALFRED A. GHIRARDI**

**Part 51. Covering the selection of commercial types of diodes and crystal rectifiers for use as mixers in u.h.f. and s.h.f. radio receivers.**

The 1N34 germanium crystal and the 1N23B silicon type rectifiers.

**T**HE inherent tendency of mixer and converter tubes to give poorer performance at the high frequencies is important now that television, FM and u.h.f. services are becoming widely used. As the operating frequency of receivers is increased, it becomes more and more difficult to obtain satisfactory, efficient frequency conversion.

In ordinary converter tubes, poor oscillator action, together with the undesirable space-charge coupling and transit-time effects limit the use to frequencies of about 30 mc. (10 meters) or so. The more recent im-

proved forms of converter tubes provide satisfactory operation up to higher frequencies; for example, the 6SB7Y improved pentagrid converter tube provides stable, satisfactory frequency conversion in the FM broadcast band (88 to 108 mc.). However, it is generally true that a separate oscillator can be built with better high-frequency characteristics than can a built-in oscillator. Also, because the method used to introduce the oscillator voltage into the mixing part of the system can generally be chosen to better advantage with a separate oscillator than with a built-in oscil-

lator, a frequency converter employing a mixer and separate oscillator tube can generally be designed to provide better high-frequency operation than is obtained with a converter tube. In general, also, mixer tubes are usable at higher frequencies than converter tubes, as the mixer may be used with a specially designed oscillator tube suitable for high-frequency operation (for example the acorn type 6F4 triode oscillator can be used to generate frequencies up to approximately 1200 mc.). Triode-heptodes and triode-hexode converter tubes may be used to fairly high frequencies also.

In the u.h.f. region, the oscillator sections of ordinary converter tubes cease to function altogether. Consequently ordinary converter tubes must be replaced by special types of mixer tubes (diodes), and vacuum-tube oscillators designed specifically for these frequencies. These too, fail to function as the frequency is increased beyond certain values. Above these, other types of frequency converters must be employed, as we shall presently see.

**Use of Diodes as Mixers at U.H.F.**

A simple diode tube (2-element tube) can serve as the non-linear element in a single-electrode input type mixer. During the past few years diode tubes have become appreciated for the advantages they possess for operation in the region of ultra-high signal frequencies where ordinary

Fig. 1. Basic circuit arrangement for a u.h.f. frequency converter stage in which a diode tube is employed as the mixer.

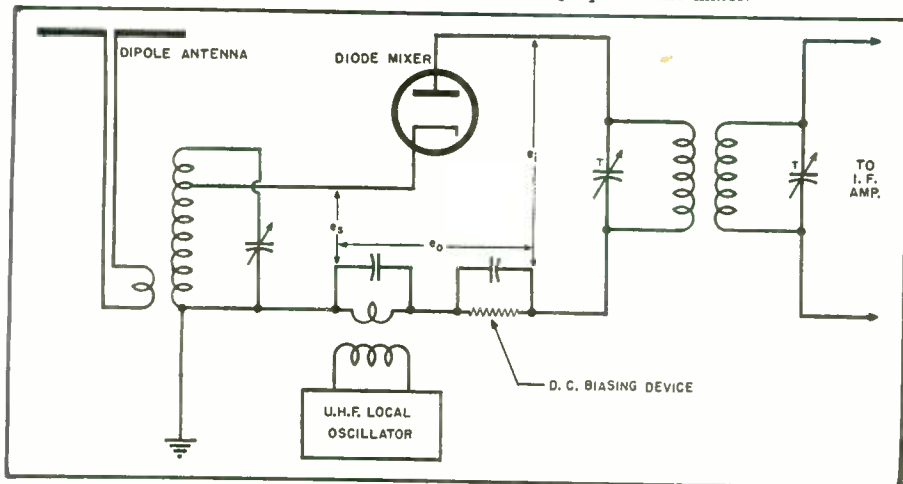



# Crystal Diode Applications

By

J. C. HOADLEY

Fig. 1. Use of crystal diode permits simple and compact construction of a.c. probes.

**Author covers several of the more common applications of the new type 1N34 crystal diode.**

THE Sylvania Electric Company has recently placed on the market a very useful item, a crystal diode called the 1N34. Only slightly larger than a one-watt resistor and made with similar axial pigtail leads, it can be soldered directly into a circuit, eliminating the necessity for a tube socket with its attendant space consumption. If we keep in mind the certain limitations of these superb little rectifiers, we can find many applications for them.

The first thing to consider is the diode's inverse peak voltage rating of 50 volts. This, of course, is rather low compared to a vacuum tube, but we can hook as many of these crystals in series as we like, to obtain a higher voltage rating. Even several crystals still do not take up as much room as a miniature vacuum tube diode.

Maximum current of the crystal diode is limited to 22 ma. average (60 ma. peak) which, incidentally, is more than several times higher than a 6H6 or 6AL5. However, it has several important advantages; among these, no heater and, therefore, no heater cathode capacity or pickup. It is difficult to connect a vacuum tube diode so that the cathode is at a high positive potential because of heater cathode leakage, so a separate heater winding must be provided and, even then, there is the heater cathode capacity.

Our diode's input capacity is in the order of 3 micromicrofarads, which is very low. Its forward resistance is lower than a vacuum tube diode and its back resistance is also lower. The two resistances are in the order of 100 ohms and ½ megohm, although the back resistance varies with the individual units and applied voltage. It is desirable to choose a load resistance for the crystal diode which will cause no appreciable effect. There are applications where this back resistance is advantageous, as we get a diode with a load resistance thrown in free.

A very useful characteristic of this diode is its frequency response. It is flat from zero to 100 megacycles. This makes it ideal for use as a meter rectifier, among other things. The usual a.c. voltmeter using a copper oxide rectifier has relatively poor frequency response, falling off above several thousand cycles-per-second. It is inexpensive to convert your a.c. voltmeter to one whose frequency response is flat as far up the frequency range as the loading and other conditions will allow.

Keep in mind that not over thirty odd r.m.s. volts should be applied to one crystal. This can be overcome by series connection of two or more crystals. As the high frequency voltages which are usually measured are seldom over 100 volts, and are usually much less, this is not as serious a restriction as would first be supposed.

Let us consider some applications of this versatile little diode. The first one to come to mind is its use as a detector. From the beginning of radio, crystals have been used for detectors. They have fallen into disuse in recent years because of the critical adjustment of catwhiskers, etc. This problem has been solved, however, and the 1N34 is permanently adjusted.

In Fig. 2 is shown a detector circuit for use in a superheterodyne or tuned radio frequency receiver; or, if preferred, the circuit in Fig. 4 may be

used as it has a higher output voltage. The sizes of  $R_1$  and  $C_1$  in Fig. 2 depend on the audio response required. It functions as a filter to remove the radio frequency component without attenuating the higher audio frequencies. We will probably want automatic volume control.

Fig. 3 shows the connection for a detector and a.v.c. rectifier. Notice that the diodes are reversed, as a negative voltage is needed for a.v.c. which determines the polarity of the a.v.c. diode. We then connect the detector diode with the opposite polarity to even up the load on the last r.f. or i.f. stage. Of course these diodes can be used to replace the diode tubes in an FM discriminator.

For the serviceman, one of these small diodes, a condenser and resistor made into a miniature probe and connected directly to a pair of earphones, makes a convenient signal tracer which may be slipped into the pocket and will never require new batteries or any attention.

The photograph in Fig. 1 shows a neat way to construct a crystal probe. First, saw the metal shell from a medium size metal tube such as the 6SJ7 or 6SK7 and cut an insulating disc that fits snugly into the open end. Drill and tap several holes for 2-56  
(Continued on page 153)

Fig. 2. Detector circuit designed around the 1N34 crystal diode which may be incorporated in either superheterodyne or TRF receivers.

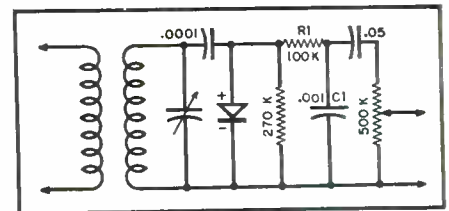
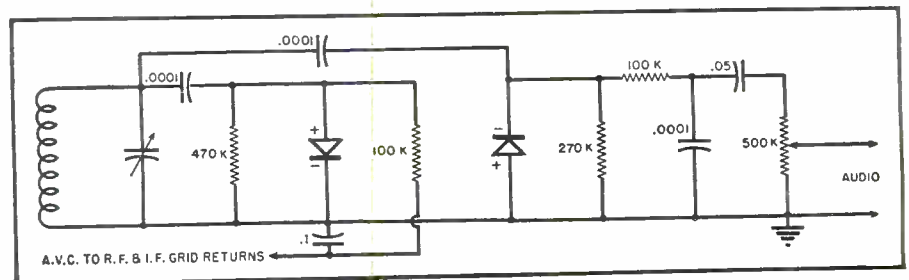

Fig. 3. Two crystal diodes replace a vacuum tube in this detector and a.v.c. circuit.







By CARL COLEMAN

**A**LTHOUGH the recent maritime strike is hardly over and there is talk of another, the *American Merchant Marine Institute* President F. J. Taylor, recently predicted uninterrupted maritime activity for some time to come. . . . It was pointed out that with recent wage increases in all groups of personnel there would be no reason for another stoppage in the maritime shipping field.

During the recent strike there was a strong tendency to transfer cargo originally scheduled for American vessels to foreign flag ships in order to eliminate delays due to the labor troubles, it should be recognized by the unions that such action by concerns shipping goods to foreign ports will take place more and more and American shipping must operate continuously if it is to compete with such foreign vessels operating steadily out of American ports . . . that these foreign firms are really out for the trade can be seen in some of the recent arrivals of new foreign ships, a recent arrival, the Houffalize (Belgian), an 18½ knot vessel of 11,000 tons with the usual accommodations for 12 passengers. . . . The vessel is a triple screw job, diesel powered . . . this is the second of three such ships to be operated by the Belgian Line. The first of the three was the Stavelot which made her maiden voyage last spring.

Various other foreign firms are either building new ships or, in some cases, purchasing American built vessels and converting them for their own runs and services.

**A.** C. WELLS reported back in New York after a vacation. . . . M. C. Wilson arrived in port recently and after being around for some time contracted pneumonia and was hospitalized for some weeks—MC will be up and around shortly we hope.

Alan Van Siclen recently relieved aboard his Mariners

Splice and started for the West Coast—Alan has ambition for a run down the west coast from Frisco to the Canal. . . . Dave Grossert reported back in the big town and shipping out recently. Harold Koch back at Charleston after a vacation home in the Mid-west. . . . Ed Stetson down to Philadelphia for several days, says he likes Jersey City better. . . . Joe Malony unreported the past month. . . . D. K. Crosby around town for a while to say "hello" to the old gang. C. E. Williams off a while ago to do a little fishing and hunting—and ran afoul one of those black kitties with the white stripe! CE came off a close second.

**L**AATEST reports from the *Maritime Commission* reveal that about fifty-one per-cent of the world's merchant shipping tonnage is under the American flag compared with only fourteen per-cent in pre-war days of 1939. There is over 50 million tons under the U. S. flag and nearly five million more under various foreign flags is owned by United States shipping outfits. England, which is constructing most of the new tonnage now being built, shows a decline from the 1939 figure of 12,798 to 12,445 in 1946. However, world tonnage increased from 80,601,000 to 99,220,000 tons.

Wartime construction of about 2000 Libertys accounted for this trend. Only other major maritime nation to show

an increase in addition to the United States was Soviet Russia whose merchant fleet increased from 2 per-cent to three per-cent of the world's merchant shipping tonnage.

**G**ENERAL ELECTRIC recently announced the development of a new and lighter radar unit for aviation, designed to eliminate some of the hazards of flying in darkness, fog, or storms—the unit has also been considerably simplified in operation over the 150 pound APS-10 radar built by GE for the Air Forces during the war.

**T**HE *Maritime Commission* did announce recently that 1695 vessels were now in Merchant Marine Reserve Fleet anchorages throughout the country as of Oct. 15th. . . . During the period Sept. 15th to Oct. 15th 46 vessels were withdrawn for sale, service or scrapping, it was announced.

Among the new shipping interests is the announcement of the completion of reconversion of the "America"—largest of the U. S. built ships which has been completely overhauled since her "West Point" days and is said to be one of the finest vessels afloat for the North Atlantic passenger trade—the vessel left Newport News recently (where she was built) for New York to shortly engage in her prewar trans-Atlantic trade.

**S**ALES reported in progress are 50 Libertys to Italy, Holland also reported after quite a number of these craft—Holland-American Line looking for four Victories . . . France reported after about 75 vessels. . . . Matson has shifted four ships to Panama registry recently.

RMCA's new radar unit reported ready for installations aboard the merchant fleet. *Raytheon* recently fitted out the Drottningholm with new radar gear—a new design commercial unit for marine use.

**S**TEAMSHIP companies still in a struggle with CAB trying to get charters for overseas flying—CAB still interprets the law in a manner which prohibits steamship lines from operating airlines, American Export the only shipping line ever to get into the air business was forced to get rid of its airline by CAB.

Waterman, Matson, United Fruit, Grace and American South African are among those seeking permission for airlines in conjunction with their sea routes.

**C**ONGRATS to Lt. Col. F. J. Shannon, who received the air medal for his part in the flight of the "Dreamboat" from Hawaii to Cairo. . . . Frank in civilian life is connected with WCAU. . . . Fred Pratt still out of town and has not been seen for some time. . . . S. G. Hopkins and E. H. Robinson, recently cited by WSA, just before the end of that unit, for their part in wartime aboard their vessels.

. . . . . 73

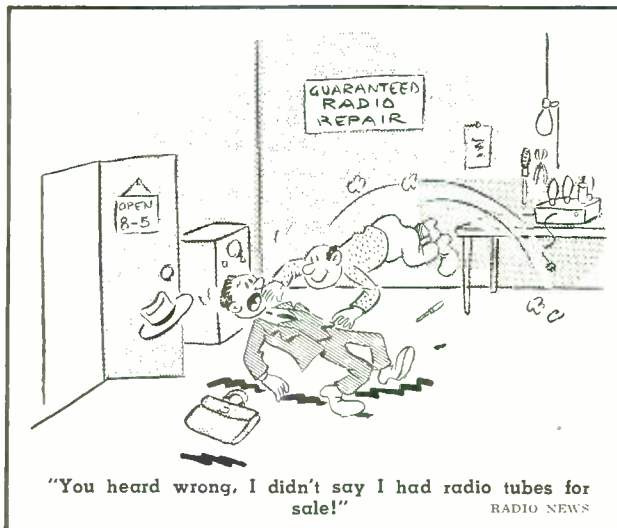

"You heard wrong, I didn't say I had radio tubes for sale!"

RADIO NEWS



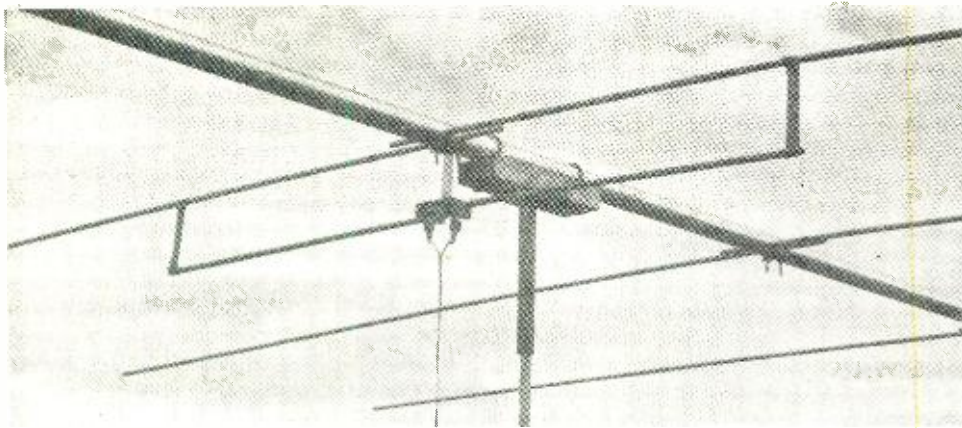

Fig. 2. Photograph shows close-up view of "T" matching section.

port and to rotate such arrays have been fully described in the literature or will suggest themselves to the ham. In the illustrated mounting the tube frame was grounded to the pipe flange by a short length of copper braid, inasmuch as the supporting pipe and chimney bracket are permanently grounded to a vent pipe in the roof of the house for lightning protection. A potential method for rotating the array is to bring the base end of the supporting pipe through the roof. A section of small o.d. tube may be inserted inside the supporting pipe, mechanically secured to the 2 x 4 and provided at its lower projecting extremity with a wheel or lever for rotation.

For this type of beam the "T" match, delta match or folded dipole feed is most easily adaptable. However, by drilling oversize the frame holes which carry the driven element, insulated bushings may be inserted at this voltage node to insulate each quarter wave of the antenna section from the frame so that other types of feed may be used.

The "T" match shown in Figs. 2 and 6 was selected for this particular application and the "T" section is made up from two 33 inch lengths of 1/2 inch o.d. thin-wall aluminum tube, the same diameter as the elements. A small block of 1/2 inch thick bakelite serves to mechanically connect and electrically insulate the inner fed ends of the "T." The block is so dimensioned that the stagger distance of 1.5 inches is maintained in the "T" section and is supported from the tube frame for rigidity. The shorting straps, which are adjustable along the length of the elements and "T" section, are formed from one sixteenth inch thick aluminum sheet, 1 inch wide. They are provided at each end with a hole for the passage of a bolt and wing nut to tightly clamp the tubing. By loosening the two wing nuts on each shorting strap, each strap may be slid in or out along the length of the element to minimize standing waves on the feed line, after the beam has been tuned by any one of several tuning procedures outlined in the various antenna handbooks. 300 ohm twin-lead type feeders are used with

the illustrated beam and connected as shown in Fig. 6.

Before final installation of the illustrated "T" section made from aluminum tube and aluminum shorting straps, a temporary "T" section using No. 8 copper wire was used with excellent results. If a wire "T" section is used the vertical spacing may remain 4 inches and the distance "T" determined by noting the standing wave ratio.

A convenient, qualitative check for standing waves on the twin-lead type line may be made by running a neon bulb along the line for a distance of some ten feet, on ten meters. If the bulb brilliancy remains reasonably uniform, the line is reasonably flat. If the brilliancy varies, the distance "T" should be readjusted. The total distance "T" for the separation of the shorting straps will be somewhere between 40 and 60 inches. While the illustrated beam has been adjusted for maximum forward gain and minimum standing wave ratio at 29 megacycles, it has been used without readjustment from 28.1 to 29.4 megacycles. At these frequency extremities the standing wave ratio becomes appreciable and coupling to the final tank must be al-

tered. However, with 600 watts input to a BC610E transmitter the 300 ohm twin-lead does not break down.

The staggered element design is not limited to the particular element or frame sizes shown. In the illustrated array the 1/2 inch thin-wall aluminum elements seemed rather light and flexible. Some lengths of thick-wall aluminum pipe were found in a war surplus stock, the o.d. of which would drive fit the i.d. of the 1/2 inch elements. Therefore, 2 1/2 foot lengths of the pipe were driven into the butt end of each of the quarter-wave elements.

In working with arrays using a metal center structure of appreciable diameter, the writer has noticed that the popular formulas for calculating the tip-to-tip element lengths seemed to give elements which were too short according to maximum forward gain measurements. It has been determined roughly that by adding the width of the frame to the calculated lengths such an effect is obviated.

Accordingly, it is to be noted in Fig. 1 that the dimensions for  $D_1$ ,  $D_2$ ,  $A$  and  $R$ , calculated from Table 1, are measured from the outer wall of the 2 inch tube frame to the element tip. The formulas give the dimensions for each quarter-wave section of each element, which is the measured distance from opposing sides of the tube frame to the tip of each corresponding quarter-wave element, or the distance which each quarter-wave element projects from the side of the frame. The total over-all cut length of the various quarter-wave sections, to permit adjustment from 28 to 30 megacycles, is:

$$\begin{aligned} D_1 \text{ \& } D_2 &= 8' 2'' \\ A &= 8' 6\frac{1}{4}'' \\ R &= 9' 0'' \end{aligned}$$

It will be obvious from this that this beam requires for the elements, 4 lengths of tubing 8' 8" long, 2 lengths 9' 0 1/4" long and 2 lengths 9' 6" long; for the frame, 1 length of larger o.d. tubing 12' long; and for the "T" section

(Continued on page 88)

Fig. 3. 10 meter antenna constructed by author. Main support is made of 1/2" galvanized pipe.

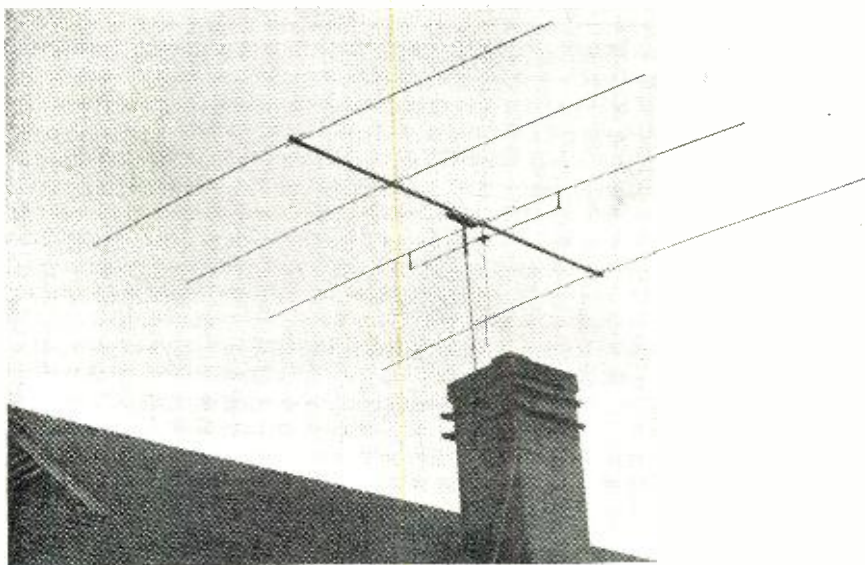



# New Parasitic Beam Design

By  
**R. G. ROWE, W2FME**  
Consulting Engineer

## Design characteristics of a 4-element, close-spaced antenna array featuring novel adjustable element length. Data applies to arrays for 28 mc. and up.

**T**HE following article describes a four-element, ten-meter, close-spaced array based upon the Plumber's Delight, but having a distinctive feature in the way of adjusting element lengths not heretofore disclosed to the best of the writer's knowledge.

While the design principles are not limited to any practical number of elements or element spacings, from a mechanical standpoint they can be best applied to arrays for 28 megacycles and higher, due to the relatively

short element lengths required at these frequencies.

The novel mechanical design arises from the method of staggering quarter-wave sections of each element along the central carrying tube, as shown in Figs. 1 and 3, thereby permitting simple adjustment of element length from the center of each half-wave section and eliminating the need for telescopic sections. The protrusion of the short length of the butt end of each quarter-wave section does not deleteriously affect the gain or pattern of the array. The beam is made entirely from aluminum, with the exception of one small piece of insulation in the "T" matching section, later to be described. The metal frame, elements, matching section, and feed line are all electrically connected, permitting a single, permanent ground connection to afford protection from lightning and static discharge.

The central carrying structure, or "frame," for the particular ten-meter beam illustrated is made from a 12 foot length of 2 inch o.d. aluminum

tube with a wall thickness of one sixteenth inch. An inspection of Fig. 4 shows how the tube is drilled at the spacings indicated in Fig. 1. A "stagger" distance of 1.5 inches was used in this particular embodiment, with 0.5 inch diameter thin-wall elements. The stagger distance should be minimized as much as possible, becoming progressively critical at higher and higher frequencies. The frame holes should provide a snug fit for the butt ends of the elements, yet permit them to slide when the clamping bolts are loosened. Small holes through the bottom of the frame, indicated in Fig. 4, are drilled to permit the insertion of the so-called "J" bolts. These bolts may be formed from eye bolts, "U" bolts or bent up from straight bolts. Tightening the wing nuts securely locks the elements in place, whereas loosening them slightly permits simple adjustment of the length of each quarter-wave section.

The quarter-wave sections may be scribed or otherwise ruled off at their butt ends to facilitate reading the over-all length. In the illustrated beam, short pieces of friction tape were wound around each element near the butt end at a predetermined, measured length from the tip. Thus, by measuring the short distance from the frame to the tape, it is possible to balance the length of each section easily as well as to mentally calculate the over-all length rapidly, without using a long rule or tape to measure the tip-to-tip length. All adjustments and measurements may be made at the center of each half-wave section, greatly facilitating installation and tuning.

Fig. 5 indicates a possible method for mounting the frame at its mechanical balance point on a short length of grooved 2 x 4 with "U" bolts. A pipe flange is screwed to the underside of the 2 x 4 to take a short 12 inch length of pipe, the i.d. of which just will slip over the o.d. of the supporting pipe, providing a bearing for rotation. In the illustrated arrangement, a 1/2 inch galvanized water pipe is used as the supporting pipe, for inasmuch as the array is close to the chimney bracket and the supporting pipe is short, greater rigidity is not required. Many other ways to sup-

QUARTER-WAVE SECTION	LENGTH IN FEET
D1-D2	$\frac{225}{f(\text{mc.})}$
A	$\frac{234}{f(\text{mc.})}$
R	$\frac{246}{f(\text{mc.})}$

Table 1. Formulas for calculating the various element lengths (shown in Fig. 1) for specific frequencies.

Fig. 1. Diagram shows how the 12 foot, 2 inch o.d. aluminum tube is drilled to support the various antenna elements. Constructed unit is shown in Fig. 2.

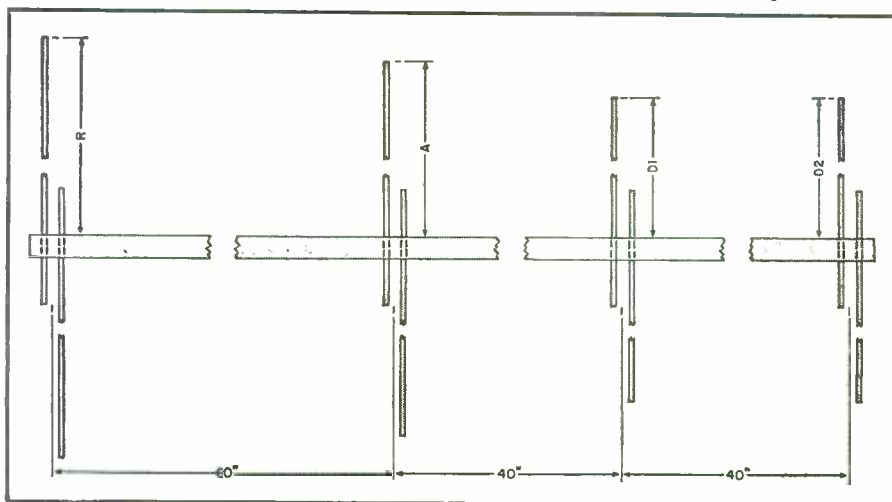



ing the positive voltage to which the grid leaks of the tubes are returned. In this circuit, the frequency is almost directly proportional to the positive bias voltage obtained from potentiometer  $R_{15}$  which is part of a voltage divider connected across the high voltage power supply. Consequently,  $R_{15}$  functions as the transmission speed control but does not change the relative lengths of the dots, dashes and spaces. This is a front panel control and is mounted just above the control switch lever. It may be provided with a scale calibrated in words-per-minute as will be described in connection with the alignment procedure.

It was found that  $R_5$  and  $C_5$  shunted across the relay coil provided the damping necessary to reduce the transient voltage induced in the coil when the current in  $V_{1B}$  changes suddenly at the beginning and end of each mark. Resistors  $R_9$  and  $R_4$  serve to stabilize the operation of the circuit and to enable positive, immediate, response when the control switch is closed.

### The Control Circuit

Thus far, the timing circuit has been treated as a free-running multivibrator sending a continuous sequence of marks. The control circuit functions to start and stop the timing circuit and to determine whether dots or dashes are to be transmitted. It operates in response to manipulation of the control switch, or key, which is shown in the neutral position.

When the control switch is in the neutral position as shown,  $V_{1B}$  is biased beyond cut-off by the voltage developed across the common cathode resistor  $R_7$ . This negative bias is developed by the plate current of  $V_{1A}$ , which is conducting steadily because its grid leak is returned to the positive bias at  $R_{15}$ . It will be noted that the grid leak of  $V_{1B}$  is returned to the negative end of  $R_7$  through a very high resistance,  $R_5$ .

Now, suppose that it is desired to transmit dashes. The control switch is moved to the dash contact, thereby connecting the positive bias from  $R_{15}$  to the grid leak of  $V_{1B}$ . The initial voltage surge is coupled through  $C_2$  directly to the grid  $V_{1B}$ , driving the grid voltage up to zero immediately and causing plate current to begin flowing through this tube. Simultaneously,  $V_{1A}$  is cut off because, as previously explained, only one of the tubes can conduct at any given time. Thereafter, the circuit operates as a free-running multivibrator, forming a sequence of dashes which continues as long as the control switch is held in the dash position.

The duo-diode,  $V_2$ , operates as an electronic switch. When the control switch is moved to the dot contact, the multivibrator begins operation as previously explained because one section of  $V_2$  conducts current from  $R_{15}$  to the grid leak of  $V_{1B}$ . The other section of  $V_2$  simultaneously shunts  $R_{12}$  and  $R_{13}$ , thereby reducing the time constant of the  $V_{1A}$  grid circuit to one-third of its

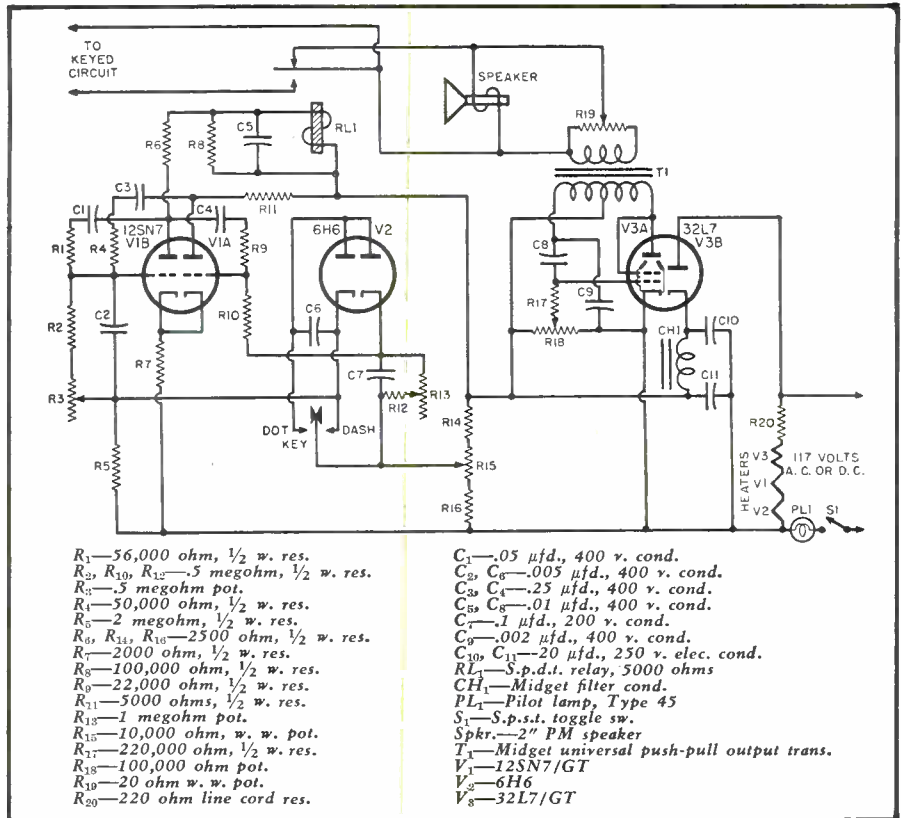

Schematic diagram of automatic key. Fundamental frequency of oscillator is variable from approximately 400 to 2000 cycles-per-second.

former value and making it equal to the  $V_{1B}$  grid circuit time constant. These two circuit changes are accomplished with only a single circuit through the control switch. The current keyed by the switch contacts is very small, about one-half milliampere or less according to the setting of the speed control.

The internal resistance of the diodes is about 1000 ohms, very low relative to the resistances which they shunt, and is considered to have negligible effect on the circuit operation.

Condenser  $C_7$  prevents a dot from being changed to a dash in the event the control switch is opened in the middle of a dot. In that event,  $C_7$  shunts sufficient current around  $R_{12}$  and  $R_{13}$  to be considered a momentary short circuit for sufficient time to permit the formation of a correctly timed dot.

It would be undesirable to clip a dash too short by opening the control switch before the final dash of a sequence is completed. This possibility is avoided here by providing negative

(Continued on page 148)

Rear view of the completed unit. Ventilation is provided by perforating the chassis, and back and bottom of cabinet.

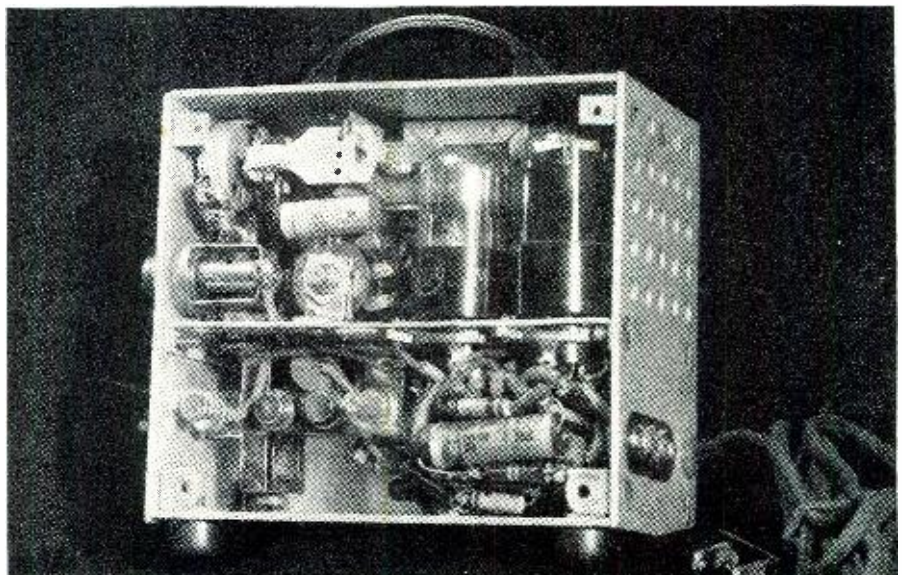



# The ELECTROPLEX— a new automatic key

By JULIAN T. DIXON, W1AJY



Two views of the completed automatic key. It is capable of handling a speed range of from 9 to 35 words per minute.

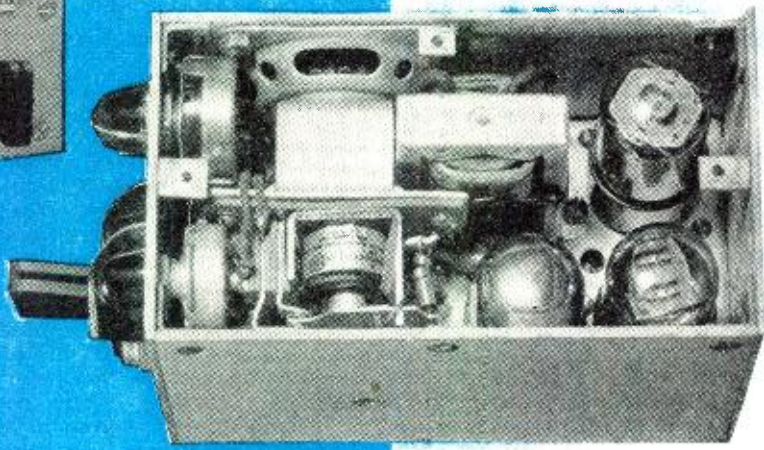

ONE item of equipment which is long overdue in many radio-telegraph stations is a dual-automatic key—one which forms both dots and dashes automatically. The *Electroplex* is the result of an effort to provide a practical dual-automatic key which might be acceptable for general use by the radio operating fraternity. It is of simple design, yet has a number of features which in combination give the *Electroplex* definite advantages over previous dual-automatic keys.

This unit is designed to eliminate to a considerable degree the need for precise timing on the part of the operator. It incorporates circuits which selectively form sequences of dots or dashes with each dot, dash, and intervening space being timed much more accurately than is possible with ordinary hand sending. It is controlled by means of a single-pole double-throw switch, thereby minimizing the number of mechanical adjustments required. This simplified control switch assures accurate and easy manipulation at high speed. It is not, however, primarily a high speed key. The model described here has a speed range of from nine to thirty-five words per minute, adjustable by means of a single potentiometer to the desired value. Thus, it is suitable for use by both the beginner and the more advanced operator. In fact, the beginner's problems are simplified appreciably because the key takes over the job of timing each dot and dash correctly. It will be shown how the key completes a correctly timed dot or dash even though the control switch may be opened in the middle of one of these marks.

## ***Design and operation of dual automatic key—one which forms both dots and dashes automatically.***

The model illustrated comprises four basic components which will be described in the following order: (1) timing circuit, (2) control circuit, (3) audio frequency monitoring oscillator, (4) power supply.

### **The Timing Circuit**

The timing circuit utilizes a dual triode tube,  $V_{11}$ , the respective sections of the tube being designated  $V_{1A}$  and  $V_{1B}$ . This tube and its associated circuit elements are connected in a specialized form of multivibrator circuit designed particularly for this key.

One important characteristic of multivibrator circuits in general is that plate current flows in one and only one of the two tubes at any given time. In a free-running multivibrator, the tubes conduct plate current alternately. They approximate a switch which changes the flow of plate current from one plate load resistor to the other at a frequency which is determined by the circuit design. It will be noted that the coil of relay  $RL$ , is part of the plate load of  $V_{1B}$ . Thus, when  $V_{1B}$  conducts, the relay contacts close and when  $V_{1A}$  conducts the contacts open.

It will now be seen that when  $V_{1A}$  conducts a space is formed and when

$V_{1B}$  conducts a mark (either a dot or a dash) is formed. So, in order to transmit a sequence of dashes  $V_{1A}$  should be non-conducting three times as long as is  $V_{1B}$  during each cycle. This proportion is obtained by making the time constant of the grid circuit of  $V_{1A}$  three times as great as the time constant of the  $V_{1B}$  grid circuit. These time constants are approximately the product of the grid leak resistance and the capacitance of the corresponding grid coupling condenser. The coupling condensers,  $C_3$  and  $C_1$ , have equal capacitances so that the non-conducting time of each tube is approximately proportional to the magnitude of its grid leak resistance. The grid leak resistance of  $V_{1A}$  is the sum of  $R_{10}$ ,  $R_{12}$  and  $R_{13}$ , while the grid leak resistance of  $V_{1B}$  is  $R_2$  and  $R_3$  in series.

The potentiometers  $R_1$  and  $R_{13}$  are provided for exact adjustment of the spaces and dashes, respectively, with relation to the dot length which is determined principally by  $R_{10}$ . These potentiometers are screwdriver adjustments which need not be changed after the correct settings have been determined by means of a simple alignment procedure to be described later.

The frequency of a multivibrator may be changed conveniently by vary-

**RADIO NEWS**



or gain reading is required. The present equipment provides both a visual indication of relative signal strength by means of a vacuum tube voltmeter (for stage gain and signal level measurements), and an aural indication of signal characteristics and fidelity by means of a high-gain audio amplifier, with an earphone output for greater sensitivity when required.

b. The sensitivity is sufficiently high to indicate the presence or absence of signal in every section of the receiver.

c. Most early signal tracers made use of the diode type vacuum tube voltmeter circuit requiring additional components making a more cumbersome and complex unit. Many models used a tuned r.f. amplifier which, while quite efficient, takes longer to set up and may require constant adjustment. The circuit used in this instrument makes use of a triode grid leak detector which requires no tuning or adjustment in operation.

d. The input impedance of the grid detection circuit used is so high that there is no loading of the circuit under test up to frequencies above 10 mc.

e. The wide frequency range, which extends from low audio frequencies to over 10 mc., makes the instrument useful for measurements on all types of audio circuits, i.f. and r.f. sections of broadcast receivers, audio and i.f. sections of FM receivers, and video amplifiers. This frequency range provides the maximum benefits from the viewpoint of flexibility of operation and simplicity of design, since if the bandwidth were to be extended to accommodate all frequencies which might be required in the future it would be necessary to extend the response to well over 500 mc. to include the high frequency television band in which color television broadcasts are now being transmitted. Such a procedure would obviously be impractical in the design of a test instrument such as this. (If, however, in the future it should become desirable to perform r.f. measurements in FM and low-frequency television receivers, it is a simple matter to construct a v.h.f.-u.h.f. rectifier probe using a 1N34 crystal diode detector whose output would feed into the signal tracer.)

f. The circuit has been designed to provide a maximum of operational flexibility and increased sensitivity, without introducing excess complication by duplicating any functions of any of the other instruments which the serviceman customarily carries along on an outside service call. Thus, there is no provision for the measurement of any d.c. voltages, since they can just as easily be measured by means of the volt-ohm-milliammeter which is invariably present. By designing the instrument to be battery operated, this signal tracer has been made as completely portable as the battery operated volt-ohm-milliammeter.

The schematic circuit diagram of the new signal tracer can be seen in Fig. 4. The circuit consists essentially

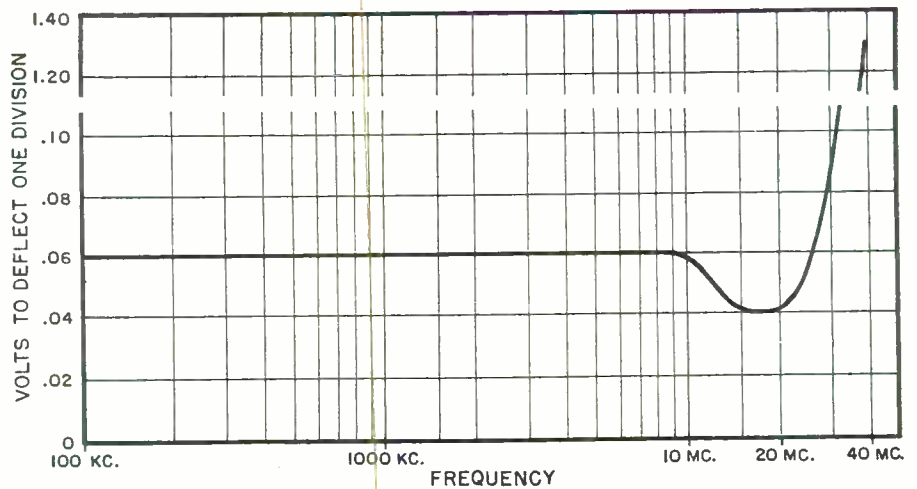

Fig. 3. Curve shows the sensitivity of the probe at radio frequencies.

of a grid leak vacuum tube voltmeter and a single stage of audio amplification. The detector circuit consists of a 1T4 tube connected as a triode, with a .0002  $\mu$ fd. coupling condenser and a 20 megohm grid resistor. The input impedance of the grid circuit is so high that there is no loading of the circuit under test at any frequencies below 10 mc.

A switch in the plate circuit provides for operation of the tube as either a vacuum tube voltmeter or an audio amplifier stage. The operation of the vacuum tube voltmeter may be described briefly as follows: When there is no signal applied to the grid, current flows in the plate circuit because there is no bias on the grid. When a signal is applied to the grid, rectification takes place and the current flowing through the grid resistor biases the tube, causing the plate current to drop. In order to make the meter give positive current readings for decreases in tube plate current, the meter is connected in reverse (plus

terminal to plate, and minus to B+) and a bucking voltage applied across the meter to bring the reading to zero when there is no signal. Meter current is adjusted to zero for no signal by means of the 500 ohm balancing potentiometer. Then, when a signal is applied to the grid, the meter reads up scale in the conventional manner. It may be mentioned that the calibration is not in volts, but in relative signal strength, and that the meter used in this circuit is the new cobalt magnet type, which is much more rugged for portable use.

With the switch in the "Speaker" position, the 1T4 serves as a stage of audio amplification which drives the 3S4 in a high gain stage operating the speaker. An Alnico V speaker is used because of the greater sensitivity it offers. In addition to the speaker, a phone jack is provided for the use of phones when greater sensitivity is required, especially if a weak signal is being checked. The phone jack is of

(Continued on page 86)

Fig. 4. Schematic diagram of visual-aural signal tracer.

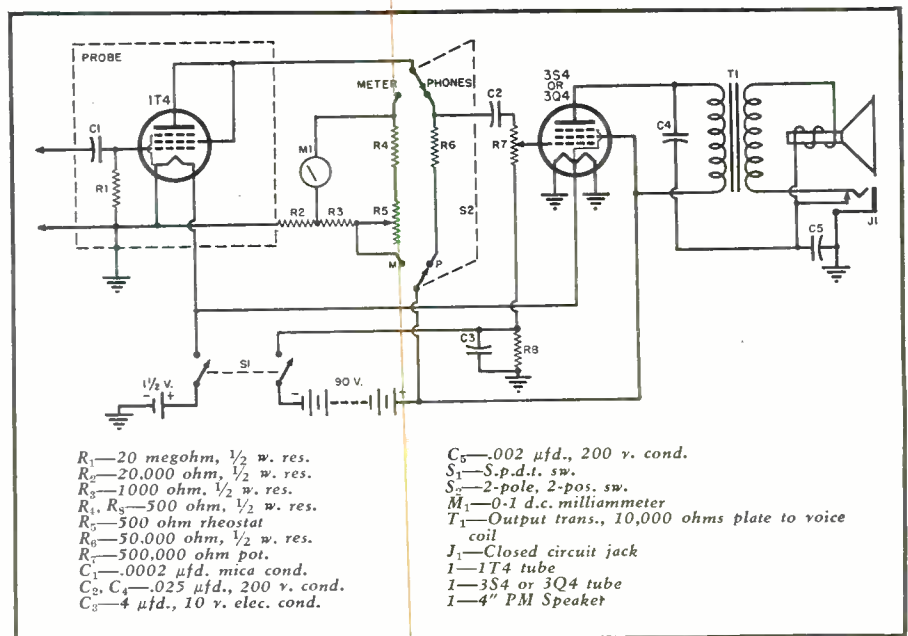



Fig. 1. Both visual and aural indications are provided in this battery-operated test unit.



# A New All-Purpose SIGNAL TRACER

By SHEPHARD LITT

Design Eng., Superior Instruments Co.

**Construction details of a commercially built test instrument. Radio receiver faults can be quickly and accurately located with this signal tracer.**

FOR some time now it has been generally conceded by progressive radio servicemen that the principle of signal tracing is, in general, the simplest and most direct approach to the problem of diagnosing the defects in radio receivers. The reason for this is that the signal tracing method makes use of the most fundamental factor in any type of electronic system—the signal itself. Guessing at the trouble, on the basis of previous experience with similar difficulties, is unreliable and does not keep pace with the continued development in communication circuits. The point-by-point system of static voltage and current measurement by means of a multirange volt-ohm-milliammeter is very slow and not completely dependable, since any number of defects may exist in the system without in any way altering the operating potentials or d.c. resistance values. The method of signal tracing, by which a signal is applied to the input and traced stage-by-stage through the receiver under operating conditions, offers the advantages of superior speed, universal application, and positive identification of the defects.

Fig. 2. Audio frequency response of the v.t.v.m. showing the voltage required for full-scale deflection.

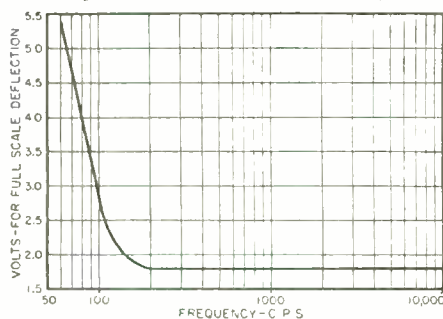

The only major objections now raised against the use of signal tracing in the servicing of receivers concern the amount of equipment which must be carried, and the possible adverse psychological effect which may be given to the customer by the radio serviceman who needs a considerable amount of test equipment to diagnose what may be a simple defect in the receiver. The merit of this criticism is evidenced by the continual simplification in the design and construction of signal tracers. In the research laboratory, signal tracing in newly designed equipment is generally performed by the use of the vacuum tube voltmeter, the oscilloscope, and the distortion meter. It would obviously be ridiculous for a radio repairman to carry all this equipment into a customer's living room to diagnose the trouble in a radio receiver. Furthermore, the average repairman does not like to use an oscilloscope, and has no need for a distortion meter. He would prefer to listen to the audio signal for quality and distortion rather than see it on the screen of an oscilloscope or on a distortion meter. Signal tracers for radio receiver servicing therefore have become small, compact, easily portable instruments performing one or more functions to simplify as much as possible the tracing of the signal through every section of the receiver.

The signal tracer described in this article is an improved model which provides an r.f., i.f. and a.f. vacuum

tube voltmeter, and at the same time offers an audible check of the signal quality by means of a loudspeaker or earphones, thus permitting maximum flexibility with increased sensitivity. With the use of this signal tracer, a volt-ohm-milliammeter and a spare set of good tubes, the faults in a receiver can be rapidly and completely diagnosed (in the customer's home, if necessary) without the use of any additional equipment. It is, of course, desirable to have available a modulated r.f. signal generator and a tube tester when the receiver is being serviced in the shop, but on occasions when work must be done outside of the shop it is a decided advantage to be able to carry as little equipment as possible.

A number of different signal tracers are in general use at the present time, but most of these possess certain limitations either to their application or to their ease of operation. The signal tracer described here possesses a number of decided advantages over other existing instruments of this type:

a. Most of the available instruments possess either aural or visual indication of the signal, but not both. In those which do give both, a 6E5 "magic-eye" electron-ray indicator tube is generally used as the visual indicating element, thus giving either very approximate readings, or necessitating continual setting of a gain control with the closing of the eye as a reference each time an accurate voltage



# Experimental U.H.F. OSCILLATOR

By C. W. ROESCHKE, W9PFB

**Constructed from available parts, this simple u.h.f. oscillator will cover the range from 400 to 800 megacycles.**

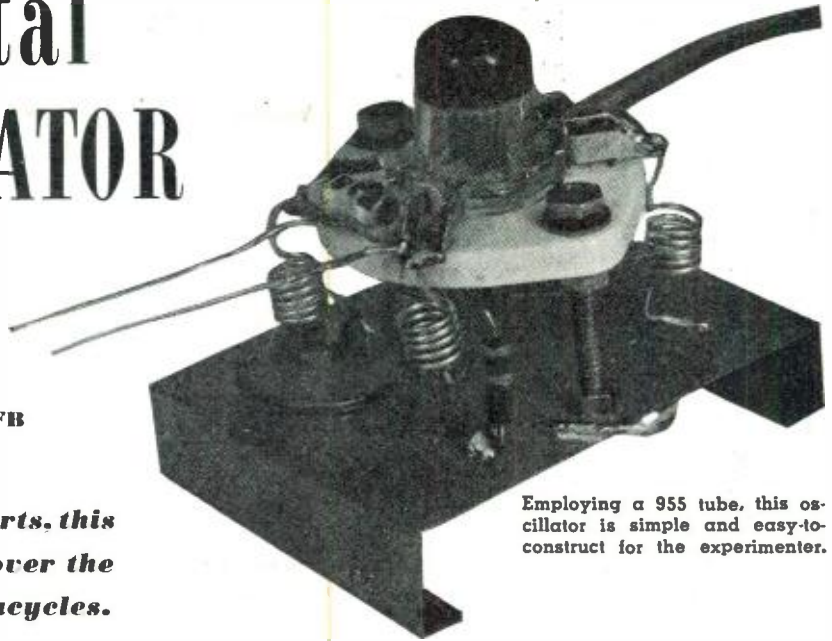

Employing a 955 tube, this oscillator is simple and easy to construct for the experimenter.

**H**ERE is a u.h.f. oscillator which can be constructed in an hour without the assistance of a plumber or a machinist. It consists of a very few components, most of which can be made by hand in a few minutes.

Fig. 1 shows the circuit diagram of the 400 to 800 mc. oscillator. The frequency of this oscillator depends on the position of condenser,  $C_1$ , along the line  $L_1$ . This circuit is based on D. B. Sinclair's development described in his article entitled "High Frequency Measurements." This article originally appeared in the January, 1946, issue of the RADIO-ELECTRONIC ENGINEERING edition of RADIO NEWS.

Fig. 2A shows how the r.f. chokes (RFC) are made. All four are identical and consist of 5 turns of No. 22 wire with  $3/16$ " inside diameter and a winding length of  $9/32$ " or  $5/16$ ".

Fig. 2B describes the construction of the feed-through condenser. It is necessary to use this type of condenser because "postage stamp" type mica condensers frequently introduce too much inductance in the circuits. Of course, commercially manufactured feed-through condensers may be used and the required capacity would be about  $50 \mu\text{mfd}$ . As shown in the drawing, the feed-through condenser is made up of the following parts: (A)  $6-32 \times 1/2$ " screw, (B) lockwasher, (C) solder lugs, (D) copper washers,  $1/16$ " thick  $\times 3/8$ " diameter, with a  $3/16$ " hole in center, (E) mica washers,  $.010$ " thick  $\times 3/8$ " diameter, with  $3/16$ " hole in center, (F) spaghetti sleeving  $3/16$ " long to fit over screw, (G) plain washer, (H)  $6-32$  nut.

As can be seen in the photograph, the r.f. chokes are mounted in a perpendicular position. They project straight down from the tube terminals to the chassis. This is important as leads must be short. The tube socket is only  $3/8$ " above the chassis.

The dimensions and mechanical layout for constructing the chassis are shown in Fig. 4.

A common lead for "A—" and "B—" is soldered to the chassis near the point where the grid resistor is also grounded.

Leads on the ceramic condenser are about  $1/8$ " long and the condenser is soldered across the parallel lines. Tinned wire of size No. 20 is used to make the tuned line,  $L_1$ , which is connected between plate and grid of the

tube. The line is  $2 1/2$ " long with a  $3/8$ " spacing between the wires.

Filament voltage can be 6 volts, either a.c. or d.c.

300 volts d.c. should be used on the plate as the circuit will not oscillate dependably if a voltage of much lower value is employed.

First apply filament voltage and allow the tube to heat. Then apply plate voltage and the circuit will oscillate. It is as simple as that. There

(Continued on page 116)

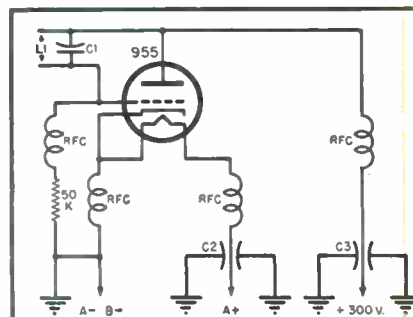

$C_1$ —50-100  $\mu\text{mfd}$ . ceramic cond.  
 $C_2, C_3$ —Feed-through cond. (See text)  
 $L_1$ —Tuned line (See text)  
RFC—R.f. chokes (See text)

Fig. 1

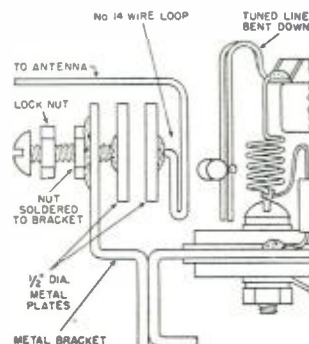

Fig. 3

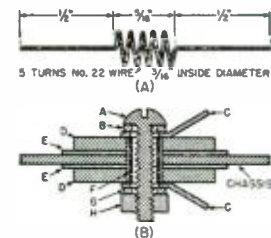

Fig. 2

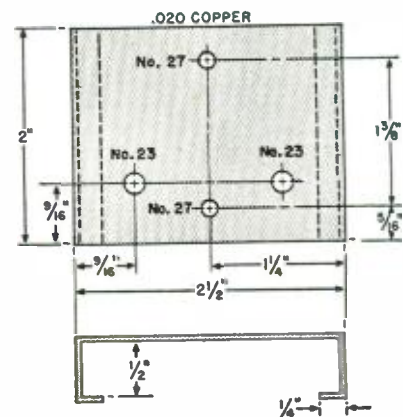
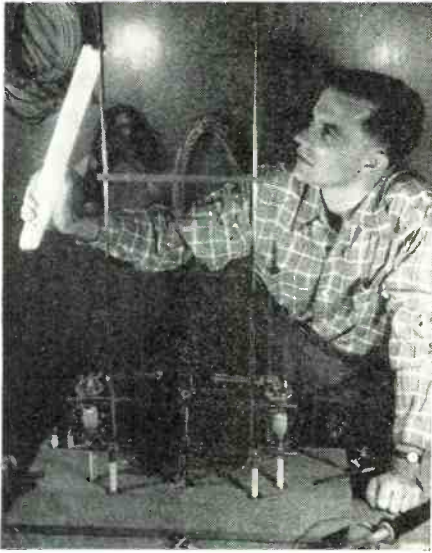

Fig. 4





Fluorescent tube indicates presence of r.f.

bright cherry red. This is a bit unusual for a tube with a carbon anode but the GL-592 has been treated in such a way that no gas is released when the anode is operated at these very high temperatures.

The final circuit adjustment should normally be to test for the presence of r.f. at the center of the grid and plate lines. If there is any r.f. indicated by a neon bulb at these points the fuse clips should be moved one

Closeup view shows details of complete assembly. Note in particular the mechanical symmetry of the construction. This is important and should be closely followed. The two GL-592 tubes have been mounted with the anode terminals down. This was done in order to provide a mechanical means of supporting the tube.

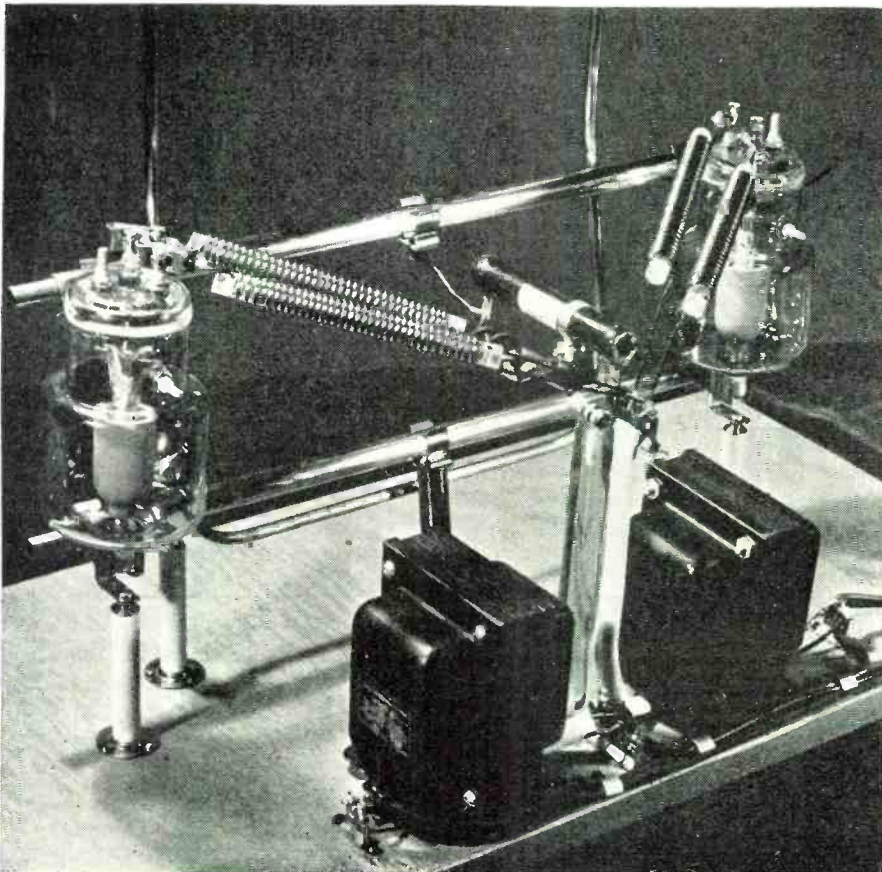

way or the other until the electrical center has been located.

Frequency changing could have been accomplished by shunting the grid and plate of each tube by a disc-type neutralizing capacitor. The authors felt that this would mean needless expense and so decided to use the tuning slugs indicated in the circuit diagram. These tuning slugs are made of copper tubing which is of the proper diameter to give a slide-fit inside the one-half inch diameter grid and plate lines. Each slug is two inches long. If all dimensions are carefully followed it should be possible to tune over the entire 2-meter band by sliding the four tuning slugs in or out of the grid and plate lines. If the frequency is found to be too high with the tuning slugs most of the way out it will be necessary, of course, to make the tuning slugs longer. A change in the antenna coupling will be reflected in a change in oscillator tuning so that it is necessary to readjust the tuning slugs whenever the antenna loading is changed.

#### Antenna

Transmission lines used on the high-frequency bands are sometimes the cause of very strange results. For that reason the decision was made to forego completely a transmission line and to couple the antenna directly to the tank circuit. The antenna shown is a result of this thinking. When it

became apparent that it would be necessary to couple over a great percentage of the plate line the authors decided to come straight out from the coupling loop with a pair of half-wave vertical elements spaced  $\frac{1}{8}$  wavelength apart. The result is an end-fire array with a gain of 4.3 decibels. The pattern of this antenna when checked with a field-strength meter was found to be very close to the theoretical.

The combination antenna, transmission-line and coupling loop is made up from one piece of  $\frac{3}{16}$ -inch diameter copper tubing. The spacing between adjacent half-waves is ten inches, center-to-center. Total height of antenna is 42½ inches. A rod of one-half inch diameter polystyrene, twelve inches long is drilled out to pass the three-sixteenths inch tubing and is then placed on the antenna system twenty-one inches from the top. The rod is required for mechanical strength and adds no loss as it is placed at a voltage node (point of minimum voltage).

The antenna system is supported on two, three-inch insulators, and fastened to them by means of a clamp. Antenna loading may be changed by adjusting the position of the bottom portion of the antenna system with respect to the plate line. As the photograph shows it is necessary to bend the two half-wave lines in order to clear the grid line.

In some cases it may be desirable to use an antenna remote from the transmitter. If this is the case, a regular open-wire or coaxial transmission line may be used. The pickup loop should be coupled to the plate line only. The size of the coupling loop will depend on the loading desired.

#### Results

In a series of tests made with this rig on the air, it was very difficult to tell what effect the beam had as all of the stations contacted were using superregenerative receivers. On one contact, however, an interesting experiment was made. While W6OJK/2 was in contact with W7BBI/2, George asked the op at W7BBI/2 how much hiss was still present in his receiver. When it was learned that there was no hiss present W7BBI/2 was requested to reduce his antenna coupling until some hiss was present in order that a signal strength comparison could be obtained. After much fussing W7BBI/2 came back and said that he was sorry but with the antenna on his receiver decoupled as far as possible, there was still no hiss in his receiver when receiving W6OJK's carrier.

At first thought it might seem that a modulated oscillator with a kilowatt of power might put out an extremely broad signal. This, however, did not seem to be the case and in one direct comparison against another 20-watt carrier the kilowatt carrier covered five divisions on W7BBI's receiver as compared to four divisions for a 20-watt carrier which was being received over approximately the same distance.



ent rating of the tube is a top frequency limit of only 110 megacycles for full output, tests are now in process to determine how high in frequency the limit may be extended. It is necessary with the GL-592 to use a slight amount of air cooling which is easily provided by a small 10-inch fan. The fan should be placed at an angle to the unit so that air is directed at both tubes.

### Constructional Details

The circuit is so simple that the majority of the details can be seen from the photograph. It is extremely important to maintain mechanical symmetry. This was even carried to the point of using two identical filament transformers. This is perhaps carrying the symmetry idea too far but a ten-volt, ten-ampere filament transformer was a little difficult to find so two ten-volt, five-ampere transformers were used.

For purposes of support the tubes are mounted with the anode caps down. The anode support proper consists of two thirty-ampere fuse clips placed back to back with a one inch angle held between them by means of a machine screw. One of the fuse clips fastens to the half-inch copper tubing of the plate line and the other grips the anode cap of the GL-592. The other end of the 90 degree angle fastens to a three-inch insulator which supports the entire assembly.

The grid line is supported on the grids of the tubes themselves, connections being made to the grid line by a thirty-ampere fuse clip which is in turn fastened to a Fahnestock clip which clips over the grid lead. Fahnestock clips are similarly used for filament connections.

Thirty-ampere fuse clips are also used to connect the plate choke to the center of the plate line and to connect the grid resistor to the center of the grid line. A six-inch insulating pillar at the rear of the unit acts as a tie point for the filament and grid return circuits. A three-terminal tie strip is fastened at the top of the insulator. The filament leads and the filament center tap run to this point from the transformer tie strip located between the transformers. The grid resistor connects to the filament center-tap at the tie-point mounted on the six-inch insulator.

### Operating Adjustments

The particular unit shown in the pictures oscillated the first time it was tried. Subsequent testing convinced the authors that only an order from the FCC would stop the oscillations. Very few of the parts were found to be critical, but minor adjustments should be made in order to achieve optimum efficiency.

The filament chokes constitute the only part of the circuit that may require any changes at all but the chokes shown in the diagram should work very satisfactorily. The authors found that it was possible to short out

## TYPE GL-592 PLIOTRON TRANSMITTING TUBE

This new tube has been designed for use in amateur radio and industrial applications which require power in higher frequency ranges. It is a three-electrode tube designed for use as an amplifier, oscillator, or class B modulator. The anode is capable of dissipating 200 watts for CCS and 300 watts for ICAS conditions. Forced air cooling of the envelope is required. Maximum ratings apply up to 110 mc. For ICAS class C telephony operation, maximum ratings are: d.c. plate voltage, 3000; d.c. grid voltage, -500; d.c. plate current, 250 ma.; d.c. grid current, 100 ma.; plate input, 750 watts; plate dissipation, 225 watts.

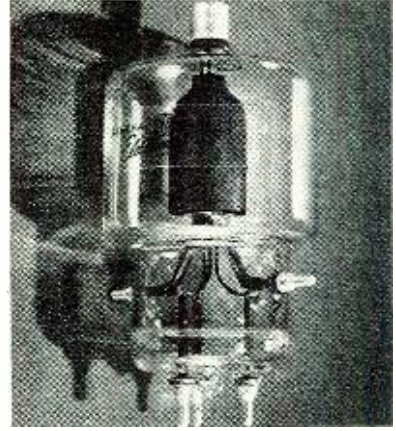

Electrical specifications of General Electric's GL-592 tube.

the r.f. choke in the plate circuit without any ill effects whatsoever on the operation of the circuit. It was kept in, however, to be on the safe side. The 100-ohm resistor was included in the grid circuit in order to measure the grid current. In use, the grid meter is merely placed in parallel with the 100-ohm resistor. One precaution may be in order at this point. When measuring either grid or plate current do not leave the meters in the circuit any longer than is necessary because the terrific radio-frequency field in the vicinity of this oscillator is liable to burn out the meters. The transmitter and antenna coupling should be ad-

justed so that the GL-592 tubes draw 0.400 ampere at 2500 volts. The grid current (for both tubes) should not exceed 0.100 ampere but should be kept as high as possible. The grid current ran 0.090 ampere in the unit described, with 2250-ohms resistance in the grid circuit.

Tests showed that the transmitter produced less frequency-modulation when the grid drive was high than when the tubes were not driven hard. For this reason it is recommended that the grid current be kept above 0.080 ampere.

Under normal operating conditions the anode of the GL-592 tube runs a

Schematic diagram of 2-meter rig. Two high frequency type GL-592 triodes are used. Although manufacturer's rating for top frequency limit is shown as 110 mc., the authors were successful in obtaining satisfactory operation of these tubes in 2-meter band (144-148 mc.).

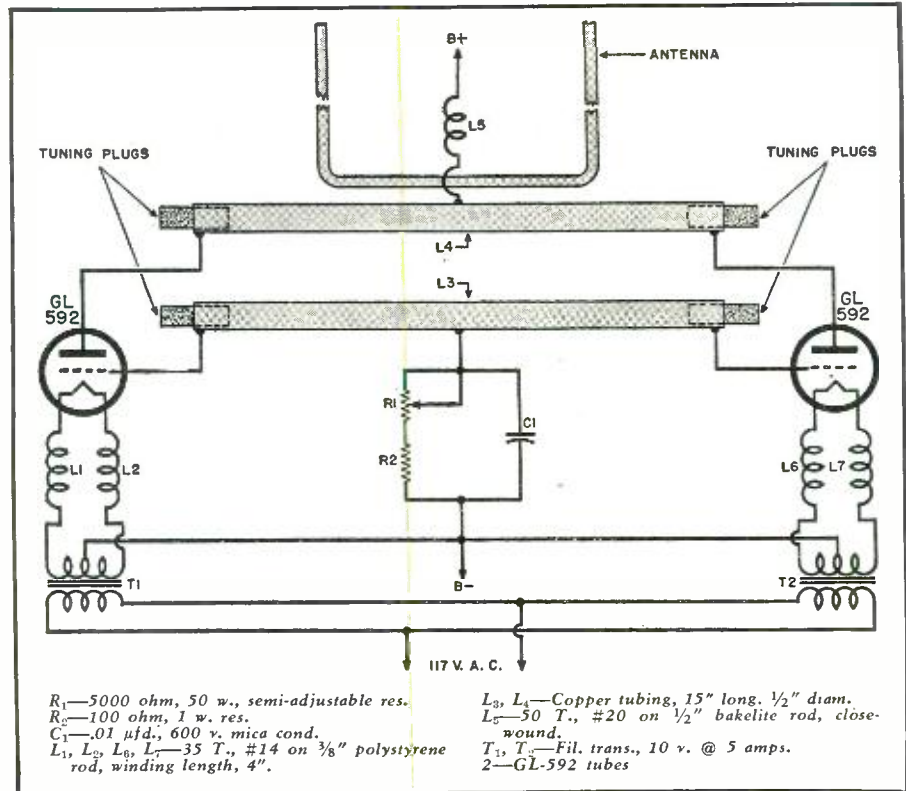



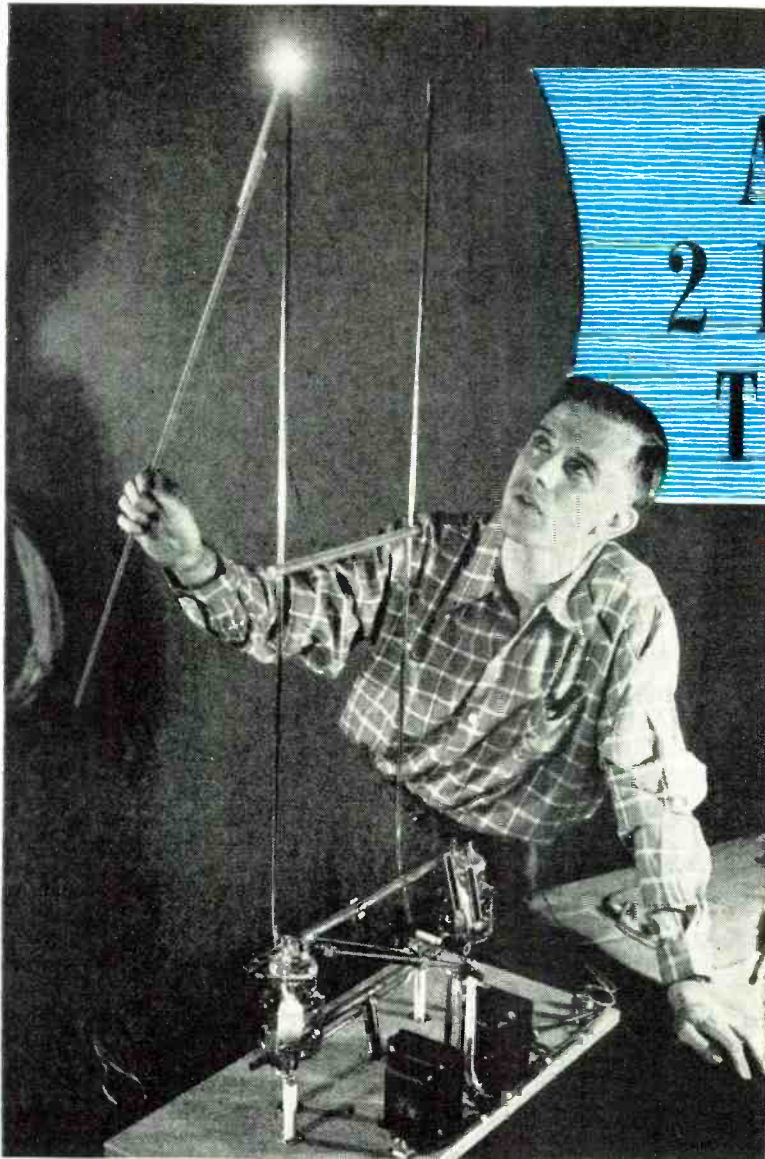

# A Breadboard 2 Meter Kilowatt TRANSMITTER

By

**G. H. FLOYD, W2RYT**

and

**H. D. WELLS, W8LWD**

Tube Div., General Electric Co.

***This experimental 2-meter rig, using new h.f. triodes, can be built at relatively low cost by the amateur.***

Operator is shown checking r.f. performance of transmitter. Note that the antenna in this construction is coupled directly to the tank circuit. A regular open-wire, or coaxial transmission line may be used should a remotely placed antenna be desired.

**I**S THERE some simple and inexpensive way to get on 2 meters? The question assumes importance when one considers how many of us there are who are "planning to go on 2 meters sometimes," but who never quite achieve this end. It is usually not possible to wind a few new coils for your present rig, stick up another piece of wire as an antenna and go on any of the high-frequency bands.

Here, however, is a simple and inexpensive way to get on 2-meters—a bread-board 2-meter kilowatt.

The desirability of a simple rig immediately ruled out both a crystal-controlled or an m.o.p.a. transmitter. This leaves only a modulated oscillator. The authors, although they agree that a modulated oscillator is not too desirable, believe that it is better to be on a band with a properly adjusted modulated oscillator than not to be on at all.

The question of what type of mod-

ulated oscillator to use provoked much thought. From the standpoint of efficiency a resonant-line oscillator is to be preferred because a high impedance circuit and a relatively high-Q tank circuit can be achieved. Further, these circuits have large physical size in proportion to the wavelength. Because it offered so many advantages the so-called "teeter-totter" high-frequency oscillator circuit was finally selected. This circuit has the advantage over most resonant-line circuits in that two tubes are used, thus giving a completely balanced layout and eliminating the shorting capacitors which would be necessary, as well as the short circuits present, if a one-tube resonant-line oscillator circuit were used.

Reference to the circuit diagram shows two triodes placed at opposite ends of a foreshortened, 300-ohm, half-wavelength line. The filaments are isolated from ground by radio fre-

quency chokes and the addition of a plate choke and grid resistor completes the circuit.

One advantage of the "teeter-totter" oscillator circuit is that there is no feedback adjustment to make as the grid and plate voltages are automatically maintained 180 degrees out-of-phase due to the location of the tubes on the transmission line. Another important advantage is that the ground circuit is not tricky. There are actually three points in the circuit at r.f. ground; the center of the plate and grid lines, and the r.f. electrical center of the filament circuit. There is no difficulty with length of leads in ground circuits and if it is found to be necessary to connect to ground the connection should be made at the "B minus" point.

In order to obtain optimum results with a "teeter-totter" circuit it is necessary to use high-frequency tubes. The new *General Electric* GL-592 seems to fill the bill very nicely. Although at first glance it might seem strange that a tube of this power capability was selected, it worked in quite nicely with the authors' plans to use the power supply and modulator from the present rigs. A pair of GL-592 tubes was found to be capable of handling an input of 1 kilowatt for 2-meter phone work. Although the pres-

**RADIO NEWS**



**The author discusses several important factors which must be taken into consideration when you select the new location for your radio business.**

By **SAMUEL C. MILBOURNE**

**L**ET us suppose, for a minute, that you are either going to open a radio service business or are going to move your existing shop to another location. By what signs can you recognize the "perfect" site for your shop? How can you be sure to choose the *most profitable* location?

First, let us understand that—as in many other things—what is one man's jewel becomes another man's millstone. If, for instance, you were to engage in a "wholesale" repair business, that is, do work exclusively for other radio dealers and servicemen, there would be absolutely no need for a "fancy" store front on or near a main street. A loft, or other cheap but commodious floor space, centrally located with respect to your dealers would be your answer.

Second, if you do not do sufficient radio service work to support even a small store on a side street, your logical step is to do your radio service work in the basement or in a spare room of your home until you can build up a clientele. Many servicemen make a satisfactory living operating from their homes, and with a minimum of expense.

However, there comes a time when space becomes cramped, business becomes greater, and more advantageous quarters become a necessity.

The proper operation of a store involves certain responsibilities that will take a definite part of your time which, heretofore, may have been spent solely on radio servicing. The store must be kept neat, the windows must be dressed periodically, there must be someone in the store during the *complete* business day (even when you go out on a call), and there will be a constant flow of floor traffic (for that is the purpose of a store) which will interrupt your actual bench work. If you can not handle these problems, don't open a shop.

Let us assume that the above conditions have been met and that you are going to sally forth in quest of a shop location. How do you go about it?

First, you must be familiar with your town or city. You should know its busy streets and its byways. This should be no problem to a wide-awake radio serviceman who specializes in serving his city. On your calls, keep your eyes open for empty stores. Copy the real estate agent's name and address and, in each case, inquire from him as to the rent and facilities of the site. By all means do not take the first or second store which you see. If you do, you will almost surely get less than you really want and should

have. First get a solid basis and understanding for comparing store values *in your town*. Compare such items as (1) rent, (2) floor size, (3) type and condition of building, (4) type and condition of store front and windows, (5) shape and condition of interior, (6) location and condition of any store fixtures, and (7) the approximate cost of fixing it up for your use.

If you are operating in a large city, and you are to confine yourself to one neighborhood, give due consideration to the location of your new shop as it relates to the district you wish to serve, that is, try to locate near the center of your customer area.

Keep a list of these store locations as they come up, and you will soon see at least one case where almost identical stores (as far as store values which we have so far given) will have a variation in rent between them as much as 300% to 500%. While there is always the chance of a "bargain," store values are like everything else—you get only what you pay for. It is the smart serviceman who can size up a store location and can see additional points of superiority which make that *particular* spot more advantageous to him than to some one else in another line of business.

Here are some of the things to look for in choosing a store for your radio business.

1. Proximity to other stores, particularly drug, grocery, meat, delicatessen, frozen food, hardware and department stores; banks, public buildings, and other service institutions; gas, electric, water and telephone offices where people pay their bills; restaurants, theaters, lunchrooms, soda fountains and stationery stores; businesses where the customer delivers and picks up his own things—such as self-service laundries, dry cleaners, etc.; chain stores of any type; professional men's and women's establishments such as doctors', dentists' and lawyers' offices, and beauty shops; business establishments such as manufacturing plants which employ large numbers of people.

Note that in each of the above cases, these types of businesses mean a flow of street traffic. It is your object to obtain a location which will catch the maximum amount of this traffic, either (1) passing your shop, (2) across the street from it, or (3) just around the corner from it. The preference of location is in the order just named.

If you are interested in auto-radio repairs, note the proximity of auto

dealers, garages, parking lots and auto supply stores.

Another point to consider in auto radio servicing is to plan for sufficient space so that cars can be driven under a roof for ease of servicing and for the customer's comfort.

If you are interested in the farm trade, watch for feed and grain stores, seed stores, farm implement stores and for stores selling farm-size deep freezers.

If you were checking locations for a large chain company, among other things you would do would be to actually count the flow of traffic past the site. You might find that the early morning traffic was made up of office and factory workers on the way to work, but that these same people homeward bound in the afternoon used the other side of the street because it was the shady side. People going to work have little time for shopping. Locate on the side of the street where workers walk, homeward bound.

A knowledge of the *type* of people making up the traffic flow is important. For instance, if you want to sell records, a large percentage of popular records are sold to the "teenagers." Thus, if you locate in the "path" of a school, public library or "Sugar Bowl," you are sure to get the teen-age traffic past your store.

Another point to check is whether or not the store is close to a stop on a street car, bus or subway line. People have to wait for such transportation and while they wait, they "scan" the neighboring store windows and signs. Being close to such a stop is important if your window display or sign is close enough to be seen clearly.

If the stop is a "transfer" point on a car or bus line, or an express stop on a subway, it is an even better location. Once more, such conditions encourage pedestrian traffic and the more flows past your shop, the more chance there is for repair sales. Remember, however, that the better the location, the higher the rent, and that radio repairs alone will not produce top store rents.

A word about store entrances with relation to attracting customers. Most stores have their floors on a level with the street. However, every now and then, you will run across a store with a step or steps in front. The store floor level will be above or below the street level. My personal recommendation is to steer clear of *all* "off-street-level" stores, no matter how "cheap" the rent might be. People just will not walk up or down steps if they can help it—but they will climb down rather than up. Many a small business venture has been tripped by just one step.

There are certain specialty repair services which require special locations. For instance, if you wish to specialize in airborne electronic equipment repair, you should locate at an airport or airfield. Likewise, if

(Continued on page 132)



# YOUR SHOP LOCATION



This is an ideal location for a store from the standpoint of pedestrian and car borne traffic. A more spectacular store front, improved lighting and the use of signs could increase sales.



In selecting the location for your store avoid premises where the customer must climb stairs or step down. This factor is a great deterrent to business, inconsequential though it may seem.

A transfer point is a good selling location, particularly for "impulse items." To make this a good service location, pickup and delivery of the radios to be repaired must be provided.



Avoid dead-end streets in residential areas unless you are a dynamic merchandiser and can overcome the many obstacles which this type of location will put in the way of your success.





quency modulation produced by the reactance tube  $V_3$ . The amount of frequency modulation produced by the reactance tube may be made equal to the spurious frequency modulation by adjustment of the setting of the potentiometer  $R_6$ , and may be made to either aid or oppose the spurious frequency modulation by proper setting of the reversing switch. The setting of the switch must be determined by experiment, for the reactive changes introduced by the amplitude modulation of the anode circuit of the oscillator tube may be either capacitive or inductive, depending upon the mode of operation of the particular oscillator circuit used. By experiment it is possible, therefore, to set both the reversing switch and the potentiometer so that there are no frequency modulated components present in the output of the modulated oscillator.

If the oscillator is being used as a signal generator to align or calibrate a receiver, the potentiometer and the reversing switch may be set by adjusting for the minimum "width" of the generated signal on the tuning or aligning control of the receiver under test. This position may be determined very rapidly when the user has become accustomed to the "feel" of the controls. The use of a cathode-ray oscillograph to set the controls is, of course, the quickest and simplest method.

In addition to its use in stabilizing signal generators, test oscillators, and the like, the above-described scheme has proved very worthwhile in reducing the bandwidth of the 144 mc. amateur transmitter at W11IN. All stations worked report that our signal is as sharp as the best of the crystal-controlled transmitters.

Referring now to Fig. 2, it will be seen that a push-pull TNT oscillator using an 832 dual beam tetrode, is connected in the conventional manner to a 6V6 modulator through a conventional modulation transformer  $T_1$ . The 6V6 modulator is driven in the normal manner by a carbon microphone through a microphone transformer  $T_2$ . The reactance tube frequency modulator comprising a 6SJ7 pentode, is coupled to the untuned grid coil assembly  $L_4, L_6$  by means of a third winding,  $L_5$ , connected between the two halves of the grid coil. Coils  $L_4$  and  $L_6$  are each wound on a form one quarter inch in diameter and consist of 3 turns each of #14 tinned, spaced about the diameter of the wire. The spacing between turns is adjusted to provide feed-back at the desired output frequency. The coil  $L_5$  comprises 10 turns of fine wire one quarter inch i.d. wound on a polystyrene rod which is supported by the coils  $L_4$  and  $L_6$ .  $L_1$  and  $L_3$  each consist of 2 turns of No. 10 wire  $\frac{1}{2}$ " inside diameter with spacing the diameter of the wire, and  $\frac{1}{2}$ " between coils.  $L_2$  is 2 turns of the same size, mounted between  $L_1$  and  $L_3$ . The values of the various circuit components associated with the 6SJ7 reactance tube, were determined experimentally and may have to be changed if widely different

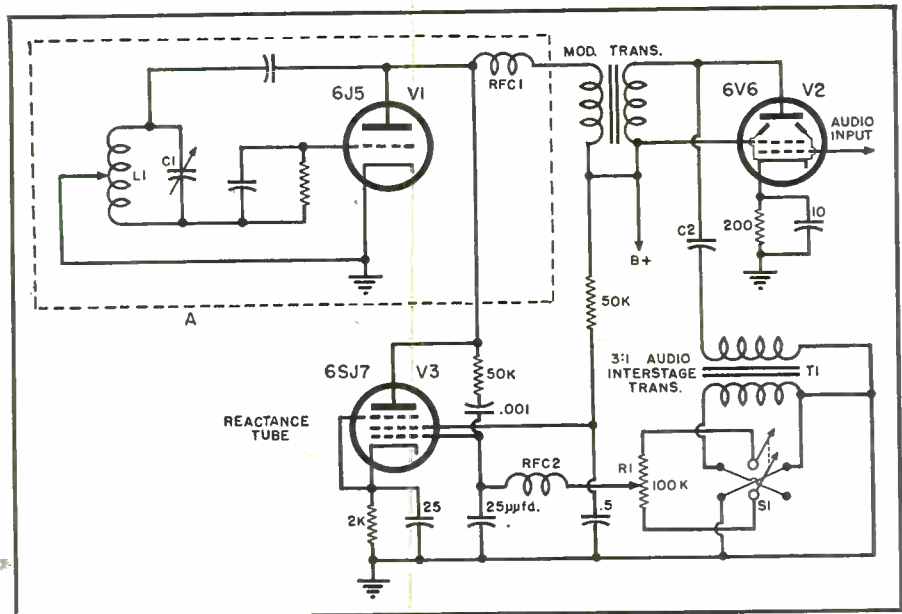

Fig. 1. Schematic diagram of stabilized modulated oscillator. Section enclosed within dotted lines is conventional Hartley oscillator circuit.

lay-outs of components are used. The values indicated in the circuit diagram, however, will probably be satisfactory in most instances.

It can not be over-emphasized that the extremely high operating frequency of the system shown, introduces problems of reactance tube design not met with in conventional arrangements.

The gain control  $R_6$  connected in the grid circuit of the 6SJ7, is used to adjust the "counter deviation" until it exactly matches the deviation caused

incidentally by the 6V6 amplitude modulator. This gain control  $R_6$  will probably have to be readjusted with changes in the setting of the audio gain control  $R_5$ .

The remainder of the circuit is conventional in all respects and the values indicated in the parts list will be found to be generally satisfactory.

The writer wishes to express his appreciation to Mr. R. C. Merryman, W3FBB, for his invaluable assistance in the construction and testing of the model illustrated.

-30-

Fig. 2. Schematic diagram of a practical transmitter which incorporates a stabilized modulated oscillator replacing conventional crystal control.

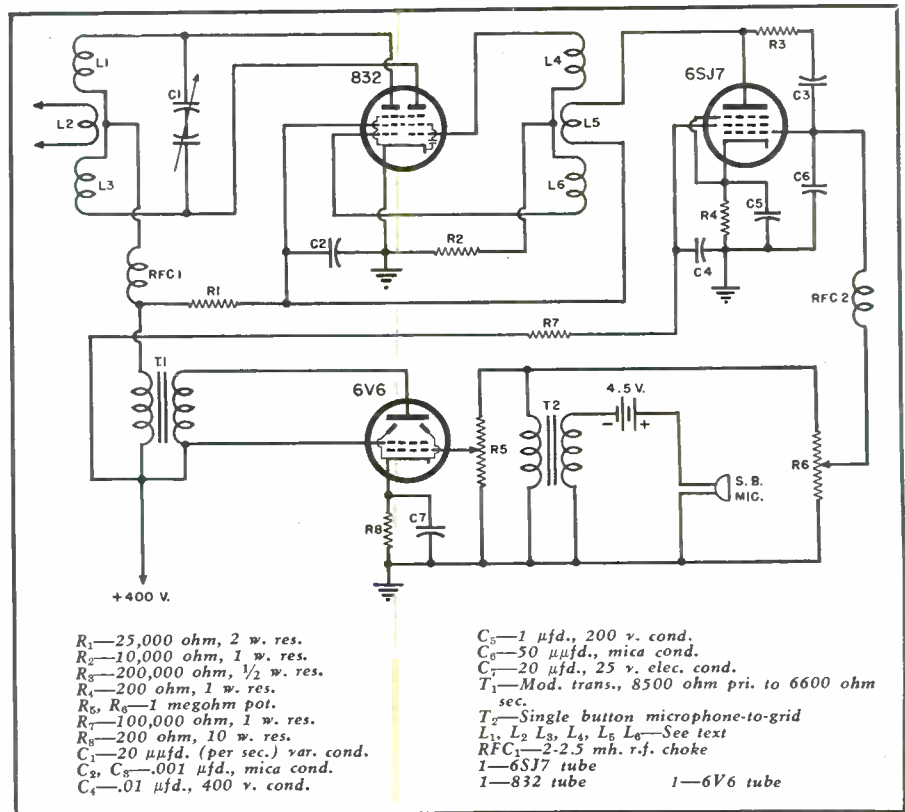



here's  
the meter  
they're all  
talking  
about

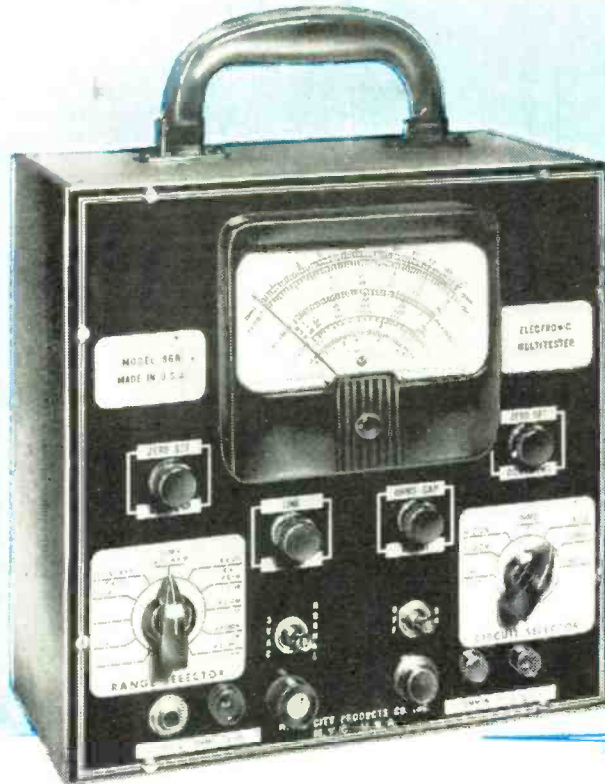

AC-DC VACUUM-TUBE  
VOLT-OHM-CAPACITY  
METER Model 668



## THE METER THAT BRINGS LABORATORY STANDARDS TO YOUR SHOP

Yes, this is the meter that was always "just around the corner". But now it's here—and brother, it has *everything*.

Laboratory precision—broad versatility—amazing economy—and the ruggedness and dependability for which RCP instruments have long been noted.

Model 668's comprehensive scope and accuracy will

help you to solve your toughest trouble-shooting problem. And with voltage, resistance, and capacity meters in a single unit you can speed up your service jobs—step up your profits.

Ask to see this remarkable instrument next time you visit your jobber. Dollar for dollar, it out-performs every other instrument in the field.

### Model 668 features

- The only unit with a vacuum-tube voltmeter available which measures to 6,000 volts AC and DC.
- Meter provided with both mechanical and electrical zero adjustment.
- Exclusive RCP circuit design eliminates all errors due to line-voltage fluctuations and gives RMS measurement values.
- Ohmmeter battery check under load conditions assures maximum accuracy.
- Model 668 is a vacuum-tube voltmeter that is also a vacuum-tube capacity meter.
- Vacuum-tube voltmeter measures signal and output voltages from 10 to 250,000 cps. at even the highest values.
- Meter cannot be damaged by using the low range on a high-voltage reading.
- D-C voltmeter readings can be taken without affecting the constants of circuits under test.



### Ranges

**A-C VACUUM-TUBE VOLTMETER:**—(Direct reading) Input capacity of 0.00005 mfd at terminals of instrument. Input resistance of 160 megohms on 1,500 and 6,000 volts and 16 megohms on low ranges.—Seven ranges: 0/3/6/30/150/600/1,500/6,000 volts.

**D-C VACUUM-TUBE VOLTMETER:**—(Direct reading) Sensitivity of 160 megohms on 1,500 and 6,000 volts and 16 megohms on low ranges.—Six ranges: 0/6/30/150/600/1,500/6,000 volts.

**VACUUM-TUBE OHMMETER:**—(Direct reading) from 0.1 ohm to 1,000 megohms. Seven ranges: 0/1,000/10,000/100,000 ohms; 0/1/10/100/1,000 megohms.

**CAPACITY METER:**—Measures from 0.00005 to 2,000 mfd.—Seven ranges: 0/0.002/0.02/0.2/2/20/200/2,000 mfd.

**RCP INSTRUMENTS—BEST FOR EVERY TEST**

**RADIO CITY PRODUCTS COMPANY, INC.**

127 WEST 26th STREET



NEW YORK 1, N. Y.



## RC Oscillator

(Continued from page 47)

paralleling two sections, it is possible to vary the range in excess of ten to one (150 to 1500 cycles).

By addition of three separate sets of  $R_1$  and  $R_2$  resistors and switching, three ranges are created: 15 to 150 cycles; 150 to 1500 cycles; 1500 to 15,000 cycles. When such ranges of frequencies are covered, phase shift becomes important. If phase shift is eliminated, a calibration for one set of resistors will remain constant on the other ranges if the resistors are identical in pairs and vary in a ratio of ten to one, such as 100,000 ohms, 1 megohm and 10 megohms, providing the resistors have close tolerances. A 1% resistance error will create the same percentage of frequency error.

If phase shift occurs, the calibration for each set of resistors will not be linear. This condition is indicated by the fact that the ranges follow the calibration for a portion of the dial and become in error toward the high frequency end of the calibration. Too low a value of capacity used in either  $C_1$  or  $C_2$  will create phase shift at low frequencies. Circuit wiring and the use of parts that have capacity to ground will cause the high frequency calibration to vary.

The oscillator voltage can be obtained from two points, the cathode

of the 6G6 or the plate of the 6G6. Approximately 1 volt is available at the cathode and 30 volts at the plate. Output taken from the plate circuit must be fed into a high impedance load which will not upset the electrical constants of the circuit thus causing frequency variation and instability.

The RC oscillator is extremely stable, since the frequency is determined by the RC network. Variable condensers have a very slight capacity change due to temperature variations, which in most applications can be disregarded. Carbon resistors are perfectly satisfactory for normal temperature changes but cause a frequency variation of approximately 10% when the temperature is varied from +70 to -55 degrees Centigrade. Metalized resistors are readily available and vary approximately 2% over the temperature cycle mentioned above. The use of metalized resistors is desirable. The variation of the other resistor values due to temperature causes little or no effect with the exception of  $R_2$ .

### Construction Considerations

Fig. 2 is a circuit diagram of an RC oscillator with isolation stages and a built-in vacuum tube voltmeter. This unit is quite similar to an RC oscillator now manufactured commercially. Before constructing an RC oscillator, the use of the oscillator should be considered. If the oscillator application only requires fixed frequency

operation, the addition of the two isolation stages may not be required.

Building in a vacuum tube voltmeter may be of no particular advantage. In that case the oscillator would only require three tubes, one being the rectifier. Such units can be constructed in an extremely short length of time with a minimum of parts and expense. Many such oscillators were constructed and used twenty-four hours a day in production. Such oscillators have been known to operate at 400 cycles for weeks with a frequency variation of only a few cycles. If the oscillator is to be used as a general purpose piece of equipment, it becomes desirable to add the isolation stages. The addition of a built-in vacuum tube voltmeter is desirable when the equipment is used for making fidelity measurements. The vacuum tube voltmeter circuit in Fig. 2 is extremely simple, consisting of few parts, and will alleviate the necessity of borrowing a voltmeter from some other test position each time a fidelity run is made.

To help the reader determine how much of the equipment he needs to build to meet his particular requirements, an outline is given of the equipment necessary to make certain tests.

1. *Frequency Measurements*—An oscillator with an accurate calibration and an oscilloscope or headphones. If extremely accurate measurements are required, the oscillator should be checked against a secondary standard



### CRYSTALS MTD "AT" CUT NEW GTD 85c; 4 for \$3

6250 to 6750 (6mtr)  
6757 to 6863 (11mtr)  
7000 to 7425 (40, 20, 10mtr)  
8335 to 9000 (6mtr)

**ACTIVE OSC'S GTD**  
**DC-9 STD 100KC**  
± 10cy ..... \$5.95  
**DC-15A STD 200KC**  
± 10 cy ..... 5.95  
**100 KC STD** ..... 7.20

Condsr kit qty silver micas. 50 for..... \$ 2.00  
Resistor kit 100BT $\frac{1}{2}$  & 1W. 50 to 2 megohms... 2.50  
Control kit AB4. 50 to 2meg, 10 for..... 2.50  
Kurrman 1000KC hummer op 6.3V (\$9)..... .97  
Cased Hmically sealed Transformer Pri 50/  
800cy 105-125x80V; Sec 100VCT & 300/  
110ma. 6.3V/5A, 5V/3A, 6.3V/65A, 6.3V/  
.65A, 6.3V/1.25A & Two cased H sealed  
10H/110ma chokes & Two Condsrs 3mf/  
330VAC 1000 WVDC Pyranol & RX60 &  
socket ..... 9.00  
Raytheon cased 840VCT/110ma, 530VCT/  
21ma, 5V/3A, 5V/3A, 6.3V/1A, 6.3V/6A,  
115V/60 Pri & Two 10H/110ma H sealed  
chokes & oil Condsrs 2/2.5mf & 5mf/600-  
WVDC/oil ..... 5.95  
Thermador Cased SC Rated Cont 3800VCT/  
6KW/2.7 Amps, Primary 200, 210, 220, 230,  
240, 440; 50/60cys (\$365) "TAB" SPECIAL 45.00  
Collins cased 6H/1.2Amp/12500VW ..... 16.00  
Amphenol octal sockets mica B S83N, 25 for. 1.50  
Cinch Loctal sockets with saddle, 21 for..... 1.50  
Amphenol Marginal sockets 48S11L ..... .39  
Condsr GE Pyranol 15mf/330VAC/1000-  
WVDC ..... 2.75  
Condsr GE Pyranol 30mf/660VAC (3 units). 8.10  
Condsr Westchse 2mf/12500WVDC (\$210) ..... 25.00  
Condsr Westchse 1mf/25000WVDC (\$395) ..... 75.00



**NEW NAVY DY-NAMOTORS EICOR DC GTD** overseas packed, AN insp Hi-eff. CONT. duty, input 12V/4A or 24V/2A, output 500V/50ma; In-put 12V/8A or 24V/4A output 275V 110 ma & 12V/3A. Either UNIT \$1.95 or both units (2) & filter \$3.49. Wgt. 9 lbs., 7 $\frac{3}{4}$ " L x 2 $\frac{7}{8}$ " H x 4 $\frac{1}{4}$ " W. Adaptable to 6V operation. Alnico field.

## "TAB"

### That's A Buy

Cathode Ray Transf Pri 115V/60cy; Sec 1000VCT .055ma & 795/360V/.08ma. 5V/3A, 5V/3A, 6.3V/1A, 6.3V/0.3A & 3BP1 tube & socket..... \$7.50  
Littlefuse 250ma/3AG (LP .25), 48 for..... 1.00



### WESTON MODEL 796

Portable insulation tester and megger NEW NAVY termination. Tests insulation and resistance up to 200 megohms, test potential 350 to 500 vdc. Resistance 0.20-200 megohms .5 and 5 megohms center scale. 4" sq. 50 micro-amp mtr. less batteries, test leads and carrying case (LP \$100) ..... \$16.95  
With carrying case \$24.75; Parts for 500V-AC supply \$9.

**IF YOU DON'T SEE IT—WRITE FOR IT**  
Crystals IN21 22, 23, 25 GTD, 4 for..... \$1.50  
Condsr oil 20mf/600WVDC (1-2-4-5-5mf) ..... 1.50  
LS-3 Perm Mag V hvy duty Spks (LN). 4.95

\$2 Min. order FOB N.Y.C. Add Postage all orders and 25% deposit. Whitehall 3-3557. Send for catalog 99 Specialists in International Export, School, College & Industrial trade. Moneyback "TAB" Guarantee.

RCA 808 JAN-CRC New Gtd Fil 7.5V/4amp Plate 1500V/200 Watts, Rated 140 watts output each "UHF" (list \$7.75) "TAB" \$2.75 ea. 2 for \$5.00  
GE&WST 807 \$1.35 ea. 2 for. 2.50  
920B/3E29 & socket..... 1.25  
GE&RAY 955 65c ea. 2 for..... 1.25  
RCA 956 & Socket..... 1.25  
957 or 958A & Socket..... 1.25  
805/905 & Socket \$6. 2 for. 11.00  
GE446A/2C40 Lighthouse (\$11) 6.95  
GE845 & Sockets \$7.50, 2 for. 14.00  
NU 2V3G/16500V Rect (\$3.90) .75  
RCA 6AC7, Boxed, new, 4 for. 3.00  
2C6B UHF (LP\$5) ..... 1.95  
6AK5 boxed \$1.25 ea. 2 for. 2.00  
6AG5 boxed \$1.50 ea. 2 for. 1.30  
3A4 new (LP\$2.50) ..... 1.65  
9006 (LP\$1.60) 70c ea. 2 for. 1.25



872A New & socket, 2 for..... \$5.75  
YR150 New (LP\$3.20) 85c ea. 2 for. 1.50  
5BP1 or 5HP4 New & socket..... 9.95  
5CP1 & socket \$7.50; 3BP1 & socket..... 3.95  
6SN7 new (LP\$1.80) 80c ea. 2 for..... 1.45  
6J5 new (LP\$1.35) 65c ea. 2 for..... 1.20  
6V6 new (LP\$1.50) 83c ea. 2 for..... 1.60  
6CS new (LP\$1.80) 75c ea. 2 for..... 1.40  
2X2 new (LP\$3.20) \$1 ea. 2 for..... 1.80  
1D21/631-P1 STROBOTRON (LP\$6) 4.50  
WE703A tube UHF/1000mc (LP\$40) 5.95  
WE307A RF Pentode (LP\$13) 5.95  
WE309A RF Pentode (LP\$24) 6.95  
WE174 Door Knob tube new (\$7.50) 1.95  
1225 New beam (S807) 70c ea. 2 for. 1.50  
RCA-3 (LP\$1.35) 85c ea. 2 for. 1.10  
RCA-1E7G (LP\$3.20) \$1.50 ea. 2 for. 2.50  
RCA-614 UHF (\$9.50) ..... 2.49  
6G5/6U5 RAY eye tubes (LP\$1.80), 2 for. 1.00  
9002 New boxed ICA (LP\$2.50), 2 for. 1.10  
GE 1641/RK60 new FW 11V Rect (\$2.75) 1.95  
RX215 Raytheon new FW 500V/15Amp (LP-\$24) 7.95  
GE Vacuum Condsr 50mmfd/16000V..... 3.95  
New TBY Vibrator pack & S' Battery, Manual 9.95

Raytheon 866A filament transformer 115V 60c pri. 2.5Vet 11A Sec and Two new RCA 866A tubes ..... \$5.90  
With Miller caps and sockets ..... \$7.00  
Raytheon Transformer only ..... \$3.25



872A's combination Rectifiers, Transformer Kenyon & sockets, NEW GTD \$12.

**"TAB" • Dept. RNI, Six Church Street, New York 6, N. Y., U.S.A. • "TAB"**



# MINERVA

*Makes Radio History...*

with **NEW TABLE MODELS!**



**Model 702H**

6 tube AC-DC superheterodyne—loop antenna—RF stage—illuminated slide rule dial—beam power output—Alnico V dynamic speaker—flawless plastic cabinet—walnut or mahogany.



**Model 117-3**

8 tube—2 band AC-DC superheterodyne—Push-pull beam power output—Tone control—6" Alnico V dynamic speaker. Illuminated dial. Exquisite cabinet of selected mahogonies.



**Model 702B**

6 tube AC-DC superheterodyne—built-in loop antenna—RF stage—Alnico V dynamic speaker—Full vision inclined slide rule dial—Plastic cabinet—walnut or mahogany—with woven duotone metal grille.



**Model W-728**

5 tube AC-DC superheterodyne—Self contained loop antenna—Powerful Alnico V dynamic speaker—Beam power output—Edge lighted slide rule dial—Streamlined hardwood cabinet maple or walnut finish.



**Model W-713**

6 tube radio phonograph with automatic record changer—AC only—removable radio unit slips into cabinet for full range phonograph reproduction or supplies excellent broadcast reception by itself. Unit operates with closed lid. Leatherette covered. Easy portability.

**IMMEDIATE DELIVERY  
ORDER NOW!**



*Since 1919 The Aristocrat of Home Radios*

A few territories now open for live-wire distributors. Write today for details.

**MINERVA CORPORATION OF AMERICA**  
238 William Street • New York 7, New York

DOMESTIC SALES: Minerva National Sales Corporation, 78 Reade Street, New York 13, New York • EXPORT SALES: 238 William Street, New York 7, New York



# MASTER-PRO

Meets All NAB Standards

## The QUALITY Transcription and Recording Equipment

ALL NEW POST-WAR MODELS

### MODEL "V"

Recording Turntable Illustrated

### MODEL "M-5"

Recording Mechanism Illustrated Mounted



## "MASTER-PRO" M-5 RECORDING MECHANISM WITH CUTTER

**RUGGEDNESS:** Fifteen pounds of steel and bronze, chrome plated, assures long wear and the ability to stand up against rough treatment.

**QUALITY:** The "Master-Pro" M-5 is machined to tolerances unheard of in pre-war production.

The "Master-Pro" M-5 is a universal machine that can be readily attached not only to the Master-Pro V Recording turntable, but to any other make of turntable that has the standard center pin.

Standard screw cuts 120 line per inch outside-in. Feed screws for 105 or 120 line outside-in or inside-out, substituted at purchaser's request.

### "MASTER-PRO" MODEL-V 16" RECORDING TURNTABLE

A precision-constructed instrument, unsurpassed in quality and performance... operating in many of the leading broadcasting stations and educational institutions.

#### SPECIFICATIONS:

14-lb. L-ribbed cast iron chassis. Lathe turned aluminum cast turntable. New specially constructed smooth powerful constant speed motor. Neoprene idlers.

### "MASTER-PRO" VM-2 RECORDING LEVEL METER



Mounted in an unbreakable, cast aluminum case, the VM-2 Recording Level Meter takes recording out of the hands of the expert. It enables the artist to watch the volume of his recording while performing and is readable up to 25 feet. The possibility of overcutting is reduced to a minimum. Wired to operate from the output of an 8, 15, 200 or a 500 Ohm amplifier.

Telephone: **TRF** Longacre 3-1800

# HARVEY

RADIO COMPANY INC.

103 West 43rd St., New York 18, N. Y.

to correct any errors that might exist. By feeding the unknown frequency into the vertical plates of the scope and the audio oscillator into the horizontal plates, it is possible to use a circle pattern to indicate exact resonance. This gives a much higher degree of accuracy than headphones in that the frequency response of headphones is extremely poor for very low frequencies. If the oscillator is to be used primarily for this type of measurement, the addition of the isolation stages and vacuum tube voltmeter would be just so much excess equipment.

**2. Fixed Frequency Voltage Generators**—In many applications for test equipment, such as a production line, it becomes desirable to have a fixed frequency source of voltage that has a stable and constant output. Such voltages are fed through transmission lines throughout the production area and become available at convenient terminal boxes. The construction of the oscillator for this particular type of application can simply consist of a small power supply and a 2 tube RC oscillator without the variable condenser, making a very compact unit. Selection of the RC network values will produce the frequency desired, and the equipment will require little or no attention. Where several frequencies are required simultaneously, separate oscillators can be constructed. If several fixed frequencies are required, but operation of only one frequency at a time, the addition of a switch and various combinations of RC network will produce the desired results.

**3. Fidelity Measurements**—Equipment necessary consists of a variable frequency oscillator, level indicator and standard output meter. For this particular application it becomes desirable to build a piece of equipment such as Fig. 2 in its entirety.

**4. Distortion Measurements**—This type of measurement requires an audio oscillator free from distortion (less than 1%), a standard output load or meter and a wave analyzer or distortion meter. For this application the vacuum tube voltmeter built into the equipment is not necessary, but the use of the isolation stages is desirable, since it may be necessary to feed an input circuit of a low or high impedance. The isolation stage alleviates the possibility of some reflection back into the oscillator which might cause an error in measurement.

#### Construction

The layout for this piece of equipment is quite conventional, with the power supply to the rear and side, variable condenser in the center and the oscillator, isolation tubes and vacuum tube voltmeter tube on the other side. The location of all parts above the chassis should be at least 1" clear of the variable condenser. The variable condenser must be shielded, and this 1" of space allows the shield to be sufficiently large so that capacity be-

## MORE SMASH BUYS at National Radio Distributors

NOW! IMMEDIATE DELIVERY!  
THE NEW & IMPROVED NATIONAL RADIO KITS  
The Original and still the Finest



All parts brand new. No War Weary Surplus. All parts perfectly matched and mounted on chassis for easy wiring. Powerful Alnico P.M. speaker and beautiful Plastic Cabinet with Dust-Proof back furnished with all Kits. Built-In loop antenna, and Illuminated Airplane dial. Full instructions.

**MODEL N.R. 7-5 TUBE** 105-125 V. A.C./D.C. SUPERHETERODYNE. Uses 12SA7, 12SK7, 12SQ7, 50L6 & 35Z5 Tubes. \$11.95  
Kit of 5 Matched Tubes. 4.95  
**MODEL N.R. 5-5 TUBE** TWO BAND A.C./D.C. SUPERHETERODYNE, as above. Freq. Range 550-1600 K.C. & 5.5-18 Megacycles. \$13.95  
Kit of 5 Matched Tubes. 4.95  
**MODEL N.R. 6-6 TUBE** A.C./D.C. SUPERHETERODYNE. Uses 12SK7, 12SA7, 12SK7, 12SQ7, 35L6 & 35Z5 Tubes. \$13.75  
**MODEL N.R. 1-1 TUBE** A.C./D.C. T.R.F. Uses 12SK7, 12SQ7, 50L6 & 35Z5 Tubes. Highly recommended for Students, Schools, Hospitals & Institutions. \$10.95  
Kit of 4 Matched Tubes. 3.95

### MODEL P.R. 7- PORTABLE RADIO-PHONOGRAPH COMBINATION KIT



- Powerful 5 Tube Superheterodyne Radio, with Self-Contained Loop antenna and Alnico speaker.
- Self-Starting Phono-Motor, and Feather-weight Crystal Pick-up arm. 9" Turntable.
- Numerous Leatherette covered carrying case. \$27.50

Kit of 5 Matched Tubes 4.95  
Manufacturers, Jobbers, Exporters! Write for quantity prices.  
White Plastic Cabinets available for Radio Kits. \$1.00 additional.

Terms: At least 25% with order. We will ship balance C.O.D.

Write for our Complete Catalog. It's Free.

## National Radio Distributors

899 a Southern Blvd., New York 59, N. Y.

## R-L SPECIALS for IMMEDIATE delivery

### Wireless Phonograph with Automatic Record Changer



No wires to connect. Just Plug in and play through radio. 45 minutes of uninterrupted plays of 10 or 12 inch records without reloading. For 110V. 60 cycle operation. Complete with open type walnut veneer cabinet. Shipping weight 14 1/2 lbs.  
B6200—Net. each. \$27<sup>06</sup>

### Hand Wound Portable Phonograph

Battery operated amplifier, hand wind motor. No electric current necessary. Excellent for use at beach, picnic, porch, or wherever electric current is not available. Attractive two-tone leatherette covered case. Size: 14 1/2" x 15 1/2" x 8". Uses Burgess battery pack #6TA60. \$28.44  
B6202—Net. \$3.60  
#6TA60—Battery Pack \$3.60



Write for FREE Parts Catalog

# R-L Electronic Corp.

731 West Washington Boulevard  
Dept. N CHICAGO 6, ILLINOIS



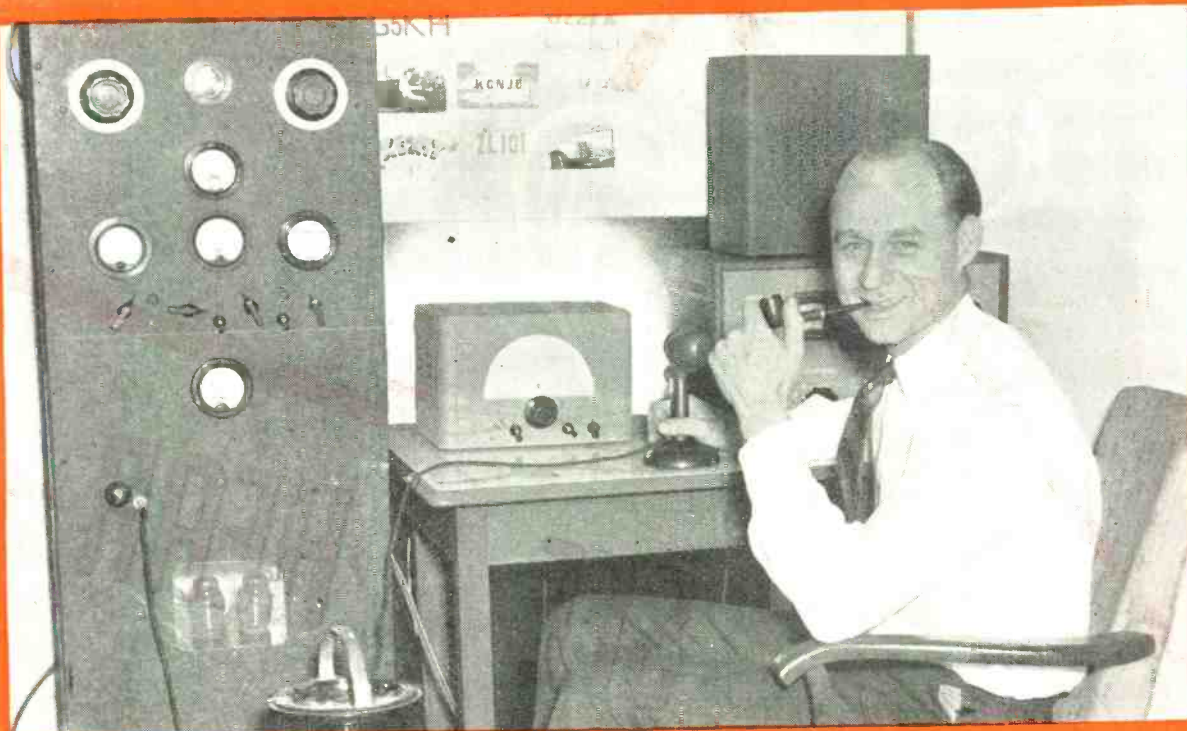

## The Collins 70E-8 wins an Enthusiastic Booster!

Frank W. Oberlander, W9YPS

When W9YPS got his 70E-8 PTO (permeability tuned oscillator), we asked him to give it a workout and send us his comments. He did, and we'd like to quote him:

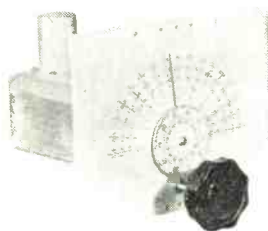

Frank's exciter line-up, following the 70E-8, consists of a 6AK6 isolator (untuned), 6AG7 buffer-doubler, 7C5 buffer-doubler. Here are some of the reasons why he's happy with his PTO:

1. The 70E-8 is accurate to within  $\frac{1}{2}$  kc on 80 meters.
2. It's calibrated directly in frequency.
3. The frequency range of 1600-2000 kc is covered in sixteen turns of the vernier dial.
4. The stability is within 1 dial division.
5. The dial covers the 80, 40, 20, 15, 11, and 10 meter bands.

Write for an illustrated bulletin with full details.

Collins Radio Co.  
Cedar Rapids, Ia.

Gentlemen:

I wish to express my appreciation of the new 70E-8 PTO. I have used this unit since the latter part of July on 75 meter phone, 80 meter cw, 20 meter phone and cw and 10 meter phone and cw. I cannot fully describe the feeling of assurance that this unit affords in the matter of stability and ease of frequency spotting. I am sure it has enabled me to make many contacts that otherwise I would not have made. All reports are very favorable as to stability and freedom from chirps. All contacts on cw were greeted with T9X reports.

It certainly is one of the finest pieces of equipment that I possess and I would truly feel lost if I had to be without one.

Yours very truly,

Frank W. Oberlander (W9YPS)  
457 Fifer Street  
Galesburg, Illinois

Galesburg, Illinois  
October 1, 1946

FOR RESULTS IN AMATEUR RADIO, IT'S . . .

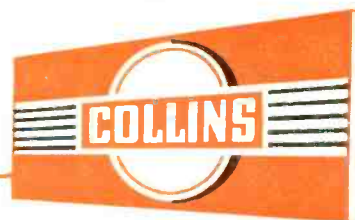

**COLLINS RADIO COMPANY, Cedar Rapids, Iowa**

11 West 42nd Street, New York 18, N. Y.

458 South Spring Street, Los Angeles 13, California





Now you can **SEE** and **HEAR** the



SIGNAL TRACER  
MODEL CA-12  
SUPERIOR INSTRUMENTS CO.  
NEW YORK, U.S.A.

The Model CA-12 comes complete with Detector Probe, test leads, self-contained batteries and instructions. Comes housed in heavy gauge crystalline cabinet with beautiful two tone etched front panel. NET PRICE

\$34<sup>85</sup>



signal with the new **CA-12**

# SIGNAL TRACER

The latest of a long line of Signal Tracers designed by *SUPERIOR*. The new Model CA-12 permits you to SEE and HEAR the signal reducing the time required to locate the source of trouble in radio receivers to a new minimum. Quantitative and Qualitative analysis of the signal is made amazingly easy with the aid of this new versatile tool. As the detector probe is moved to follow the signal from antenna to speaker, the *SIGNAL INTENSITY* can be read directly on the meter. Then a flip of the switch permits you to hear the *QUALITY* of the signal in the Alnico V Speaker. Since the introduction of signal tracing in 1939 we have worked continuously developing and improving this simplified "short cut" method of radio servicing. This new model provides all the services of previous models plus many additional advantages, yet operating time has been reduced to an absolute minimum. Always ready for instant use it takes less than five seconds to begin using this versatile unit. No maze of special cables—the Model CA-12 uses only one connecting cable. No line cord the CA-12 operates on self-contained batteries and no tuning controls of any kind are used in the model. To operate it is necessary only to throw the switch and immediately use the Detector Probe to follow the signal from antenna to speaker, with relative signal intensity readings available on the scale of the meter. The meter is calibrated to permit constant comparison of signal intensity as the probe is moved to follow the signal through the various stages.

*Manufactured by* **SUPERIOR INSTRUMENTS COMPANY**

227 FULTON STREET \* NEW YORK 7, N. Y.

## FEATURES :

- ★ COMPARATIVE *INTENSITY* OF THE SIGNAL IS READ DIRECTLY ON THE METER — *QUALITY* OF THE SIGNAL IS HEARD IN THE SPEAKER.
- ★ SIMPLE TO OPERATE—ONLY ONE CONNECTING CABLE—NO TUNING CONTROLS.
- ★ HIGHLY SENSITIVE—USES AN IMPROVED VACUUM-TUBE VOLTMETER CIRCUIT.
- ★ TUBE AND RESISTOR CAPACITY NETWORK ARE BUILT INTO THE DETECTOR PROBE.
- ★ BUILT-IN HIGH GAIN AMPLIFIER—ALNICO V SPEAKER.
- ★ COMPLETELY PORTABLE—WEIGHS 8 POUNDS—MEASURES 5½" x 6½" x 9".



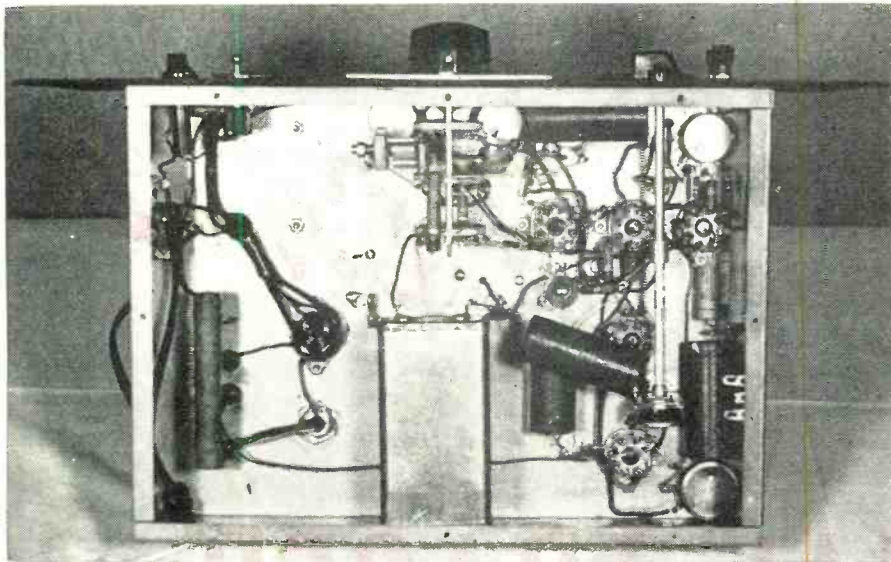

Under chassis view of Wien Bridge audio oscillator.

tween the shield and the variable is kept at a minimum.

Capacity caused by the shield will reduce the high frequency range of the oscillator. Three variable resistors are located in the immediate vicinity of the range switch and are in series with the RC network resistors. The network resistors were checked on an ohmmeter, and due to production tolerances, the lowest value of resistance was placed in series with the variable

resistor to ground. This made it possible to match both resistor networks. These resistors also give a small amount of frequency variation which allows the operator to make corrections in the calibration so that one calibration will hold for all three ranges.

The coupling condenser between the 6SJ7 and the 6G6 was mounted above the chassis to reduce capacity of the condenser to ground. The gain con-

trol was located at a point where lead length could be kept at a minimum. Locating the gain control on the panel would have eliminated the use of an extension shaft but would have, in turn, required the use of shielded leads to and from the control.

Shielded leads will cause a high frequency attenuation which results in reduced output at high frequencies. Note the addition of a 50  $\mu$ fd. variable condenser shunted across the top section of the variable condenser. This capacitor is adjusted to compensate for the capacity of the frame of the variable to ground.

The operation of the isolation stages is as follows: The first 6J5 operates as a cathode follower. The coupling to the second 6J5 is accomplished by the common cathode resistor of the two 6J5s. The plate circuit of the second 6J5 is conventional. This type of amplifier lends itself admirably to this particular application in that it is practically distortionless up to 15 volts output, and at 25 volts the distortion is less than 2%. Since distortion measurements normally require low level, the amplifier proves quite adequate. The construction of distortionless amplifiers of conventional type requires considerably more parts, adding expense to the unit. The vacuum tube voltmeter consists of one-half of a 6SL7 being used as a diode and the other half as a vacuum tube voltmeter. The power supply is quite conventional. The use of a metal plate

## 1907-1947

We honor you, Dr. Lee de Forest on the occasion of the 40th anniversary of your vacuum tube, the historic audion.

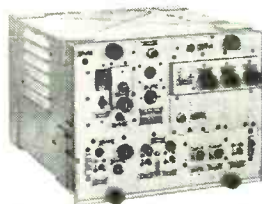

Transmitter and receiver have been widely used on the 144MC band. Just released from the Government as surplus. Shipping weight 100 lbs. Your priceless tubes and power transformer. **\$14.95**

Thordarson Swing Choke 2-7 HY, 55-550 MA. In original box. **\$7.95**  
Meters 0-1 MA. Westinghouse 2" round case **2.95**  
Meters 0-1 amp. R.F. Westinghouse 2" round case **2.95**  
Thordarson 8HY, 175M choke. In original box **1.49**

### TUBES

955-9004 **.65**  
Sockets for Acron tubes **.19**  
VR 150 voltage regulators **.49**



Condenser oil filled, hermetically sealed, 8.5-8.5 M.F.D., 1000 V.D.C., convertible to 4.25 M.F.D., 2000 V.D.C., 5 1/4" long, 2" wide, 5" high. **\$3.95**  
A wonderful coil which can be used on high frequency aluminum can. 30MC, I.F. transformer. Silver slug tuned. **.29**  
Mica capacitor .002 M.F.D., 3000 V.D.C. **.89**

## 1912-1947

We have been honored by having had the privilege of serving the radio electronic field for 35 years.

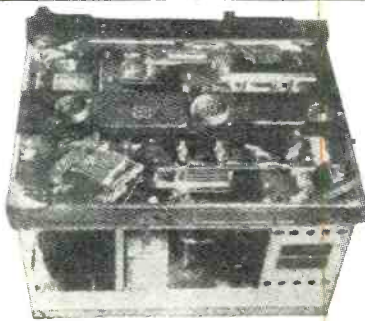

SCR-522100-156 MC. receiver and transmitter. Transmitter output 3-9 watts, voice amplitude modulated on any one of our crystal controlled frequencies. Receiver is readily switched to either one of the 4 present crystal-control channels.

### SELSYN MOTORS

The ideal way of indicating the position of rotary beams, wind indicator, etc. **2 for \$3.95**  
V.A.C. operation furnished. **for \$3.95**

Tubes used: 2-832; 3-12A6; 1-6G6; 2-6SN7; 1-12J5GT; 1-12C8; 1-9002; 3-9003; 1-12AH7GT; 3-12SG7. Price new—complete as shown **\$59.95**. Price used—complete as shown **\$39.95**.

### BLEEDERS

75M. OHM—200 watt. **\$0.49**  
2500 OHM—100 watt adj. **.49**  
20% deposit on all C.O.D. orders.

**HERSHEL RADIO COMPANY**  
5249 GRAND RIVER  
DETROIT 8, MICH.



Dynamotor Power Supply—inputs 6 or 12 V. output 500 VDC at 160 MA mounted on box with circuit breakers, relays, interference filter and two 10 foot cables. Army surplus. Shipping weight 84 lbs. **\$9.95**

### TRANSFORMERS

6.3V—6 amps. 110 V.A.C.—60 cycle. **\$1.49**  
Coaxial cable—RG. 54 A/U-58 OHM per ft. **.06**  
Amphenol coax fittings—male **.35**—female **.25**

### CONDENSERS

100 M.M.F.D. variable A.P.C. type silver plated. **.59**  
30 M.M.F.D. variable A.P.C. type silver plated. **.25**  
12 M.M.F.D. variable 3/4" shaft. **.30**  
Johnson neutralizing condenser for 250 T.H. **.95**  
12 M.M.F.D. vacuum condenser—20,000 VDC. **3.95**  
5/8" and 3/4" powered-iron slugs—6-32 screw shaft **.10**  
Hallcraft tuning knobs SX28. **.29**

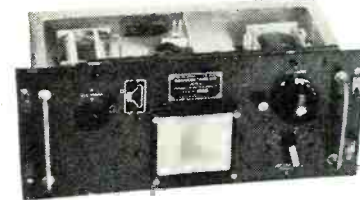

Tuning unit V.C. 375. Each unit has 3 double spaced unit cond. approximately 65 M.M.F.D. coils, SW chokes, national velvet dials and assorted mica condenser 2500 WVDC; over \$50.00 in parts. **\$3.75**



# Metropolitan

fills Mail Orders **Same day received!**

## The New Model CA-12

# SIGNAL TRACER

Manufactured by Superior Instruments Co.

Completely Portable with Batteries, Probe and Instructions.



### \* FEATURING \*

Comparative Intensity of the signal read **DIRECTLY** on the meter.

Quality of the signal is heard **DIRECTLY** on the speaker.

Simple to operate ... only one connecting cable ... **NO TUNING CONTROLS**

The Model CA-12 comes complete with Detector Probe, test leads, self-contained batteries and instructions. Comes housed in heavy gauge crystalline cabinet with beautiful two-tone etched front panel.

# \$ 34<sup>85</sup>

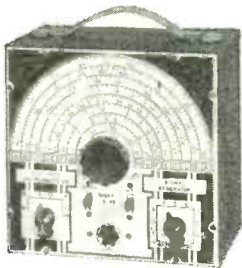

### The New Model B-45 BATTERY OPERATED SIGNAL GENERATOR

R.F. frequencies from 150 Kc to 12.5 Mc on Fundamentals and 11 Mc to 50 Mc on Harmonics

**\$27.75**



### The New Model 670 SUPERIOR SUPER METER

Combination volt-ohm milliammeter plus capacity reactance inductance and decibel measurements

**\$28.40**



### The New Model 450 SUPERIOR TUBE TESTER

"Speedy Operation" assured by newly designed rotary selector switch which replaces the usual snap toggle or lever action switches.

**\$39.50**

NET



### The New RCP Model 802N COMBINATION TUBE & SET TESTER

DC Voltmeter 0 to 1000 at 1000 ohms per volt. AC Voltmeter 0 to 1000 DC Milliammeter 0 to 1000. Ammeter 0 to 10. D.B. Meter—8/15/15 to 29/29 to 49/32 to 55 decibels.

**NET \$59.50**



### The New McMurdo Silver Model 905 "SPARX" DYNAMIC SIGNAL TRACER

Frequency range from 20 cycles to over 200 megacycles.

**NET \$39.90**



### The New McMurdo Silver Model 904 CAPACITANCE RESISTANCE BRIDGE

1/4 mmfd/ohm through 1,000 mfd/megohms 0-50% power factor

**NET \$49.90**

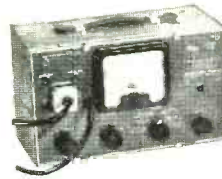

### The New McMurdo Silver Model "Vomax" VACUUM TUBE VOLTMETER

One of the finest test instruments of its type.

**NET \$59.85**

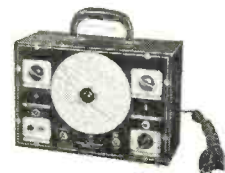

### The New RCP Model 705 SIGNAL GENERATOR

From 95 Kc to 100 Mc, continuously variable. Planetary drive condenser. Self-contained electronic modulation 400c sine wave for external use

**NET \$49.50**

SUPREME 543 Multi-Tester... \$ 18.95  
 SUPREME 589 Tube & Battery Tester... \$ 48.95  
 SUPREME 599 Tube & Set Tester... \$ 62.50  
 SUPREME 565 Vacuum-Tube Voltmeter... \$ 63.50

SUPREME 576 Signal Generator... \$ 68.95  
 WESTON 689-1F Ohmmeter (list \$25.50)... \$ 14.85  
 RCP 322 Dynoptinum Tube Tester... \$ 41.50  
 WATERMAN Pocket Oscilloscope... \$ 55.00

RCP 664 Electronic Multimeter... \$ 45.00  
 RCP 668 Vacuum Tube Volt-Ohm Capacity Meter... \$ 74.50  
 RCP 665 A.V.T. Volt Ohmmeter Insulation Tester... \$ 94.50  
 DUMONT 5" Oscilloscope... \$ 99.50

MONITOR Crystalline Signal Generator... \$ 57.50  
 SHALLCROSS 630 Wheatstone Bridge... \$ 75.00  
 SHALLCROSS 637 Kelvin Wheatstone Bridge... \$100.00  
 SHALLCROSS 638 Kelvin Wheatstone Bridge... \$150.00

TERMS: 25% deposit, balance C.O.D. or Full Payment with order

**SEND FOR FREE CATALOG!**

# Metropolitan

**ELECTRONIC & INSTRUMENT CO.**

Dept. R, 6 MURRAY STREET  
 NEW YORK 7, N. Y., U. S. A.

Cable Address: METRONICS

Phone: BArlay 7-5556



# The JOHNSON "Q"

CONDENSERS  
INDUCTORS  
TUBE  
SOCKETS  
INSULATORS  
PLUGS  
AND  
JACKS

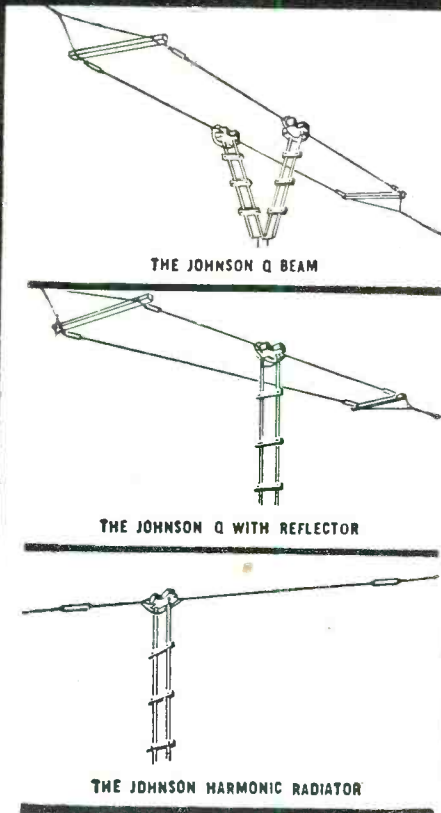

This highly efficient system is applicable to a wide variety of antennas, including the sensational "Q" Beam, Radiator-Reflector and Radiator-Director Beams, Harmonic Radiators, "V" Beams and many others. With all these the following advantages are realized:

- Matched impedances throughout with greater radiation from the same transmitting power than may be obtained with ordinary non-matched antenna feeder systems.
- Permits use of open wire line resulting in exceptionally low transmission line loss — about 1/10 that of "twisted pair" lines.
- No exact or critical overall line lengths. Line may be several hundred feet long if desired.
- Easily installed and adjusted — complete data supplied.
- Available for all the radio amateur bands from 80 to 1 1/4 meters.

Dept. Z

**JOHNSON**  
a famous name in Radio

E. F. Johnson Co. Waseca, Minn.

over the bottom of the chassis is desirable but not absolutely necessary. Stray fields entering the bottom of the chassis will give an indication of distortion in excess of 1%. All parts values can be of 10% tolerance other than the RC network and the negative feedback resistor.

The selection of parts and tube types was dictated by the availability of such material at the time. This accounts for the unusual tube type selection. It is recommended that the 6SJ7 and the 6G6 be used in the oscillator, but the two 6J5s may be replaced by one 6SN7. The 6SL7 can be replaced by a 6H6 and a 6SQ7. The 80 type rectifier tube can be replaced by a 5Y3 or equivalent. The choice of power transformer was dictated by procurement rather than by design. Since the power supply voltage was too high, it became necessary to add a voltage divider. The current drain of the equipment is approximately 30 mls, so a low voltage transformer can be used by simply adjusting the output voltage between 180 and 200 volts.

### Tuning Procedure

Adjust the correcting resistors in the RC network so the range switch decades. With the range switch in No. 1 position and the variable condenser closed, the frequency should be 15 cycles. Rotate the range switch to No. 2 position. Adjust for 150 cycles. With the range switch in No. 3 position, adjust for 1500 cycles. Of course, such adjustment will not be possible if the RC network resistors do not increase in steps of 10.

In this case it becomes necessary to calibrate the dial for all three ranges, or add or subtract resistance values until the calibration does decade. The negative feedback resistor may require adjustment. This adjustment is made by substituting a 10,000 ohm potentiometer and finding the correct value as outlined. Connect an a.c. vacuum tube voltmeter to the output jacks and adjust output for approximately 5 volts. Now rotate variable condenser from minimum to maximum capacity. If the output varies over 5%, adjust the 50  $\mu$ fd. condenser across the top section of the variable to correct this deviation. The adjustment of this condenser will affect the calibration slightly and may necessitate re-calibration.

### Vacuum Tube Voltmeter Adjustments

Reduce the audio output of the oscillator to minimum. Adjust the 10,000 ohm variable resistor in the cathode of the 6SL7 for full scale deflection. Adjust the oscillator gain control for 5 volts output. Next, adjust the one megohm potentiometer in the diode circuit so the meter reads half-scale. With these adjustments the oscillator is ready for use and should have a distortion content of less than 1%. The use of a wave analyzer or distortion meter will allow more precise adjust-

## FACTORY CLEARANCE SALE

CAPACITORS: Oil-filled, C-D & Aerovox. Removed from equipment which was never used.	
Bath-tub Type—600 volt dew.	
0.05 mfd.	\$ 0.19
0.50 mfd.	.33
0.25-0.25 mfd. dual	.49
1.0 mfd.	.39
2.0 mfd.	.49
Universal mounting, C-D Type TTH & Aerovox Type X 10.0 mfd.—600 volt dew.	.98
10.0 mfd.—1,000 volt dew.	1.50
CAPACITORS: Electrolytic, New, Upright can.	
20 mfd./150 volt dew—1,000 mfd./5 volt dew. dual	.49
20-60 mfd., 400 volt dew, dual	.59
OSCILLOSCOPE: BC-412, brand new with tubes	
	48.28
SELSYNS: 115 volt, 60 cycles, Bendix Type 1-1. Per pair	
	7.50
CIRCUIT BREAKERS: Heinemann, 15 Amp. & 5 Amp., 115 volt, ac.	
	.98
TRANSFORMERS: Impregnated & sealed in steel cases. Thordarson, UTC, Stancor, etc.	
115 volt, 60 cycle primaries	
Filament: Sec. 1, 2.6 v. @ 10.0 Amps.; Sec. 2, 6.4 v. @ 5.5 Amps. CT; Sec. 3, 6.4 v. @ 1.0 Amp. CT	1.89
Plate: Sec. 1, 1230 v. @ 262 ma. CT; Sec. 2, 18 v. @ 1.0 Amp.	3.49
	6.95
RHEOSTAT: 3,000 ohms, 5%, 25 watts.	
	1.59
POTENTIOMETER: 5,000 ohms wire-wound	
5%	.29
100,000 ohms, 10%, Taper "A"	.29
TUBES: New, not in cartons. RCA, Sylvania, Ken. Rad., WE	
6AC7/1852	.99
6SJ7	.49
6SL7	.69
6SN7 VR-105/30, VR-150/30	.59
6L6, 6L6G	.84
6AK5	1.79
6X5GT/G	.75
2AP1, 2" CRT	3.95
5HP4, 5" CRT	6.95
RELAY: Struthers-Dunn, SPDT, 18 vac. coil; 115 vac. 8 Amp. contacts.	
	2.00

All prices are Net, FOB factory. Deposit Must Accompany All C.O.D. Orders.

**CAMBRIDGE ELECTRONICS CORPORATION**  
Manufacturers of Electronic Control Equipment  
208 S. Pulaski Street  
Baltimore 23, Maryland

## Inside Facts About ROUWE No. 7 PERMANENT MAGNET

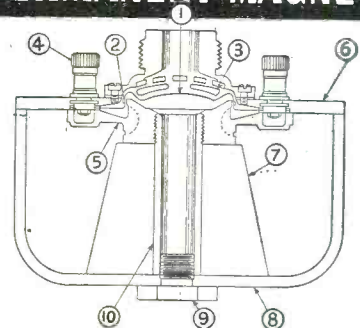

- 1—One-piece metal diaphragm. Voice coil wound on diaphragm.
- 2—Horn mounting accurately centered.
- 3—Perforated die-cast palate.
- 4—Cadmium plated heavy-duty binding posts.
- 5—Flange molded to inner pole piece.
- 6—Outer pole piece of special alloy.
- 7—Heavy ALNICO permanent magnet.
- 8—Bowl of heavy gauge steel.
- 9—Brass assembly nut binds all parts.
- 10—Inner pole piece made of brass.

Write for circular RN-147 giving complete details.

**ROUWE Industries**  
1702 WAYNE ST., TOLEDO 9, OHIO





CBS Photo

**TELEVISION - *IT'S HERE!***

(Quoting—Television Broadcasters Association)

*Here's Your Opportunity to "get in on the ground floor" and prepare for great opportunities ahead*

**NOW—for the First Time, CREI Offers  
A Complete, Streamlined Home Study Course in**

**PRACTICAL TELEVISION ENGINEERING**

Here is the basic, practical type of engineering training that will qualify you for a "key" job in the expanding Television industry. Sooner or later you must face Television—as a problem, or as an opportunity. You can't rest on your past radio experience. But, you can use it as a firm foundation upon which you can add

greater knowledge and ability with the help of this new CREI home study course. It costs you nothing but a few minutes time to get complete details. Write at once for **FREE DETAILS** of the Television Engineering Course.

**CAPITOL RADIO ENGINEERING INSTITUTE**

**DEPT. RN-1, 16th and PARK ROAD, N. W., WASHINGTON 10, D. C.**

**Just off the press! Mail Coupon  
for complete Free Details and  
Outline of the Course**

If you have had professional or amateur radio experience and want to prepare for opportunities in TELEVISION, let us prove to you we have the training you need to qualify. To help us intelligently answer your inquiry—Please **STATE BRIEFLY YOUR BACKGROUND OF EXPERIENCE, EDUCATION AND PRESENT POSITION.**



**CAPITOL RADIO ENGINEERING INSTITUTE** RN-1  
16th and Park Road, N.W., Washington, D. C.

Please send me complete details describing the new CREI home study course in Practical Television Engineering. I am attaching a brief resume of my experience, education and present position.

Name .....

Street .....

City ..... Zone ..... State .....

CHECK  PRACTICAL RADIO ENGINEERING COURSE  PRACTICAL TELEVISION ENGINEERING

I am entitled to training under the G. I. Bill.

Member of National Home Study Council—National Council of Technical Schools—and Television Broadcasters Association

January, 1947



ments of the negative feedback resistor and the  $RC$  values. If this equipment is to be used for distortion measurements, a distortion check should be made to indicate that all adjustments are correct.

The design of the vacuum tube voltmeter is such that it will give linear response over the audio frequency range. Since the primary use of the meter is to simply indicate a constant level, no effort was made to calibrate it. The meter can be calibrated up to 6 volts, but above that voltage the scale no longer remains linear. By complicating the vacuum tube voltmeter circuit, a more accurate meter could be constructed. Time and expense did not justify such a procedure.

The cost of parts including chassis, panel, meter, variable condenser, tubes, etc., was \$53.25.

-50-

### Home Constructed V.T.V.M.

(Continued from page 35)

panel will require readjustment when switching the a.c. ranges, due to the contact potential of the diode  $V_1$ . If the zero adjusting screw on the face of the meter is properly set, zero adjustment of the pot should not be required when switching from minus or plus polarity with the polarity selecting switch.

For use with the d.c. voltmeter, a

probe with a one megohm resistor included in its tip should be provided to eliminate capacity loading on a circuit when a d.c. voltage is being measured, for instance, measuring the grid voltage of the oscillator tube in a superheterodyne without detuning the oscillator. If this feature is not desired, the one megohm resistor should be connected in the instrument in series with the 6 megohm resistor and ordinary test leads used. If r.f. voltages are to be measured with the a.c. input, leads should be kept as short as possible. If high r.f. is to be measured frequently, it is suggested that a 6H6 be arranged on a probe, to replace  $V_1$ , the diode rectifier, so that losses and detuning effects be reduced to a minimum. For all audio and power frequencies this is not necessary.

The power supply is conventional. A 40 mil receiver power transformer is adequate. The rectifier tube depends upon the filament windings available. If the transformer has only one filament winding of 6.3 v., then the rectifier should be a 6X5. If the transformer has a 6.3 v. winding and a 5 v. winding, then a 5Y3 or 80 may be used. The lower the high voltage winding is, the better, as 150 v. d.c. is all that is required. The 8000 ohm resistor which serves as a filter element together with the 2  $\mu$ fd. condenser may have to be adjusted in value to compensate for the d.c. output voltage of the transformer used. For indicating plates on the front panel, drawings can be made and photographic reproductions cemented to the front panel. In the interest of durability, they may be covered with thin lucite or cellophane.

Be sure that the binding posts or tip jack you use are properly insulated from the front panel. Insulation for about 1500 volts will provide a measure of safety.

When the unit is finished it will pay for itself many times over, particularly where voltages must be measured through high resistance. Actual uses include: receiver tune up (hook d.c. meter terminals to the a.v.c. voltage and tune for maximum indication); amplifier fidelity in FM receivers (an audio oscillator is connected to the amplifier under question and the gain of each stage is measured at 12,000, 400 and 60 c.p.s. Any serious discrepancy in response will be immediately apparent); measuring the d.c. grid voltage of tubes

Fig. 5. Reproduction of a scale for 3" meter. If this were expanded from its present width of 2" to 2 1/4" it could be used for your meter.

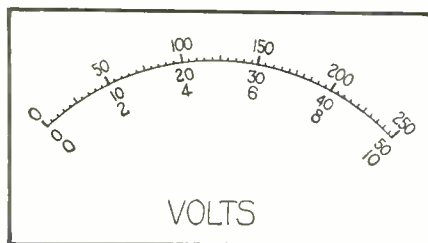

# Thanks for your Patience!

TUBES  
RELAYS  
CHOKES  
RESISTORS  
RECEIVERS\*  
CAPACITORS  
TRANSMITTERS  
TRANSFORMERS

1001  
BUYS

SURPLUS  
RADIO, INC.

30 MUNSON ST.  
PT. WASHINGTON, N.Y.

● We know you have been waiting patiently for your copy of the SURPLUS catalog. Now here it is, available to YOU!

Packed with the latest electronic components and equipment at prices a FRACTION OF ITS ORIGINAL COST.

All equipment strictly BRAND NEW and UNCONDITIONALLY GUARANTEED.

Are you on our mailing list? Send a postcard for your FREE Copy!

HERE'S AN  
EXAMPLE

UHF PRESELECTOR  
For the UHF GANG!

The Highest Gain Preselector Made! STOP DREAMING — HERE IT IS! The most efficiently designed unit of its type which has ever been made available to the amateur.

Complete with 3-GL446A tubes, spare parts, cables and sturdy wood carrying case.

Original cost \$275  
Your cost 39.50

All units Brand New.

FREQUENCY RANGE: 175 Mc. to 220 Mc.  
Easily adapted to cover the following bands: 224 Mc; 144 Mc; 54 Mc; 28 Mc.

FEATURES

- Extremely high gain.
- Two grounded-grid lighthouse stages.
- Tuned cathode and plate circuits.
- R.F. circuits individually shielded with silver-plated brass.
- Disk type vernier trimmers.
- National velvet vernier dials.

SURPLUS  
RADIO, INC.

30 MUNSON ST. Dept. C-1  
PORT WASHINGTON, N. Y.





ESTABLISHED 1906

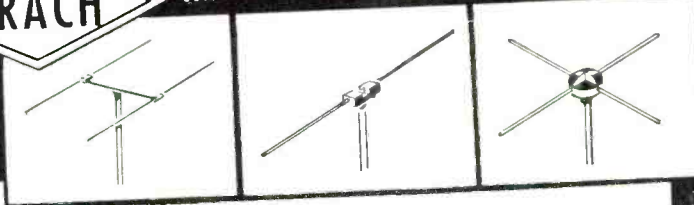

# ANTENNA SYSTEMS for USERS of PRIVATE BRANDS

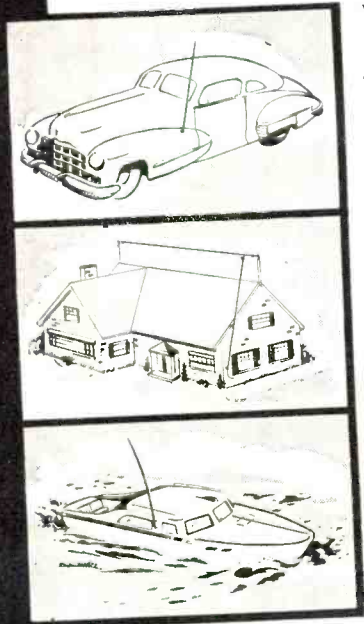

We manufacture the following, under private labels and trademarks:

**AUTOMOBILE ANTENNAS** . . . every variety, including types that can be raised and lowered from inside the car.

**RESIDENTIAL ANTENNAS** . . . AM and FM, for homes, stores and multi-family buildings. Complete lines of noise-reducing systems incorporating latest patented developments of coupling transformers.

**FM, AM and TELEVISION** . . . Dipoles with or without reflectors, folded dipoles, turnstile, radiating types and other combinations for roof, sidewall and other mountings.

**MARINE ANTENNAS** . . . Collapsible and transmitting types for every purpose.

**For POLICE and other mobile units** . . . roof-top antennas for ultra-high frequencies.

WE INVITE INQUIRIES AND CONSULTATIONS.

## L. S. BRACH MFG. CORP.

200 CENTRAL AVENUE NEWARK, 4 N. J.



WORLD'S OLDEST AND LARGEST MANUFACTURERS OF RADIO ANTENNAS AND ACCESSORIES

# PRE-EXAM TESTS FOR Commercial Radio Operator FCC LICENSE EXAMINATIONS

**DON'T TAKE A CHANCE—AVOID FAILURE ON FCC COMMERCIAL RADIO OPERATOR LICENSE EXAMINATIONS!**  
USE NILSON'S COMPLETE PRE-EXAMINATION TESTS AND COACHING SERVICE  
Enables You To

- Rehearse the FCC license examinations
- Practice the procedure
- Practice the multiple-choice examination methods used by FCC
- Check your knowledge
- Locate your weak points
- Correct your weak points before taking the actual examination

Prepared by Arthur R. Nilson, Famous Co-author of Nilson and Hornung's  
**RADIO QUESTIONS AND ANSWERS**  
Cleveland Institute of Radio Electronics, RN-1 Terminal Tower, Cleveland 13, Ohio

Cleveland Institute of Radio Electronics  
RN-1 Terminal Tower, Cleveland 13, Ohio  
Please send information about Pre-Exam Tests.

Name.....  
Address.....  
City..... Zone..... State.....

right at the grid (this is a good way to find leaky coupling condensers); and a thousand and one other uses, in addition to the conventional one of measuring voltages; all of which will repay you for building this vacuum tube voltmeter. -30-

## All-Purpose Signal Tracer

(Continued from page 37)

the switch type, to disconnect the speaker when the phones are plugged in.

The audio and radio frequency response may be seen from the curves given in Figs. 2 and 3. The values of the circuit constants in the grid of the 1T4 were purposely chosen to have the indicated low frequency response. If a large 60 or 120 cycle hum is superimposed on the signal, the hum frequency will not mask the higher signal frequency since it is attenuated by the high pass filter action. At the same time, the meter has full sensitivity at 400 cycles, which is the usual audio modulating frequency. The sensitivity remains flat in the audio and radio frequency range to 10 mc., above which resonance takes place in the tube and associated components; the sensitivity is increased until about 20 mc., and drops off sharply at higher frequencies.

Details of the physical construction of the unit may be seen from the photograph, Fig. 1. The entire equipment is mounted in a compact gray crackle cabinet containing all components, including the batteries. The 1T4 tube, .0002  $\mu$ f. condenser and 20 megohm grid resistor are housed in a drawn brass shielded probe with which any source point of r.f., i.f. or audio may easily be reached for testing, and which mounts on a bracket on the side of the cabinet when not in use. On the front panel are mounted the 4" speaker, the meter, a calibrated attenuator control for the amplifier, the balancing potentiometer for zero setting of the meter, on-off switch, speaker-meter switch, and the phone jack.

The combination of rapid visual as well as aural checking of the signal in this new design makes possible a more thorough testing of the signal from the antenna to the speaker, since the signal in each circuit may be heard for characteristics and fidelity as well as measured for relative strength. Any trouble in a receiver can easily and quickly be isolated. After the initial testing with the volt-ohm-milliammeter for the proper a.c. and d.c. operating voltages, the use of the signal tracer makes it a simple matter to locate defective r.f., i.f. and a.f. components. It becomes easy to find open, shorted or noisy resistors, capacitors, coils, and transformer windings. Bad or weak tubes are checked under actual operating conditions. The sources of intermittent operation, noise, hum, distortion, and any other faults are rapidly isolated. As an example, when testing for an intermittent defect in a receiver, the signal



MODEL 4704



## The Crown Princess

Satin walnut finish accented by an edge-lighted dial gives this new Air King radio-phonograph a beauty of appearance equalled only by the purity and naturalness of its tone. Styled with simple dignity, it fits naturally into any decorative scheme. Engineered by Air King, it wins the enthusiasm of the critical musician. Produced by Air King, its quality demands no penalty of price.

*Features that make the Crown Princess a superlative instrument include:*

Six tube (including rectifier) superheterodyne for standard broadcast. Two dual-purpose tubes give eight-tube reception. Automatic changer for

ten- or twelve-inch records. Permanent Alnico No. 5 magnet speaker. Featherweight, low-pressure tone arm. Permanent needle. Crystal pick-up. Automatic volume control. Full range tone control. Beam power output. Built-in loop aerial.



*The Royalty of Radio Since 1920*

# AIR KING RADIO

Division of HYTRON RADIO & ELECTRONICS CORPORATION, Brooklyn, N. Y.

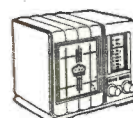
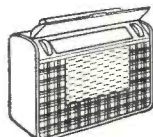
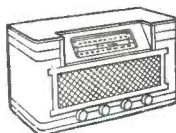
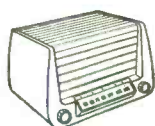

★ We have a limited number of distributor and dealer territories open ★  
January, 1947



# Radio Serviceman:

here's a valuable  
tool for your shop!

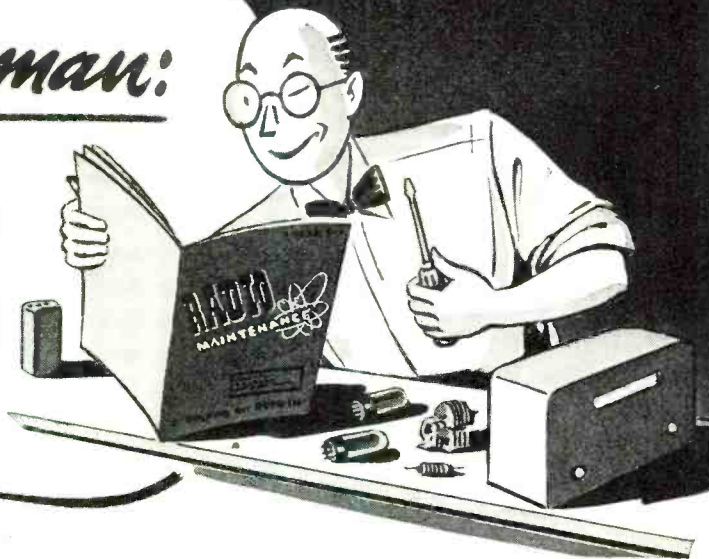

**RADIO  
MAINTENANCE**

**MAGAZINE** serves the Radio Service man with original articles on servicing techniques, educational articles on how to use all kind of test equipment, and "know-how" that will speed your servicing.

For example, each month we carry a special feature entitled, "The Radio Service Bench." Prepared by **Radio Maintenance** staff and readers, this department completely discusses the various problems of a radio shop such as tools, work bench, hints and kinks, and so on. Here we tell you not only what is needed but how, through your own ingenuity, your service jobs will go faster with more profit for you.

Of course, we go beyond the service bench. Each month, **Radio Maintenance Magazine** focuses attention upon all services which come under your jurisdiction. Trouble-shooting Procedures in AM-FM-Television; Public Address Systems; Alignment Problems—all are dealt with by well known men in the radio industry.

**Radio Maintenance Magazine** is a trade publication. You can't buy it on the newsstands. A one year subscription—twelve full months—costs only \$2.50.\* If you double up on two years, the cost is only \$4.00. Either way, you win in the long run.

Don't miss this valuable tool for your shop—this magazine that is published especially for you! Clip the coupon below and send it with your check to **Radio Maintenance**.

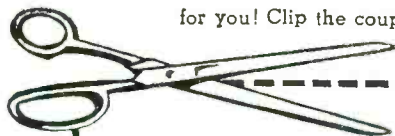

I enclose \$2.50 for 1 year     \$4.00 for 2 years    RN-1

RADIO MAINTENANCE MAGAZINE  
460 Bloomfield Avenue  
Montclair, New Jersey

NAME \_\_\_\_\_

ADDRESS \_\_\_\_\_

CITY \_\_\_\_\_ ZONE \_\_\_\_\_ STATE \_\_\_\_\_

Gentlemen:  
Please send me (one year's  
two years') subscription to  
**Radio Maintenance Magazine**  
as checked above.

NOT SOLD ON  
NEWSSTANDS

**RADIO  
MAINTENANCE**

460 BLOOMFIELD AVENUE • MONTCLAIR, N. J.

**BOLAND AND BOYCE, INC. - PUBLISHERS**

January, 1947

87





now you can

**SEE and HEAR** the signal  
with the new **CA-12**  
*Signal Tracer*



**Latest Superior Instrument product, featuring visible and audible signal detection...reducing the time to locate source of trouble to an absolute minimum. Simple to operate . . . only one connecting cable — no tuning controls. Complete with Probe, Test Leads, self-contained Batteries and Instructions.**

**Immediate Shipment! \$34.85**



**Model 450  
SUPERIOR  
TUBE TESTER**

"Speedy Operation" assured by newly designed rotary selector switch which replaces the usual snap, toggle or lever action switches.

Tests all tubes up to 117 volts including 4, 5, 6, 7, 7L, Octals, Loctals, Bantam Junior, Peanut, Television, Magic Eye, Hearing Aid, Thyratrons, Single Ended, Floating Filament, Mercury Vapor Rectifiers, etc. Also Pilot Lights. Net

**\$39.50**

**Model 650  
SIGNAL  
GENERATOR**

Improved AC-operated — generating RF frequency from 100 Kc to 105 Mc. Audio modulating frequency is 400 cycle pure sine wave. Three-step ladder — type alternator.



NET **\$48.75**

Write for bulletins and catalog of radio parts and equipment.

Terms: 25% deposit—Balance C.O.D.

**RADIO DEALERS SUPPLY CO.**  
135 Liberty St.  
New York 7, N. Y.

tracer may be left connected with the speaker switched on, and while other work is being done the set is at the same time constantly under test. In addition, the same simple procedure which is used in servicing broadcast receivers can be applied to the testing of all other types of communications circuits.

The unit described in this article has been designed and constructed with the purpose of making it the handiest and most conveniently operated instrument of its type. This signal tracer and a battery operated volt-ohm-milliammeter form a combination which may be used for servicing any type of communications equipment under almost any emergency conditions.

—30—

**Parasitic Beam Design**

(Continued from page 41)

tion, 2 lengths of tubing the same diameter as the elements, 33" long. The additional lengths are to take care of the portion through the center section.

It will be appreciated that, by substituting a wooden supporting mast, this array may be oriented to give vertical polarization. Further, with the array in the horizontal position, the feed line may be carried parallel to the 2 inch tube frame either toward the front or the rear for any desired distance and dropped down from that point. In this application it is to be recommended that the feeders clear the tube frame by at least 3 to 4 inches.

In connection with feeding beam arrays some controversy seems to exist as regards the delta match vs. the

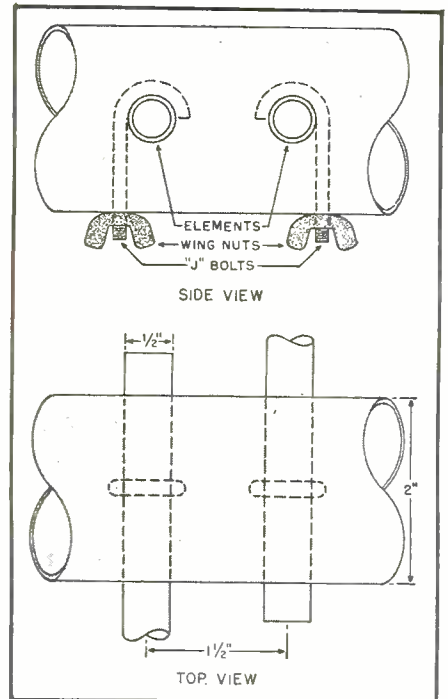

Fig. 4. Construction details for mounting and fastening the antenna elements.

"T" or other matching systems. In considering the efficiency of a feeder system it may be stated that the energy lost is equal to the energy delivered to the sending end of the line minus the energy delivered at the load end of the line. At the lower frequencies, the energy loss consists mainly of the I<sup>2</sup>R losses in the line, which manifest themselves as an unusable form of radiant energy, namely heat. As the operating frequency is increased, however, another type of loss must be added to the I<sup>2</sup>R loss.

Allen R. Richter, foreign sales manager of Press Wireless Manufacturing Corp., explains some of the features of the new 20,000 watt radio telegraph transmitter to S. L. Chang, radio engineer for the Central News Agency of China. The transmitter pictured is one of two such transmitters built by Press Wireless for the news agency. According to Chung-Chin Kao, former director of the radio division of the agency, the units are to be utilized mainly for radio telegraph, radio teleprinter, and radiophoto operation and will be coordinated with the Press Wireless international network and other communications organizations for the distribution of news.





# A MILLION *Relays!*

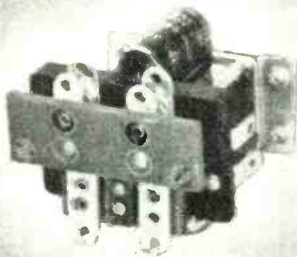
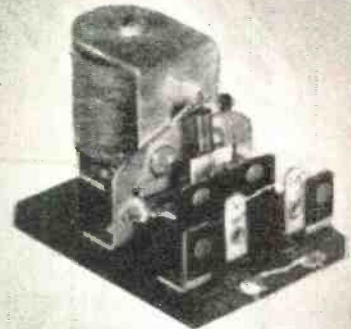
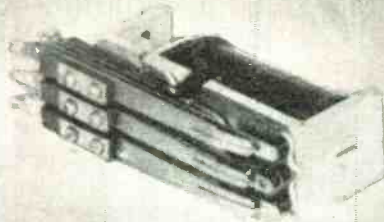
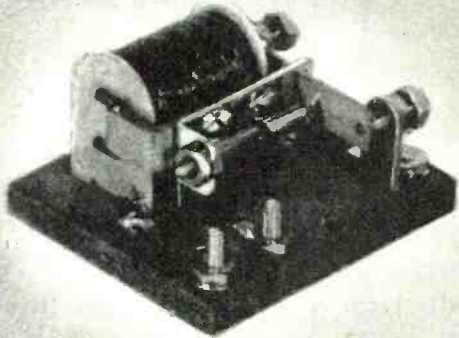

**Relays to Meet  
Practically Any  
Requirement**

**—AT GREAT SAVINGS IN COST**

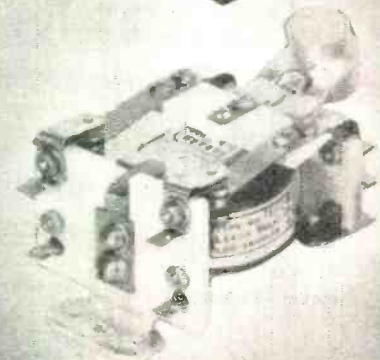

Our huge inventory of relays is, we believe, the largest and most complete in the country. These relays were made to exacting standards by America's leading manufacturers and are guaranteed in every respect. This equipment will meet your critical quality requirements and save you a large portion of the cost. Our new illustrated Relay Catalog is now ready and will be mailed upon request.

#### **Consult Wells for Quality Radio Parts**

We can make immediate delivery of a wide variety of radio components either singly or in quantity. Lists are available on the following items: Volume controls, condensers, resistors, phone jacks and plugs, wafer switches, Micro switches, transmitting tubes and Jones strips.

#### **Wells' Amateur Radio Division**

Smart amateurs everywhere are using Wells transmitter parts, tubes and equipment for best performance at the lowest possible cost. Write today for your copy of our Amateur Radio Catalog H-20C.



**Watch for Wells Parts Displays  
at Leading Jobbers**

**4717 W. MADISON ST., CHICAGO 44, ILL.**

WELLS SALES, INC., 4717 West Madison St., Chicago 44, Illinois, Dept. R-1

Please send lists or catalogs on items checked:

Volume Controls

Condensers

Amateur Catalog H-200

Relay Catalog

Resistors

Micro Switches

Phone Jacks and Plugs

Jones Strips

Transmitting Tubes

Wafer Switches

NAME .....

ADDRESS .....

CITY .....

ZONE .....

STATE .....



# THORDARSON *Amplifiers*

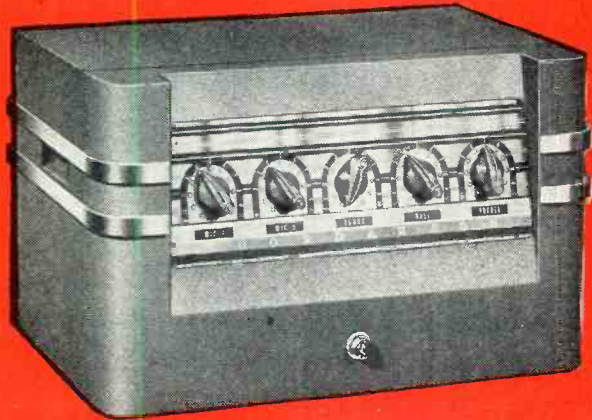

25 Watt Amplifier,  
Model T31 W25A



8 Watt Amplifier,  
Model T30 W08A

50 Watt Amplifier,  
Model T31 W50A



THORDARSON . . . MEISSNER . . . RADIART PRODUCTS  
LISTED AND RECOMMENDED BY PHOTO-FACT FOLDERS

THE *finest* IN

Insure natural, brilliant sound reproduction every time with this new Thordarson line. Backed by 51 years of outstanding transformer manufacture and 30 years of audio pioneering, these new units are the last word in amplifier quality . . . See them at your jobbers today . . . For sound to satisfy the experts, specify Thordarson.

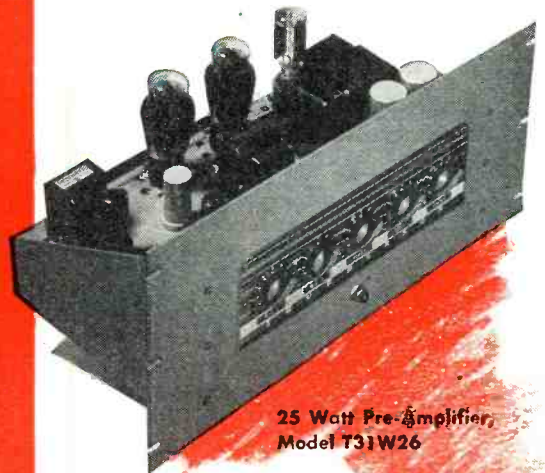

25 Watt Pre-Amplifier,  
Model T31W26

EXPORT SALES DIVISION  
**SCHEEL INTERNATIONAL**  
4237-39 N. LINCOLN AVE., CHICAGO 18, ILL., U. S. A.  
CABLE ADDRESS—HARSCHEEL

**ELECTRONIC  
DISTRIBUTOR**



# ELECTRONIC EQUIPMENT!

## MEISSNER

### SIGNAL SHIFTER

The top requirement for the complete "Ham Shack" Equipped with built-in band switching. No coils to change, six position switch. Choice of built-in or separate power supply. Ask your jobber for full information today.

### COILS

Completely dustproof, unaffected by humidity changes and unexcelled in stability, Meissner coils have been the standard of comparison for 24 years.

## RADIART

### VIBRATORS

Look for the Radiart Red Seal at your jobber's . . . Your guarantee of effective, trouble-free performance under all conditions. Radiart Vibrators are sealed against air and moisture to prevent point oxidation . . . a significant advance in vibrator design. Send for free catalog and vibrator guide.

### AERIALS

A complete line, cowl, hood and under-hood types, designed for all cars. Permanent "All-Metal Anti-Rattler" reduces mechanical noise and Plastic-Loom Lead facilitates maximum signal transfer efficiency. See this outstanding line at your jobber's today.

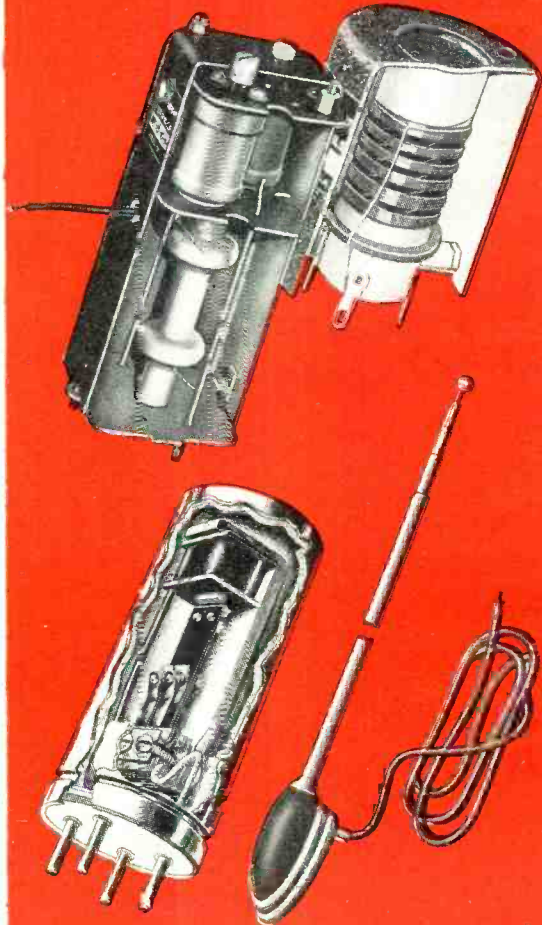

**MAGUIRE**  
**INDUSTRIES**  
INCORPORATED

**AND INDUSTRIAL SALES DEPARTMENT**  
936 N. MICHIGAN AVE. • CHICAGO 11, ILLINOIS



*Current  
Conversion  
with*  
**ATR**  
*Quality Products*



**ATR**  
**"A"**

**BATTERY ELIMINATORS**  
FOR CONVERTING A.C. TO D.C.  
New Models . . . designed for testing D.C. electrical apparatus on regular A.C. lines. Equipped with full-wave dry disc type rectifier, assuring noiseless, interference-free operation and extreme long life and reliability.

- Eliminates Storage Batteries and Battery Chargers.
- Operates the Equipment at Maximum Efficiency at All Times.
- Fully Automatic and Fool-Proof



**ATR**

**LOW POWER INVERTERS**  
FOR INVERTING D.C. TO A.C.  
Another New ATR Model . . . designed for operating small A.C. motors, electric razors, and a host of other small A.C. devices from D.C. voltages sources.

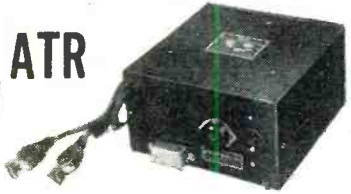

**ATR**

**STANDARD AND HEAVY DUTY INVERTERS**  
FOR INVERTING D.C. TO A.C.  
Specially designed for operating A.C. radios, television sets, amplifiers, address systems, and radio test equipment from D.C. voltages in vehicles, ships, trains, planes, and in D.C. districts.

WRITE FOR NEW CATALOG—  
JUST OFF THE PRESS!

**AMERICAN TELEVISION & RADIO CO.**  
Quality Products Since 1931  
ST. PAUL 1, MINN. U. S. A.

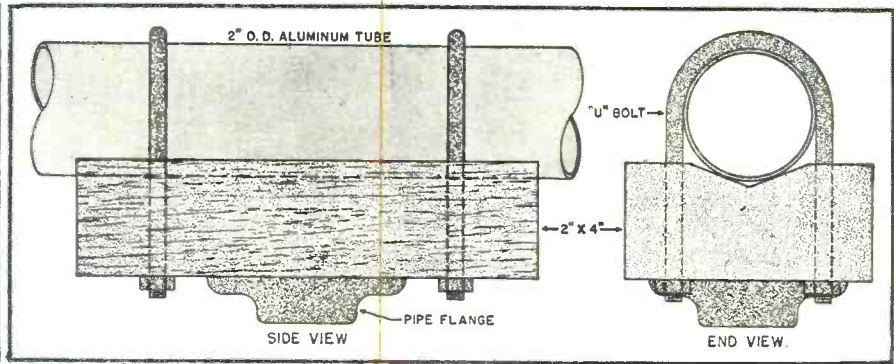

Fig. 5. An ordinary two by four is used to mount the main frame assembly to the mast.

This is the loss due to radiation. At the higher frequencies the spacing between the standard types of feed line becomes an appreciable part of a wavelength and the fields set up by opposing currents in opposing feeder legs do not positively cancel to the point where radiation is eliminated. Many amateurs undoubtedly have noticed a similar effect in high frequency tank circuits in which the minimum plate current dip seems high. Part of the high plate current is due to the fact that at these frequencies the radiation losses from the tank circuit decrease its impedance by lowering its *Q*. Parallel rod tank circuits minimize this effect because they carry currents

of equivalent magnitude and opposing direction at closely spaced distances, thus enabling cancellation and reduced radiation resistance.

In the delta match, this situation is aggravated by the fact that the legs of the delta are no longer close together and parallel. In a manner of speaking, it is now possible for the radiation fields generated by currents flowing in opposing legs of the delta to escape almost entirely, because they are at right angles to one another and cancellation is nullified. The resultant field from these two radiation components in all probability does not beneficially supplement the beam pattern or gain; therefore this energy

Technicians working quietly at their tasks at the Daven Laboratories in Newark, New Jersey were startled recently when an electrolytic condenser suddenly "blew its top." The can hit the ceiling with the speed of a bullet while paper and foil spiraled upward in a cloud of smoke. Walter Steinhard, Radio News Staff Photographer, reproduced the phenomena realistically with the original cast of parts.

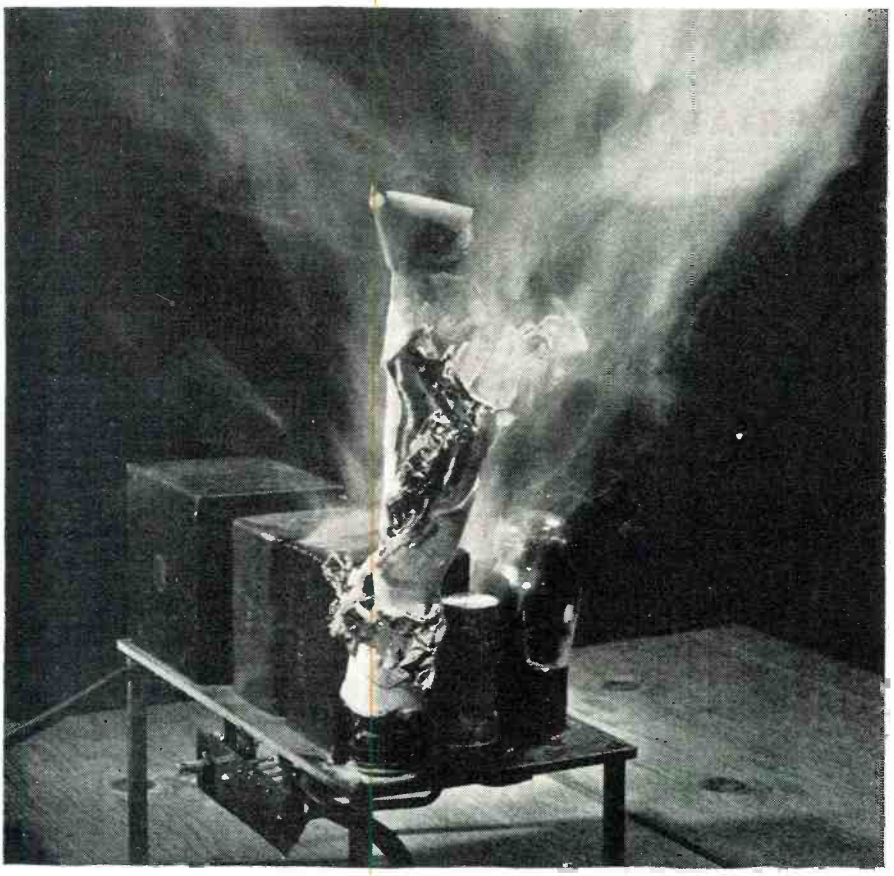



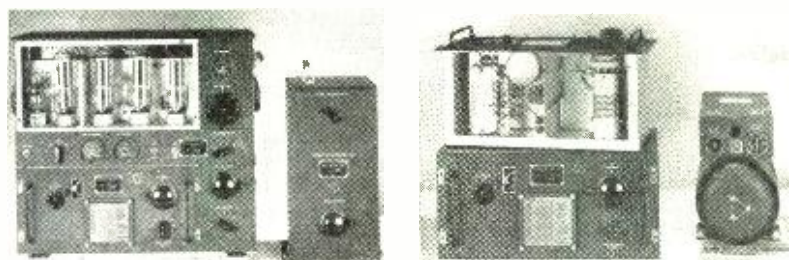

**General Electric 150-Watt Transmitter: Brand New!**

Cost the Government \$1800.00. Now Only \$44.50!!!  
(Can be used by amateurs without any changes or modifications!)

This is the famous transmitter used in U. S. Army bombers and ground stations during the war. Its design and construction have been proved in service, under all kinds of conditions, all over the world. The entire frequency range is covered by means of seven plug-in tuning units which are included. Each unit has its own oscillator and power amplifier coils and condensers, and antenna tuning circuits—all designed to operate at top efficiency within its particular frequency range. Transmitter and accessories are finished in black crackle, and the milliammeter, voltmeter, and RF ammeter are mounted on the front panel. Here are the specifications: **FREQUENCY RANGE:** 200-500 Kc. and 1500-12,500 Kc. (Will operate on 10 and 20 meter band with slight modification.) **OSCILLATOR:** Self-excited, thermal compensated, and hand calibrated.

**POWER AMPLIFIER:** Neutralized class "C" stage, using 211 tube, and equipped with antenna coupling circuit which matches practically any length antenna. **MODULATOR:** Class "B"—uses two 211 tubes. **POWER SUPPLY:** Supplied complete with dynamotor which furnishes 1000 volts at 350 milliamperes. Complete instructions are furnished to operate set from 110V AC. **SIZE:** 21 1/2 x 23 x 9 1/4 inches. Total shipping weight, 250 lbs., complete with all tubes, dynamotor power supply, seven tuning units, antenna tuning unit, the essential connector plugs, and two profusely illustrated instruction books, all in the original factory packing case. These transmitters are priced to move fast; quantities are limited! Order today, and be the proud owner of one of the finest rigs obtainable.

**14-Tube UHF Superheterodyne Receiver**

This beautifully constructed receiver was designed especially for Signal Corps communication service, and is one of the finest and most sensitive sets ever manufactured. Operating from 110V, 60 Cycles, this set has two tuned RF stages, tuned converter and oscillator, **FIVE Slug Tuned I.F.** stages, diode detector, tuning eye, and a two stage amplifier that will drive a speaker or phones. The frequency range is 158-210 Mcs. It is a simple matter to operate on other bands

by making a slight alteration in the tuning coils. A complete set of tubes is included with each receiver, along with a circuit diagram and parts list. The high-voltage power supply delivers 150 milliamperes, and is well filtered by a heavy-duty choke and three 7 Mfd. oil-filled condensers. This buy of a lifetime cost the government about \$700. Amateurs and experimenters will never again be able to purchase fine equipment at such a tremendous saving!.....Only \$39.95

**General Electric RT-1248 15-Tube Transmitter-Receiver**

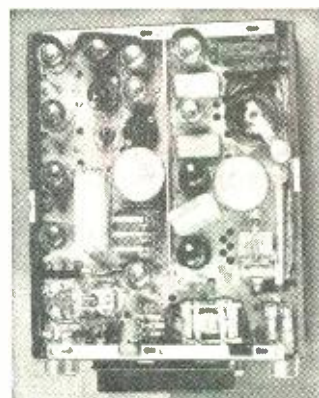

**TERRIFIC POWER** (20 watts) on any 2 instantly selected, easily pre-adjusted frequencies from 435 to 500 Megacycles. Transmitter uses 5 tubes including a Western Electric 316 A as final. Receiver uses 10 tubes including 95's as first detector and oscillator, and 3-7H7's as IF's, with 4 slug-tuned 40 MC. IF transformers, plus a 7H7, 7EB's, and 7FT's. In addition unit contains 8 relays designed to operate any sort of external equipment when actuated by a received signal from a similar set elsewhere. Originally designed for 12V operation, power supply is not included, as it is a cinch for any amateur to connect this unit for 110V AC, using any supply capable of 400V DC at 135 MA. The ideal unit for telephone use as in a taxicab, or for any kind of remote control applications as with drone airplanes. Instructions and diagrams supplied for running the RT-1248 transmitter on either code or voice, and for using the receiver as either an AM or FM set. As an FM set, the receiver section of the 1248 is capable of better results than almost any of the commercial FM sets on the market, largely as a result of the superb engineering and meticulous workmanship employed in constructing the converter, oscillator and IF sections.

Supplied in original cartons with 15 tubes. Your cost \$29.95. 10% less if ordered in lots of 2 or more. If desired for marine or mobile use, the dynamotor, which will work on either 12 or 24 V.D.C. and supply all power for the set, is only \$15.00 additional.

**BENDIX SCR-522**—Very High Frequency Voice Transmitter-Receiver—100 to 150 MC. This job was good enough for the Joint Command to make it standard equipment in everything that flew, even though each set cost the Gov't \$2500.00. Crystal Controlled and Amplitude Modulated—High Transmitter Output and 3 Microvolt Receiver Sensitivity gave good communication up to 180 miles at high altitudes. Receiver has 10 tubes and transmitter 7 tubes, including 2-832's. Furnished complete with 17 tubes. **ANO POWER SUPPLY** for 12 or 24 volts, also remote control boxes and cable connectors. We include complete diagrams and instructions for the simple conversion of the 522 to full 110 Volt 60 Cycle operation. Your cost, Brand New—\$44.50.

**Six Band Communications Receiver**

Featuring continuous coverage from 1500 KC to 18000 KC on a direct reading dial with the finest vernier drive to be found on any radio at any price—extreme sensitivity with a high degree of stability—crystal filter and phasing control—BFO—antenna compensation—transmit-receive relay—standard 6 volt tubes. Contains a plate supply dynamotor in compartment within the handsome

black crackle finish cabinet, the removal of which leaves plenty of room for installation of a 110V, 60 or 25 cycle supply. These new receivers, which make any civilian communications receiver priced under \$200.00 look cheap and shabby by comparison, are only \$44.50. Power supply kit for conversion to 110V, 60 cycle, is only \$8.50 additional.

**SERVICEMEN**

**Check This Column for Lowest Prices on Quality Parts**

- SPAGHETTI** and flexible plastic tubing. From 1/8" to 1" diameter. Any length you desire 3c a foot.
- SPEAKERS**—FM dynamic type—4"—\$1.95; 5"—\$2.05; 6"—\$2.20; 8"—\$3.95; 10"—\$5.95; 12"—\$7.50.
- CRYSTAL PICK-UPS**—Two nationally known makes, one at \$2.79, the other at \$3.43.
- PHONO-MOTORS**—110V 60 Cycle with turntable and high quality crystal pick-up—\$7.95.
- PHONO CABINETS**—Beautiful, portable leatherette covered with or without speaker grille—\$7.75.
- PHONO AMPLIFIERS**—A real AC 110V, 60 Cycle Amplifier suitable for PA systems and phono amplifier, with a husky power transformer. 6 Watts output. Complete with tubes—\$13.00.
- RECORD CHANGERS**—These are beauties—two post, with lightweight plastic and chrome pick-up, plays 10" and 12" records interchangeably! Complete with blue leatherette, or walnut stained cabinet, your choice. Ready for attachment to any radio at the give-away price of only \$24.95.
- RECORD PLAYERS**—Portable (Case, single record, complete with 6 Watt A.C. Amplifier previously described. Suitable for auditorium use—\$36.95.
- PUBLIC ADDRESS AMPLIFIERS**—25 Watts peak output, 5 tubes, separate controls for Microphone and Phono inputs. \$65.00 value for only \$32.00.
- CONDENSERS**—PAPER TUBULAR 600 WV—.001—8c; .002—8c; .005—8c; .01—9c; .02—9c; .05—10c; .1—10c; .25—23c; .5—36c; **ELECTROLYTICS**: 5mfd. 200v.—20c; 10mfd. 35v.—20c; 20mfd. 150v.—23c; 20/20mfd. 150v. 35c; 30/20mfd. 150v.—46c; 50mfd. 150v.—43c; 5mfd. 475v.—35c; 10mfd. 350v.—65c; **OIL-CONDENSERS**: 4mfd. 600v.—49c; **VARIABLE CONDENSERS**: 3 gang 250mfd.—83c; 7.5-20mfd. 1750v. Extra long shaft Hammarlund—only 69c; Miniature Variable condensers: 25mfd.—39c; 50mfd.—49c; 75mfd.—49c; 100mfd.—54c; 140mfd.—69c.
- PERMEABILITY TUNERS**—Attractive slide-rule dial, compactly replaces dial, tuning condensers, oscillator and antenna coils in broadcast band receivers. Special \$3.43.
- MICROPHONES**—All types, nationally known brands. Bullet crystal—\$5.45; Bullet Dynamic—\$7.45; Mike Jr.—60c; Handy Mike—90c; Lapel Mike—93c; other types at lowest price.
- TRANSFORMERS**—All types in stock. **AUTO-TRANSFORMERS**: Steps up 110v to 220v, or steps down 220v to 110v—\$1.95. **FIL. TRANS.**: 6.3v. 8 Amps.—\$1.98; 5v. 10 Amps.—\$1.98; 150MA. 600v. 6.3 & 5v. transf.—\$2.95; 45 MA 2.5v.—\$1.75; 50 MA-650v. 2.5 & 5v.—\$1.90; Universal Output Trans.—8 Watt—90c; 18 Watt—\$1.23; 30 Watt—\$1.69. **AUDIO TRANSFORMERS**: 8 Plate to 8 Grid. 3:1—79c; 8 Plate to P.P. Grids—79c; Heavy Duty Class AB or B, P.P. inputs—\$1.49; Midset Output for AC-DC sets—69c; **MIKE TRANSFORMER** for T-17 Shure microphone, similar to T-TC speaker type—\$2.00.
- RELAYS**—Guardian SPST 12-24v. has heavy duty 15 Amp. Contacts—\$1.25; Guardian 12 to 24v. D.C. triple make, single break relay, 5 for \$3.75; Sigma supersensitive 2000 ohm D.C. SPDT Relay. (May be adjusted to operate on less than 1 Milliampere)—\$2.50.
- SELENIUM RECTIFIERS**—Dry disc type 1 1/2" by 1", 1.2 Amp. maximum, suitable for converting DC relays to AC. For converting filament source in portable radios, converting DC meters to AC applications, and also may be used in low current chargers—90c.
- METER RECTIFIERS**—Full wave, may be used for replacement, or in construction of all types of test equipment—\$1.25. Half Wave—90c.
- FILTER CHOKE**—200, 300, 400, 500 ohm light duty—59c; 200 ohm heavy duty—99c; 250 MA, 35 ohms DC res. Made for U. S. Navy. Fully shielded—\$1.95.
- PLIERS KIT**—Khaki case with 4 alloy steel pliers of different designs. Flatnosed, pointed-nose, adjustable parrot-nose, and adjustable slip-joint. Brand new. Complete—\$2.08. Screwdriver type **SOCKET WRENCH KITS**—Handle with 9 attachable sockets—69c. **ALCOHOL BLOWTORCH**—99c.
- REPLACEMENT CABINETS**—Beautiful leatherette cabinet for portable radios—\$3.95. Silvertone model 4619, 9x10x16 1/2; model 4465, 5x10x8—\$1.50 each.
- CHASSIS**—ICA, Foundation chassis, and amplifier cabinets and chassis. Complete stock, order by ICA number. Lowest prices.
- WIRE**—No. 18 POSJ 2 conductor parallel zipcord, brown, 250' spools—\$5.25. 500' spools—\$9.95. No. 18 P0 brown rayon covered parallel lampcord, 500' spools—\$12.25. No. 18 SV round rubber covered double wire for wash machines, vacuum cleaners, etc. 250' spools—\$6.95. Rubber covered mike cable 250' Spools—\$25.00. All kinds hook-up wire—1 1/2c per foot.
- PORTABLE AIR COMPRESSOR**—Attaches to any 1/4 H.P. motor. Just the thing for refinishing radios, painting ears, blowing out chassis, etc. 100 lb. gauge and siphon type gun with 12 1/2 feet of rubber hose included. Pressure adjustable to stay constant at any value up to 100 lbs. Net price—\$22.50.
- VOLTMETER**—AC or DC. Hicock 0 to 150V. Almost linear scale (lowest scale division 10V.), with provision for sub-panel illumination—\$2.95.
- TUBES**: A warehouse full, including the new miniatures, order all types you need. We'll try to supply you completely. Special this month: Sylvania 6Y6GT—3 for \$2.00; RK-75 or 307 Transmitting tubes only \$2.50 each; 6LG—99c; 6SD7 (replaces 6SK7)—59c.

**A FREE SCREW DRIVER with All Parts Orders Over \$5.00**

**Famous Collins Autotune Transmitter**

This is the well known unit used in Army and Navy planes that features automatic motor tuning of any of 11 front-panel pre-selected frequencies up to 18,100 KC., as well as the manual tuning possible any time. The transmitter operates on voice, CW and MCW on all frequencies. This beautifully designed unit uses an 813 final, and push-pull 811's as modulator, measures 23 1/2 x 13 1/4 x 11, and weighs 70 lbs. Estimated average power output is 150 Watts. Price including dynamotor—\$185.00. Write for literature describing any units you wish more information on.

**OUR LATEST SPECIALS FOR SERVICEMEN, AMATEURS, AND EXPERIMENTERS**



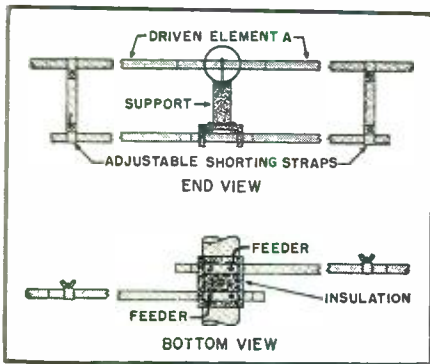

Fig. 6. Two views of "T" section show mechanical details of construction.

may be considered to be lost or wasted. In fact, the legs of the delta matching system are, in reality, a part of the antenna rather than a part of the feeder system, and are improperly polarized and improperly located with respect to the parasitic elements to benefit proper radiation.

In the "T" match, the long sections are close together, parallel and properly located so that spuriously polarized and directed radiation is minimized.

It is not claimed that a large difference in signal level would obtain over a long distance path between the two properly adjusted feed systems. However, it is accepted engineering procedure, when measured results are so difficult to obtain, to employ those practices which are sound.

-30-

### What's New in Radio

(Continued from page 66)

sists of an inverted converter (synchronous converter running from the d.c. side) with an amplidyne mounted on the same shaft. The amplidyne is connected in series with this inverter and bucks or boosts the voltage supplied by the axle-driven generator or battery to maintain constant a.c. voltage and frequency on the output side of the inverter.

The equipment is being manufactured by the Apparatus Department, General Electric Company, Schenectady, New York.

#### FACSIMILE RECEIVER

Persons attending the recent convention of the National Association of Broadcasters witnessed the first public

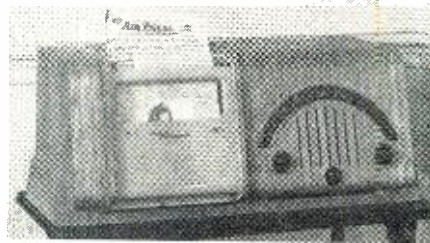

demonstration of the new Finch facsimile receivers for home use.

Available in table and console mod-

els, this modern facsimile recorder is combined with an FM-AM home receiver to provide complete home entertainment. The cabinets in which these models are housed are of specially selected woods.

The facsimile recorder is capable of scanning 28 square inches per minute at 105 lines per inch. The radio provides both standard and 88-108 mc. FM sound program reception.

This unit is being manufactured by Finch Telecommunications, Inc., 10 East 40th Street, New York 16, New York.

#### TUNABLE DIPOLE

A new type dipole for television and FM reception has been announced by Kings Electronics of Brooklyn, New York.

A unique feature of this dipole is the fact that the arms of the dipole are adjustable and can be resonated with the wavelength of weak stations. This eliminates ghosts and weak reception on certain stations in low areas, according to the manufacturer.

The adjustable feature of this dipole consists of a u.h.f. element that is calibrated from 1 to 21.5 in half steps. After facing the antenna in the direction of greatest signal strength, should any weak stations develop, this element can be moved in or out, according to a carefully calculated table, and then locked into position. This setting need be made only once.

Because of the adjustable element

# Fahnestock Clips

## RADIO'S GREATEST CONVENIENCE



### FAHNESTOCK SPRING BINDING POST GRIPS THE WIRE BY THE ACTION OF A SPRING

No tools required to make the connection. Grips the wire with just the right pressure for good electrical contact. Simply press down, insert the wire and let go. Does not injure wire, hence connection can be made or opened as often as desired. Available in large variety of types and sizes to fit any radio purpose and any requirement as to position, space or method of attachment. You will find them in the better sets.

Positive contact; cannot jar loose. Brass or bronze—nonrusting.



### FAHNESTOCK ELECTRIC COMPANY, Inc.

46-44 ELEVENTH STREET  
LONG ISLAND CITY 1, N. Y.

Dept. 12

Please send us at once, Descriptive Literature, Prices and Delivery Schedule on

### FAHNESTOCK CLIPS

For .....  
Name .....  
Address .....  
City ..... State .....



# A Handy Guide TO SPRAGUE EL SELF-MOUNTING MIDGET CAPACITORS (Can Type)

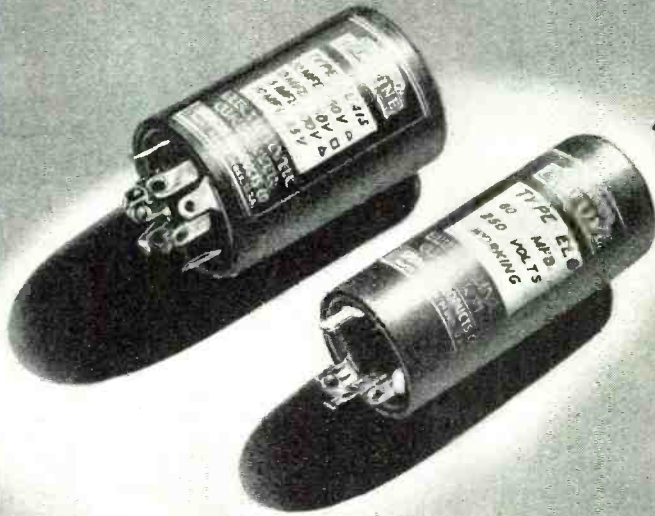

**Easier to install...  
Tops for Dependability**

Time is money in radio servicing. Save it—make more of it—by using Sprague Type EL can type dry electrolytic capacitors for every possible replacement use. They're small enough to fit anywhere. They're absolute tops in dependability. And you can mount them in a jiffy, either by direct chassis mounting or by means of their convenient twist prongs. Both bakelite and metal washers are supplied with each unit.

Ask for Sprague Type EL Capacitors by name!

# SPRAGUE

PRODUCTS CO., NORTH, ADAMS, MASS.

Jobbing Distributing Organization for Products of the Sprague Electric Company

January, 1947

### SINGLE SECTION

Catalog No.	Mfd.	Voltage DC working	Dimensions	
			D	L
EL-13	3000	10	1 3/8	3
EL-111	1000	15	1 3/8	3
EL-121	2000	15	1 3/8	3
EL-142	40	25	3/4	2
EL-112	100	25	3/4	2
EL-152	500	25	1	2 1/4
EL-122	1000	25	1 3/8	2
EL-50	150	50	3/4	2 1/4
EL-55	500	50	1 3/8	2 1/4
EL-31	30	150	3/4	2
EL-51	50	150	3/4	2 1/2
EL-14	40	200	1	2
EL-12	20	250	3/4	2
EL-30	30	250	3/4	2 1/4
EL-42	40	250	1	2 1/4
EL-6	60	250	1	2 3/4
EL-203	15	300	3/4	2
EL-33	30	300	1	2 1/4
EL-53	50	300	1	2 1/4
EL-123	125	300	1 3/8	3
EL-5	50	350	1	3
EL-125	125	350	1 3/8	3
EL-10	10	400	3/4	2
EL-20	20	400	1	2
EL-80	80	400	1 3/8	2 1/4
EL-1	10	450	3/4	2
EL-15	15	450	1	2
EL-2	20	450	1	2
EL-3	30	450	1	2 1/4
EL-4	40	450	1	2
EL-115	10	525	1	3

### DUAL SECTION

EL-242	40-40	25	1	2
EL-250	50-50	50	1	2
EL-221	20-20	150	1	2
EL-231	30-15	150	1	2
EL-230	30-30	150	1	2
EL-24	40-20	150	1	2
EL-35	50-30	150	1	2
EL-25	50-50	150	1	2
EL-26	60-60	150	1	3
EL-101	10-10	250	1	2
EL-120	20-20	250	1	2
EL-245	40-40	250	1	3
EL-21	10-10	300	1	2
EL-253	15-15	300	1	2
EL-22	20-20	300-25	1	2
EL-23	30-30	300-350	1	3
EL-32	30-20	350	1	3
EL-254	15-15	400	1	2 1/4
EL-214	80-10	400	1 3/8	2
EL-210	10-10	450	1	2 1/4
EL-151	15-10	450	1	3
EL-220	20-20	450	1	3
EL-240	40-40	450	1 3/8	3

### TRIPLE SECTION

EL-325	20-20-20	25	1	2
EL-335	30-30-30	50	1	2
EL-313	10-30-30	150	1	2
EL-320	20-20-20	150	1	2
EL-224	40-20-20	150	1	2
EL-340	40-40-40	150	1	3
EL-321	30-20-100	150-150-6	1	2
EL-222	20-20-20	150-150-25	1	2
EL-324	30-20-20	150-150-25	1	2
EL-332	30-30-20	150-150-25	1	2
EL-43	30-40-25	150-150-25	1	2
EL-343	40-30-20	150-150-25	1	2
EL-353	50-30-100	150-150-25	1	2
EL-352	50-50-20	150-150-25	1	2 1/4
EL-355	10-15-15	250	1	2
EL-315	10-15-30	250	1	2
EL-354	40-20-20	250	1	3
EL-331	15-15-20	250-250-25	1	2
EL-334	30-30-20	250-250-25	1	2 1/4
EL-314	10-20-30	250-250-350	1	3
EL-316	10-10-10	300	1	2
EL-333	20-20-20	300-300-25	1	2
EL-341	40-15-20	300-300-25	1	2 1/4
EL-102	10-10-20	350-350-25	1	2
EL-153	15-10-20	350-350-25	1	2
EL-326	15-15-20	350-350-25	1	2 1/4
EL-212	20-10-20	350-350-25	1	2 1/4
EL-323	30-20-20	350-350-25	1	3
EL-311	10-10-10	400	1	2 1/2
EL-342	15-15-40	400-400-25	1	2 1/4
EL-322	20-20-20	400-400-25	1	3
EL-310	10-10-10	450	1	2 1/4
EL-344	15-15-10	450	1	3
EL-362	20-15-10	450-300-300	1	3
EL-363	10-10-20	450-350-25	1	2
EL-364	15-20-20	450-350-250	1 3/8	2
EL-345	10-10-10	450-450-25	1	2
EL-202	10-10-20	450-450-25	1	2
EL-312	10-20-20	450-450-25	1	3
EL-353	15-15-20	450-450-25	1	3
EL-205	20-15-20	450-450-25	1	3
EL-350	20-20-20	450-450-25	1	3
EL-330	30-30-20	450-450-25	1 3/8	2 1/4
EL-360	15-15-10	450-450-300	1	3
EL-215	15-5-15	450-450-350	1	3

### QUADRUPLE SECTION

EL-434	30-30-30-40	150-150-150-25	1 3/8	2
EL-443	40-40-30-20	150-150-150-25	1 3/8	2
EL-452	50-50-50-20	150-150-150-25	1 3/8	2
EL-422	40-20-10-20	200-200-200-25	1 3/8	2
EL-412	10-10-10-20	300-300-300-25	1 3/8	2
EL-432	40-40-20-20	350-300-300-25	1 3/8	2
EL-415	20-10-5-10	350-350-350-25	1 3/8	2
EL-442	20-20-20-20	400-400-400-25	1 3/8	2 1/4
EL-410	10-10-10-10	450	1 3/8	2
EL-420	20-20-20-20	450	1 3/8	3
EL-421	20-15-15-20	450-350-350-25	1 3/8	2
EL-423	20-15-20-20	450-450-25-25	1 3/8	2
EL-425	20-20-30-30	450-450-300-300	1 3/8	3
EL-431	10-10-10-20	450-450-450-25	1 3/8	2
EL-424	40-30-10-20	450-450-450-25	1 3/8	3



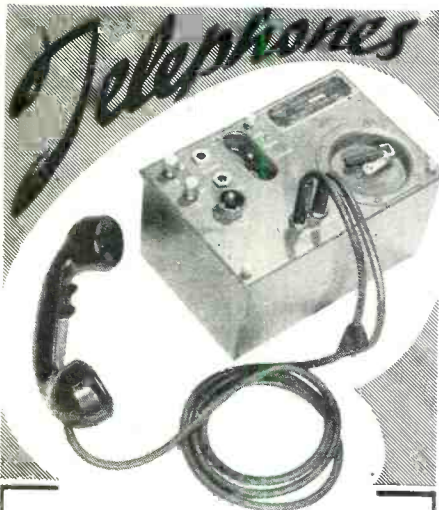

Self contained magneto ringing telephones with French type handset. Complete as shown with microphone battery and heavy canvas carrying case. Saves thousands of steps and valuable time.

- \* on broadcast remotes
- \* on construction jobs
- \* between farm buildings
- \* from store to warehouse or yard
- \* relaying information in public address work

No outside power required. Easily moved from one location to another. Operate several stations on one pair of wires. These units are brand new Army surplus. Supply is limited—don't delay—send your order in at once.

Stock No. A-744. Price per station ..... **\$14.95**

# SREPCO

STANDARD RADIO & ELECTRONIC PRODUCTS CO.  
135 East Second Street, Dayton 2, Ohio

this dipole is capable of receiving an extremely broad band of FM and television frequencies, including black and white, color and experimental television; FM; 1 1/4 meter amateur; glide paths; airport controls; and fixed and mobile stations.

Kings Electronics, 372 Classon Avenue, Brooklyn 5, New York will supply prices and additional details upon request.

### PORTABLE SOUND SYSTEM

Newcomb Audio Products Company of Los Angeles has developed a new portable sound system, one of a series

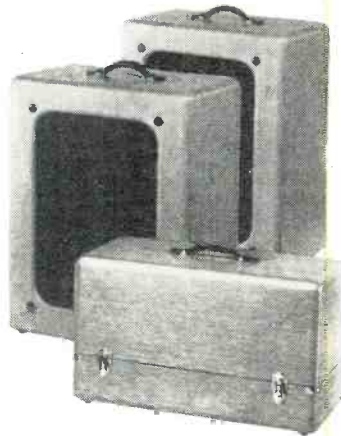

of portable units built around the standard and deluxe Newcomb amplifiers, and ranging from 10 to 60 watts power output.

The 3-case system includes a 30 watt amplifier with two 12", wide range loudspeakers. The cases are of plywood with airplane type fabricoid finish. Each speaker is supplied with 50 feet of detachable cable.

The combined shipping weight of the Model KX-30R12A is 147 pounds.

Complete information of this unit will be supplied by Newcomb Audio Products Company, 2815 S. Hill Street, Los Angeles 7, California, to those requesting it.

### V.T.V.M.

The Type 1800-A vacuum tube voltmeter is the newest addition to the line of test instruments offered by General Radio Company of Cambridge, Massachusetts.

This unit is smaller, lighter and easier to use than the company's Type 726-A which this model supersedes. In addition, the v.t.v.m. reads d.c. as well as a.c. voltages and can be used at much higher frequencies.

The range of a.c. voltage measurement is .1 to 150 volts. Frequency correction curves for both resonance and transit-time effects for frequencies up to 500 mc. are supplied. Where absolute voltage readings are not required, the instrument can be used as a voltage indicator up to 2500 mc. A single zero setting serves for all ranges. The d.c. voltage range is between .01 and 150 volts. The rated accuracy for both a.c. and d.c. measurements is ± 2%.

The probe is supplied with a variety

## CAST ALUMINUM CALL LETTER PLATES

For Broadcasters

For Hams



SHURE  
55, 555, 556



WE  
633A



RCA  
74B



TURNER  
U9S, 99, 999

### MICROPHONE NAMEPLATES

Cast of aluminum with letters and borders raised (front and back) and satin finished. Background, baked black crackle enamel. Sideplates furnished with call letters or affiliation letters. Special color backgrounds 40c extra. Special Paint combinations \$1.00 extra. Letters may be cast inverted for boom suspension at no extra cost.

SHURE 55, 555, 556, with side plates .....	\$12.00 ea.
WESTERN ELECTRIC 633-A, less side plates .....	7.50 ea.
RCA-74B, less side plates .....	7.50 ea.
RCA-74B, with side plates .....	10.50 ea.
TURNER U9S, 99, 999, less side plates .....	7.50 ea.
TURNER, U9S, 99, 999, with side plates .....	10.50 ea.

The above are only a few of the types available. Write for complete information.



### VERTICAL STAND PLATES

Type A-22--2 3/4" x 8 1/4". Equipped with brackets for fastening to mike stand. **\$3.00** Each

Type A-24 — Same as A-22 but with affiliation letter across top. **\$3.50** Each



### AUTO PLATE

Type A-16 Auto Plate with affiliation letters at each end. **\$3.00** Each



**\$2.50**

Add 20c for Packing and Postage

### FOR YOUR CAR — Type A-18

Cast with brackets for auto mounting and two 6-32 x 3/8" threaded studs for panel mounting.

### FOR PANEL MOUNTING — Type A-19

Same as above, but without auto brackets. Equipped with studs for panel mounting.

Dimensions 2 3/4" x 8 1/4" with 1 1/2" high letters.

These large sturdy plates are cast of aluminum with letters and borders raised and satin finished. Background, baked crackle enamel. Black is standard—red, gray or blue 40c extra. Price includes up to five letters. Add 15c for each letter over five.

Actual Size



### LAPEL BUTTONS

Type A-26 — Expertly etched with letters raised, sharp and clear, and highly polished. Screw type backing for lapel.

**\$1.00**

Type A-18 Auto Plates, A-19 Panel Plates and A-26 Lapel Buttons supplied with broadcast calls at same prices as listed for hams.

# SREPCO

STANDARD RADIO & ELECTRONIC PRODUCTS CO.  
135 East Second Street, Dayton 2, Ohio

Add 10c for Packing and Postage



# SYLVANIA NEWS

## RADIO SERVICE EDITION

JAN.

Prepared by SYLVANIA ELECTRIC PRODUCTS INC., Emporium, Pa.

1947

# ONE DEVICE NOW USED BY RADIO SERVICEMEN FOR GREAT VARIETY OF TESTS

## Electrical Measurements Made Easy With New Sylvania Unit!

### The SYLVANIA Poly (MULTI-PURPOSE) Meter

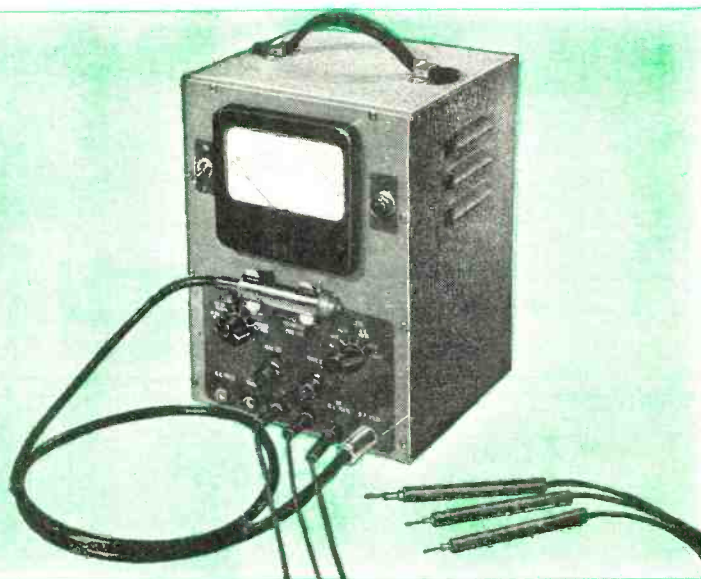

Radio servicemen now can use the new Sylvania Poly (MULTI-PURPOSE) Meter type 134 to facilitate a multitude of electronic measurements and tests to radio equipment.

This product of Sylvania Research is stabilized against errors due to voltage variations or gas current in tubes. All accessories included. See your Sylvania Distributor.

#### CHARACTERISTICS AND SPECIAL FEATURES

Tests audio, A.C. and R.F. voltages from 20 cps to 300 mc through use of proximity fuze-type tube built into handy probe. Full scale range of 3, 10, 30, 100, 300.

Measures D.C. from .1 to 1,000

volts in full scale ranges of 3, 10, 30, 100, 300, 1,000.

Measures D.C. current from .1 milliamperes to 10 amperes in full scale ranges of 3, 10, 30, 100, 300, 1,000 milliamperes and 10 amperes.

Measures resistance from  $\frac{1}{2}$  ohm to 1,000 megohms in full scale ranges of 1,000, 10,000, 100,000 ohms and 1, 10, 1,000 megohms.

#### ACCURACY

D.C. ranges  $\pm 3\%$  of full scale.

A.C. ranges  $\pm 5\%$  of full scale up to 30 volts and  $\pm 7\%$  above 30 volts.

R.F. ranges  $\pm 5\%$  of full scale up to 10 volts;  $\pm 7\%$  from 10-100 volts;  $\pm 10\%$  on 300 volt range.

Ohms  $\pm 6\%$  to the left of  $\frac{1}{2}$  scale;  $\pm 13\%$  to the left of  $\frac{3}{4}$  scale.

Current  $\pm 3\%$  of full scale on all but 10 ampere scale which provides  $\pm 5\%$  of full scale.

#### INPUT IMPEDANCES

R.F. ranges—2.7 megohms resistance shunted by approximately 3 mmf. capacity.

A.C. ranges—2.7 megohms resistance shunted by approximately 40 mmf. capacity.

D.C. ranges—16 megohms resistance. Remember the Sylvania Poly (MULTI-PURPOSE) Meter type 134. It's beautifully styled, compactly designed, has easily read meter and dials.

# SYLVANIA ELECTRIC

Emporium, Pa.

MAKERS OF RADIO TUBES; CATHODE RAY TUBES; ELECTRONIC DEVICES; FLUORESCENT LAMPS, FIXTURES, WIRING DEVICES; ELECTRIC LIGHT BULBS



# — SET BUILDERS — TWO-TUBE SUPER HET KIT

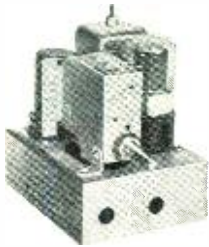

Upright model

Laydown model where space is essential

Completely wired ready to connect into any AC-DC or 6 volt filament with 125 V or more B supply —plate current drains—2 mls. . . . . **\$795** ea. unwired

High gain and selectivity—plays with 6 ft. of wire—excellent for PA systems, radio tuners and for making combination kits for set builders—tunes police calls . . . . . **\$995** ea. wired



Escutcheon plate with knobs as illustrated goes with each unit—wired or unwired.

**Consists of:**

- 1 312-1 Perm. Tuners
- 1 322-2 I.F. Coils
- 1 263-5034-4 Tub. Cond. .05 mfd.
- 2 263-1034-5 Tub. Cond. .01 mfd.
- 1 232-2515-2 Mica Cond. 250 mmf.
- 1 232-5015-4 Mica Cond. 470 mmf.
- 1 232-5015-3 Mica Cond. 500 mmf.
- 1 111-22312 1/2 W. C a r b. Resistor. 22K
- 1 111-33512 1/2 W. C a r b. Resistor. 3.3M
- 1 111-10612 1/2 W. C a r b. Resistor. 10M
- 1 111-27412 1/2 W. C a r b. Resistor.
- 2 270K Sockets
- 2 727A1 Tube Shields
- 1 571-3 Tube Clips
- 1 chassis
- 1 12SA7
- 1 12SQ7
- 1 Vol. Control
- 1 phono switch
- 1 on-off switch
- 2 knobs
- 1 escutcheon plate

Quantity unlimited  
20% deposit with orders

**UNION Radio Corporation**  
328 S. Paulina • Chicago 12, Ill.

Immediate delivery, Dept. A

of fittings, including both coaxial and banana-plug terminals and a 50 ohm disc resistor for coaxial line measurements. The probe cap is removable to give a minimum input capacitance of



3.1  $\mu$ fd. The input resistance at low frequencies is 25 megohms, decreasing at higher frequencies owing to loss in the shunt capacitance. Two input resistances are available for d.c. measurements, 10 megohms and open grid. Power supply for this unit is 100 to 130 or 200 to 260 volts, 50 or 60 cycles. A voltage regulated power supply is used.

Prices and additional details will be furnished by *General Radio Company*, 275 Massachusetts Avenue, Cambridge 39, Massachusetts.

**FLASH TUBE**

*Sylvania Electric Products Inc.* has recently announced the availability of a new electronic flash tube which provides increased light output and has been specially designed for black and white and color photography.

This new type R4340 tube provides a peak output of 48 million lumens or four times the amount of light produced by the type R4330 previously announced by the company.

Daylight quality of the light, which produces an almost flat curve between

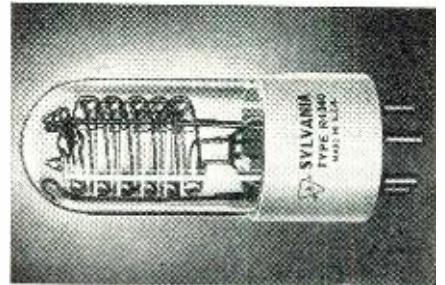

4000 and 7000 angstroms, makes it suitable for color photography where both intensity and color characteristics are important.

Tube life is rated at more than 10,000 flashes with a maximum repetition rate of four times a minute. This tube is suitable for condenser discharge circuits where a 120  $\mu$ fd. condenser is discharged at 2500 volts. These circuit values provide a flash of approximately 1/5000th of a second duration.

Further information on the type



**PICK-UP**

.. AS QUICK AS A WINK .. WITH ..

*Smooth Power*

Not a word or a note need be missed when your record players, record-changers or recorders are equipped with *Smooth Power* motors. That's because these units are built for split-second pick-up to full constant speed.

Their quietness and freedom from vibration give smooth performance that will delight your customers. From our complete line of *Smooth Power* phonomotors, recorders and combination record-changer recorders, you can select exactly the right units to match your own fine products.

**NOTE TO INDIVIDUAL USERS**  
Smooth Power Motors are sold only through established trade channels.



Model GI-RM4 Smooth Power Recording Motor

**THE GENERAL INDUSTRIES CO.**

DEPT. MR • ELYRIA • OHIO



*Brand New*  
STANDARD BRAND  
**TUBES!**  
UP TO  
**80% OFF**

**WAR SURPLUS EQUIPMENT!**

... AT A FRACTION OF THEIR ORIGINAL GOVERNMENT COST!



**AIRCRAFT INTER-COM AMPLIFIER**

Comes completely wired in aluminum cabinet with the following: 2—12A6, 2—12J5 Tubes, 1—Bath tub condenser, 3—Can Filter Condensers, 12—Precision Resistors, 6—Mica Condensers, 4—Low loss octal Sockets, Shielded input and output Transformers, 2—shielded R.F. chokes, 1—S.P.S.T. toggle switch, 28 V D.C. Dynamotor. Sun Radio furnishes the instructions for easy conversion to Hi-fidelity phono or **\$8.95** speech amplifier. ....



**R.F. TUNING UNIT**  
**\$3.89**

Comes in a beautiful black crackled aluminum cabinet with two Variable Transmitting Condensers and two Vernier dials, one heavy duty ceramic four position wafer switch, two or more mica condensers 2,500 Working Volts and coils wound on porcelain ribbed forms.

- No. TU5B—1500 to 3000 KC
- No. TU6B—3000 to 4500 KC
- No. TU7B—4500 to 6200 KC
- No. TU8B—6200 to 7700 KC
- No. TU10B—10,000 to 12,500 KC

Please specify model

Number	Price	Number	Price	Number	Price
0Z4	\$ .45	6F5	\$ 1.00	12SA7GT	\$ 1.30
1A5GT	1.00	6F6	.95	12SF5GT	1.00
1A6	.80	6F7	1.50	12SJ7GT	1.10
1B4	.80	6G6	1.00	12SK7G7	1.10
1B7	.80	6H6	.75	12SL7GT	2.20
1C5GT	1.00	6J5	.80	12SN7GT	.95
1D7	.85	6J7	1.15	12SQ7GT	1.10
1D8GT	1.10	6J8	1.30	12SR7	1.00
1E4	.80	6K6	.85	14A7	.50
1E5	.90	6K7	.85	14B6	.40
1E7	1.00	6K8	.30	14B8	.60
1F4	.80	6L5	1.10	14C5	.60
1F5	.90	6L6G	.50	14C7	.60
1F7	.90	6L7	.40	14F7	.60
1G4	1.30	6N7	.40	14H7	.60
1G6	1.25	6P5	.80	14J7	.60
1H4	.70	6P7	.40	14N7	.60
1H6	.80	6Q7	.40	14Q7	.60
1J5	.80	6R7	.40	14S7	.60
1J6	.85	6S7	.40	14W7	.85
1LA4	.95	6SA7	1.00	14Y4	.60
1LB4	.95	6SF5	.70	18	.25
1LC5	.95	6SJ7GT	.70	19	1.00
1LD5	.95	6SK7GT	.80	20	.75
1LH4	.95	6SL7GT	.80	21	1.00
1LN5	.95	6SN7GT	.85	22A	.90
1N6	.80	6SQ7GT	1.00	26	.75
1R5	.25	6T7	1.00	27	.70
1S4	.25	6G5	.95	30	1.00
1S5	.25	6U6GT	1.00	31	1.00
1T4	.25	6U7	1.00	33	1.00
1T5	.50	6V6	1.10	34	.80
2A6	.75	6W7	1.00	35/51	1.00
2A7	.65	6W7	.20	35/24	.80
2B7	.75	6X5GT	1.00	36	1.00
2E5	.65	6Y6G	1.00	37	.75
2X2 879	.90	7A4	1.00	38	.85
2Z2 684	.95	7A5	1.00	39/44	.85
3A8	.25	7A6	1.00	41	.85
3S4	.25	7A7	1.00	45	.80
5U4	1.00	7B4	1.00	46	1.00
5V4	.60	7B5	1.00	49	.95
5X4	.70	7B6	1.00	50	1.75
5Y3GT	1.10	7B8	1.00	55	.80
5Y4	.75	7C5	1.00	56	.80
5Z3	.95	7C7	1.00	59	.80
6A5	1.70	7E6	1.00	76	.75
6A6	.80	7E7	1.30	77	.75
6A8	1.00	7F7	1.30	78	.85
6A5G	1.70	7H7	1.50	79	.85
6AC5GT	1.00	7I7	1.50	80	.60
6AF5	1.00	7L7	1.50	81	1.50
6AF6	1.60	7N7	1.50	82	.85
6B4	1.50	7Q7	1.00	83	1.30
6B7	.95	7R7	1.30	83V	1.95
6B8	1.00	7S7	1.30	89	.40
6C5	.95	7W7	1.80	99	1.50
6C6	1.00	7Y4	.30	117L7GT	2.35
6C7	.45	7Z4	1.30	117Z6GT	1.60
6C8	1.25	12A5	1.50	XXB	1.50
6D6	.75	12F5GT	1.00	XXFM	1.50
6D7	1.00	12J5GT	1.00	XXL	1.50

An additional 10% discount will be given on all orders for 100 tubes or more!



**SPEAKERS**

Navy Type waterproof speakers Stromberg-Carlson and RCA 4 1/2" reentrance trumpet with 25 Watt PM driver unit and line matching transformer, \$125 value for \$32.50. 25 Watt PM driver unit with line-matching transformer and waterproof projector mounted in a heavy duty round metal baffle. Ideal for communication receivers and public address systems at the lowest price ever offered! **\$14.95**



**LOW FREQUENCY RECEIVER BC-344**

Brand new, operates on 110 volts A.C. complete with 10 tubes, 6" P.M. speaker, encased in metal baffle . . . tunes 150 to 1500 KC. A "hot" low frequency receiver at this spectacularly low price . . . **\$85.60** only

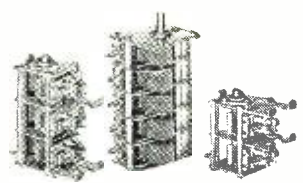

**TUNING CONDENSERS**

Beautifully designed with ceramic insulation.

- 2 gang, split stator, 36 mmfd. . . . . **\$1.49**
- 3 gang, split stator, 36 mmfd. . . . . **\$1.99**
- (Easily converted to 365 mmfd. per section)
- 5 gang, 365 mmfd. per section . . . . . **\$2.95**

The greatest value ever offered in tuning condensers! **Additional 10% discounts in lots of 12 or more**

**GARRARD RECORD CHANGER**

RC/60 110 V.A.C. operation 50/60 cycles intermixes 10 and 12 inch records, automatically cuts off after last record, variable speed motors, comes with new permanent needle with less than one oz. needle pressure. . . . . **\$63.00**

Universal model same as above but operates AC 110/130 and 200/250 volts. **\$73.00**

Walnut Wood Cabinet for above \$24.00

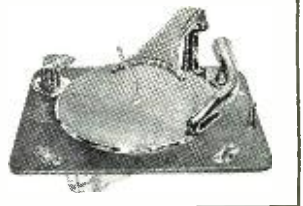

**F.M. TRANSMITTER & RECEIVER**

BC 683—FM—10 tube receiver less power supply . . . . . **\$39.95**

BC 684—FM—35 Watt Transmitter less crystal and power supply. . . . . **\$39.95**

Combination BC 683-and BC 684 Tunes 27 to 38.9 MC. . . . . **\$69.95**

**PROVAC V.T.V.M.**

This beautiful V.T.V. Meter that has met the demands of thousands of Radio engineers and servicemen.

DCV Ranges 0 to 3-10-100-300-1000. 11 Meg. ohm input resistance 3% ± ACV Range 0 to 10-30-100-300-1000. 1000 ohms per volt. R. F. Range. 0 to 3-10-30-50 Frequency range 60 CPS to 100 Mcycles ohm Meter Range 0 to 1000-10,000-100,000; 1 meg.-10 meg-1000 meg. Complete . . . . . **\$59.50**

**GON-SET CONVERTERS AM & FM**

AM

- 20 meters . . . . . **\$39.95**
- 10 and 11 meters . . . . . **39.95**
- 6 meters . . . . . **39.95**
- Special-Noise-silencer . . . . . **8.25**

FM New Bands

- 88 MC to 96 MC
- 96 MC to 104 MC
- 100 MC to 108 MC

**\$14.95**

**SCR-195**

New Walkie Talkies SCR-195 tunes 52.8 to 65.8 MC. 2 units complete and ready to operate . . . . . **\$119.90**

**WESTON No. 689 OHM METER**

Scale 0-10-1000 Scale to read 1/20 ohm Complete with leather case. . . . . **\$14.97**

**SUN RADIO**  
OF WASHINGTON, D. C.  
938 F STREET, N. W. WASH. 4, D. C.

**ALL ITEMS F.O.B., WASHINGTON, D. C.**  
All orders \$30.00 or less cash with order. Above \$30.00, 25 percent with order balance C.O.D. Foreign orders cash with all orders plus exchange rate.



**7 DAYS  
FREE EXAMINATION**

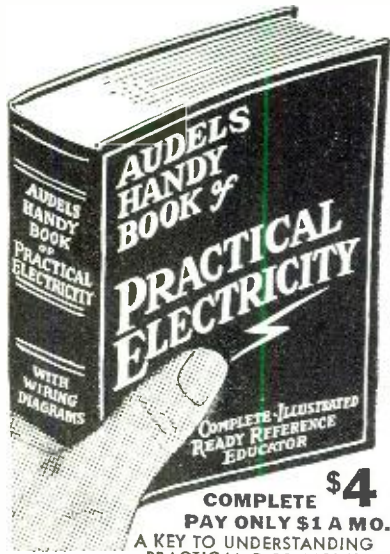

Audels Handy Book of Practical Electricity for Maintenance Engineers, Electricians and All Electrical Workers—1440 Pages, 2600 Illustrations. A quick, simplified, ready reference book, giving complete instruction and practical information on the rules and laws of electricity—maintenance of electrical machinery—A.C. and D.C. motors—armature winding and repair—wiring diagrams—house lighting—power wiring—cable splicing—meters—batteries—transformers—elevators—electric cranes—railways—bells—sign flashers—telephone—ignition—radio principles—refrigeration—air conditioning—oil burners—air compressors—welding and many modern applications explained so you can understand. All indexed for ready reference. Step up your own skill with the facts and figures of your trade. Audels Mechanics Guides contain Practical Inside Trade Information in a handy form. Fully illustrated and easy to understand. Highly endorsed. Check the book you want for 7 days' Free Examination.

Send No Money. Nothing to pay postman.

**CUT HERE**  
**MAIL ORDER**

AUDELS, Publishers, 49 W. 23 St., NEW YORK 10, N. Y.

Please send me postpaid for FREE EXAMINATION books marked (x) below. If I decide to keep them I agree to mail \$1 in 7 Days on each book ordered and further mail \$1 monthly on each book until I have paid price. Otherwise, I will return them.

- HANDBOOK OF ELECTRICITY, 1440 Pages \$4.
- AUTOMOBILE GUIDE, 1700 Pages . . . 4.
- REFRIGERATION & Air Conditioning, 1280 Pgs. . . 4.
- OIL BURNER GUIDE, 384 Pages . . . 1.
- POWER PLANT ENGINEERS Guide, 1500 Pages, . . . 4.
- PUMPS, Hydraulics & Air Compressors, 1658 Pgs., . . . 4.
- WELDERS GUIDE, 400 Pages . . . 1.
- BLUE PRINT READING, 416 Pages . . . 2.
- SHEET METAL WORKERS Handy Book, 388 Pgs. . . 1.
- SHEET METAL PATTERN LAYOUTS, 1100 Pgs. . . 4.
- AIRCRAFT WORKER, 240 Pages . . . 1.
- MATHEMATICS & CALCULATIONS, 700 Pgs. . . 2.
- MACHINISTS Handy Book, 1600 Pages . . . 4.
- MECHANICAL Dictionary, 968 Pages . . . 4.
- DIESEL ENGINE MANUAL, 400 Pages . . . 2.
- MARINE ENGINEERS Handy Book, 1280 Pages . . . 4.
- SHIPFITTERS Handy Book, 272 Pages . . . 1.
- MECHANICAL DRAWING COURSE, 160 Pages . . . 1.
- MECHANICAL DRAWING & DESIGN, 480 Pgs. . . 2.
- MILLWRIGHTS & Mechanics Guide, 1200 Pgs. . . 4.
- CARPENTERS & Builders Guides (4 vols.) . . . 6.
- PLUMBERS & Steamfitters Guides (4 vols.) . . . 6.
- MASONS & Builders Guides (4 vols.) . . . 6.
- MASTER PAINTER & DECORATOR, 320 Pgs. . . 2.
- GARDENERS & GROWERS GUIDES (4 vols.) . . . 6.
- ENGINEERS and Mechanics Guides . . . 12.
- Nos. 1, 2, 3, 4, 5, 6, 7 and 8 complete . . . 12.
- Answers on Practical ENGINEERING . . . 1.
- ENGINEERS & FIREMANS EXAMINATIONS' . . . 1.
- ELECTRICIANS EXAMINATIONS, 250 Pages . . . 1.
- WIRING DIAGRAMS, 210 Pages . . . 1.
- ELECTRICAL DICTIONARY, 9000 Terms . . . 2.
- ELECTRICAL POWER CALCULATIONS, 425 Pgs. . . 2.
- RADIOMAN'S GUIDE, 914 Pages . . . 4.
- ELECTRONIC DEVICES, 216 Pages . . . 2.
- ELECTRIC LIBRARY, 12 vol., 7000 Pgs., \$1.50 vol.

Name \_\_\_\_\_

Address \_\_\_\_\_

Occupation \_\_\_\_\_

Employed by \_\_\_\_\_ RN

R4340 will be furnished by the *Electronics Division, Sylvania Electric Products Inc., 500 Fifth Avenue, New York 18, New York.*

**VARIO-TUNER**

*Electronic Laboratories, Inc.* is currently offering their new E-L Vario-Tuner to the trade.

This permeability type radio tuner

may be used in table model receivers, eliminating the need for tuning condensers and coils while providing high gain operation.

This unit provides full band coverage from 540 to 1620 kc., a simplified circuit which is ready to be connected to the radio, no backlash and new ribbon drive, simple installation, and short-wave spread-band tuning.

**REDUCING NUMBER OF CAPACITORS OR RESISTORS IN DECADE BOXES**

TEN-POINT resistance or capacitance decade boxes often are built by laboratory workers. Radio servicemen and experimenters build less accurate versions of the same units and use them as resistor or capacitor substitution boxes. In both cases, it is customary to employ ten capacitors or resistors in each such box, in combination with a single-pole, 10-contact rotary selector switch.

By using the ideas illustrated by the accompanying schematics, the number of capacitors required in a decade box to obtain ten successive positions can be cut down to four, and the number of resistors cut down to five. Where precision capacitors or resistors are employed, this will afford a substantial saving of money and space. And in the case of substitution boxes, where accuracy requirements are less stringent, but components still must be hand-picked, the saving again is worthwhile. A 4-pole rotary switch does this unique job in the capacitor decade (Fig. 2) and a 2-pole switch is employed in the resistor decade (Fig. 1).

In the resistor decade, 1-, 3-, 5-, 2-, and 4-ohm resistors are connected in series in that order, as shown in Fig. 1A. The double-pole switch ( $S_1-S_2$ ) selects single units from 1 to 5 ohms (See Fig. 1B) and appropriate series

combinations of resistors from 6 to 10 ohms. This is a units decade. For a tens decade, use 10, 30, 50, 20, and 40-ohm resistors; for a hundreds decade, use 100-, 300-, 500-, 200-, and 400-ohm resistors; for a thousands decade, use 1000-, 3000-, 5000-, 2000-, and 4000-ohm resistors; etc.

In the capacitor decade, 10-, 20-, 30-, and 40- $\mu$ fd. capacitors are arranged as shown in Fig. 2A. The bottom pole ( $S_4$ ) of the 4-pole selector switch ( $S_1-S_2-S_3-S_4$ ) selects single units from 10 to 40  $\mu$ fd. and appropriate parallel combinations of capacitors (See Fig. 2B) from 50 to 100  $\mu$ fd. This is a tens decade. Home-made "units" capacitance decades are not very practicable because stray capacitances are apt to be of the same order of magnitude as the decade capacitances. For a hundreds decade, use 100-, 200-, 300-, and 400- $\mu$ fd. capacitors; for a thousands decade, use 1000-, 2000-, 3000-, and 4000- $\mu$ fd. capacitors; etc.

—30—

Fig. 1. Resistor decade.

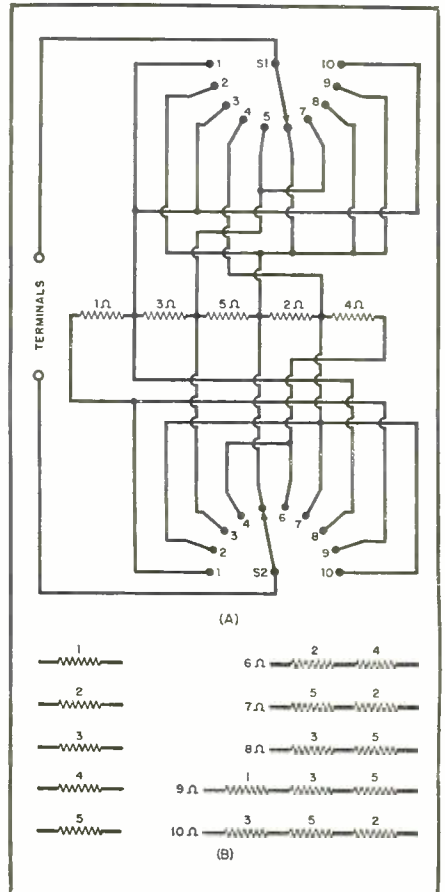
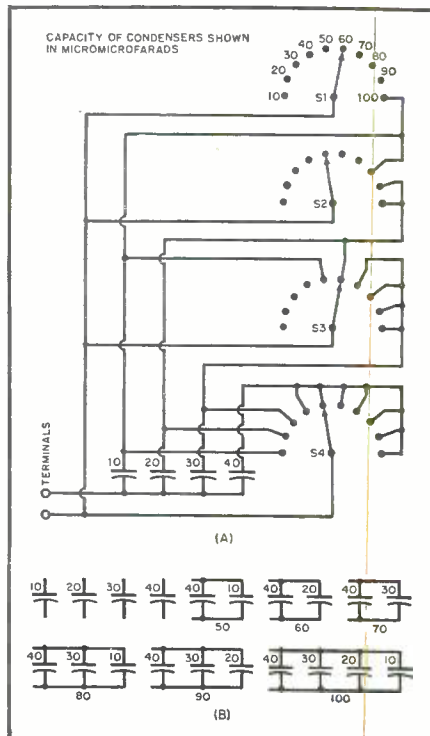
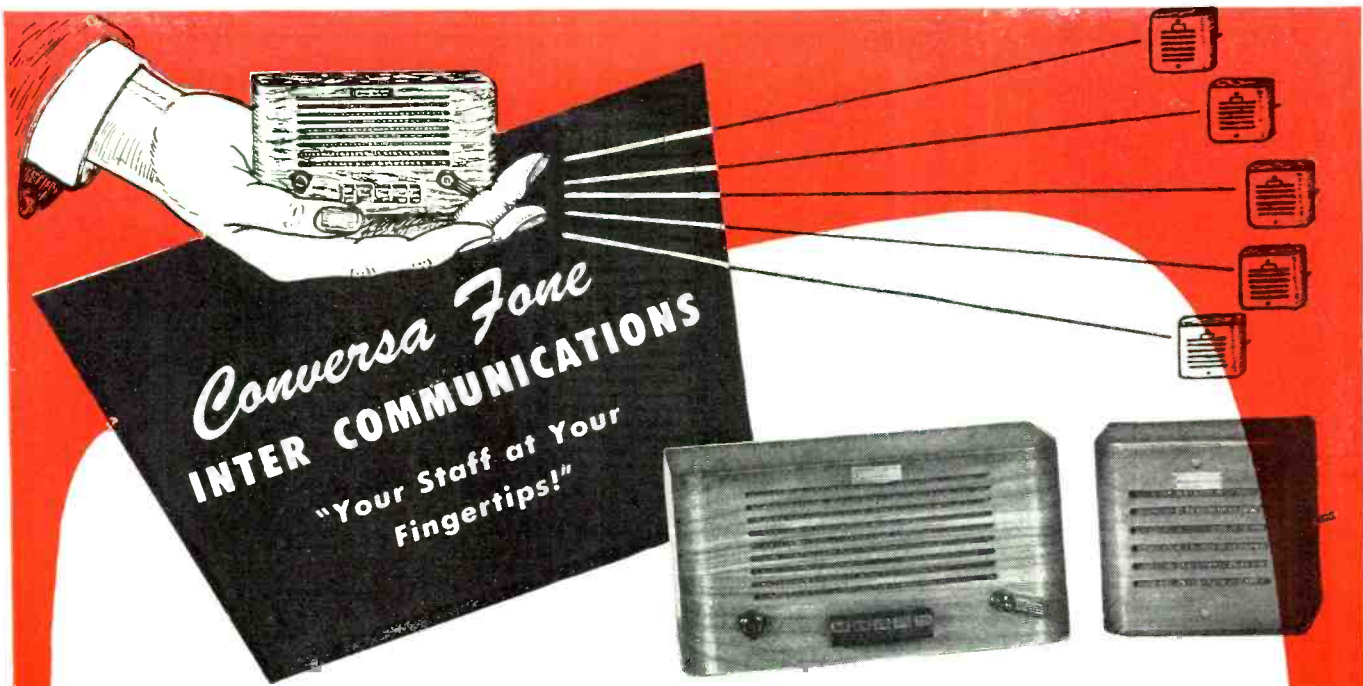

Fig. 2. Capacitor decade.







**Conversa Fone**  
**INTER COMMUNICATIONS**  
 "Your Staff at Your Fingertips!"

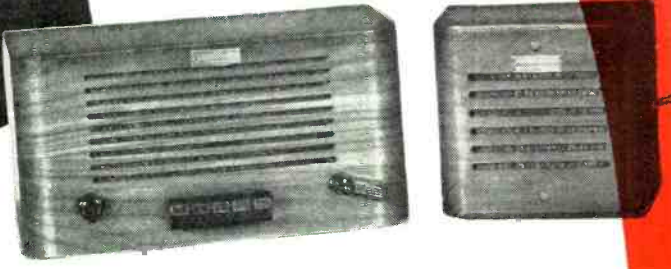

**MASTER STATION MODEL MS5**

- Luxurious, Handsome Cabinets Fashioned of Choice Walnut Woods
- Fingertip Volume Control
- Four-Piece Amplifier (no ballast tube)
- Four-Inch Alnico Speakers No. 5
- Designed for Home, Office, Factory
- Five Push Buttons for Instantly Selecting Sub Stations

Standard Equipment: One Sub Station and One Master Station. As requirements warrant, up to four more Sub Stations may be added. Master Station is silent during normal operation and Sub Stations can initiate calls to Master but cannot call or answer one another. Installation is exceedingly simple. Master and Sub packed in one carton. Additional sub-stations packed four to a carton.

**Additional Sub Stations.....EA. \$8.25      NET PRICE.....\$35.22**

Immediate Delivery

- FOR VERSATILITY • FOR PERFORMANCE
- FOR SIMPLE OPERATION AND INSTALLATION . . . IT'S CONVERSA FONE

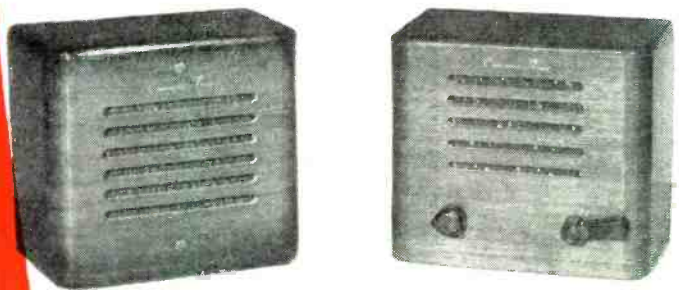

**COMBINATION KIT MODEL MS1**

- DeLuxe Walnut Cabinets
- 4" PM Alnico No. 5 Speaker
- Three-Tube, High-Gain Amplifiers (1—12SC7; 1—12A6; 1—35Z5)
- Excellent Tone Quality
- Volume Control
- Ideal for Two-Way Communication in Home, Office, or Factory

Standard Equipment: One Master Station and one Sub Station. Amazingly simple operation and installation. A low cost unit that can ideally fill any two way communication need. Packed one master and one sub to a carton.

**Net Price ..... \$25.46**  
 Immediate Delivery

**The Radio Shack Inc.**  
 630 W. RANDOLPH STREET CHICAGO 6, ILL.

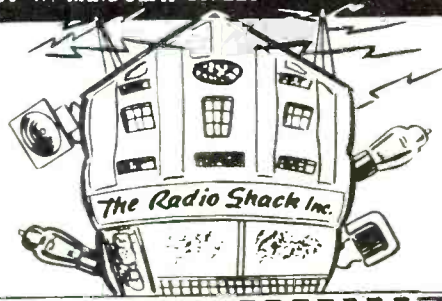

The Radio Shack Inc. of Chicago  
 630 West Randolph Street, Chicago 6, Illinois  
 ..... Please send literature on Conversa Fone Inter Office Communicators.  
 ..... Send Radio Shack's free illustrated catalog of thousands of radio and electronic parts values.  
 ..... Please ship—Model MS5—Model MS1—Additional Sub Stations.

Name .....

Address .....

City ..... Zone..... State.....

25% Deposit required on all C.O.D. orders

*Send coupon TODAY*



# MILO

Your "Q" for Quality

## FAMOUS NAMES

### HAMMARLUND

SP400-X Super Pro. This is the new model which covers a continuous range in 5 steps from .54 to 30 meg. Complete with Speaker. **\$347.25**

### HAMMARLUND HQ129-X

Frequencies cover .54 to 31 meg. in 6 steps. Complete with Speaker. **\$173.25**

### NATIONAL RECEIVERS

HRO 5TA. complete with Power Supply Speaker and Coils (1.7-4.0; 3.5-7.3; 7.0-14.4-14.0-30MC).

Additional coils available. . . . . **\$306.70**

NC 2-40D Complete with Speaker. . . **241.44**

NC 46 Complete with Speaker. . . . . **107.40**

### FEDERAL SELENIUM RECTIFIERS

6 to 49 **99¢** each

1 to 5 **\$1.09** each



Quotations on larger quantities gladly furnished

For Console Radios, AC-DC Portables, Vibrator Power Supplies, Intercom Power Supplies, replaces any 117 Volt Rect. Tube. Replace tube and socket; require less space; facilitate smaller cabinet design, prolong life of set, give immediate rectification. Schematic Application with each order

### TALK-A-PHONE

LP-110 Super Selective Systems

The LP-110 System is made up exclusively of Master Stations. With this system any station can call any other station in the system and in addition a number of two-way conversations can be carried on at one time. You can begin with 2 Masters and add up to a total of 10 in the LP-110 System. Each Master. **\$26.50**

Milo has complete stocks of Nationaly known IRC, Aerovox, B&W, Newcomb, Thordarson, Meissner, Tungsol, Weston, Supreme, National, SNC transformers, etc. If not rated, 20% with order, balance C.O.D. Dept. N.

# MILO

Radio and Electronics Corp.

200 Greenwich St., N. Y. 7, N. Y.

BEekman 3-2980-1

Cable Address "MILOELECTRO NEW YORK"

Suitable for inclusion in radio construction kits, for radio service dealers, amateurs, experimenters, engineers, radio schools and laboratories, the



tuner is packaged with complete details for the construction of a complete 6-tube radio receiver, together with a parts list.

Electronic Laboratories, Inc., Indianapolis 4, Indiana, will supply further details and prices on these units.

### TELEVISION KIT

Transvision, Inc. of New Rochelle, New York will soon begin distribution of a television kit, engineered for easy

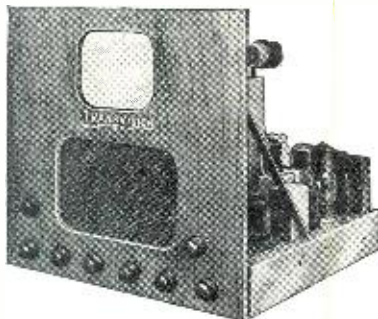

assembly by the layman as well as the technically trained.

The kit will contain, in addition to all the components, the necessary solder and wire and complete directions.

### REPLACING SHORT-WAVE SWITCH

IT IS important that wires to short-wave switches or coils be replaced in original position, after making repairs or cleaning switch.

Any new leads must be of the same length as the original. Such wiring should be dressed as found. See photo.



now you can

**SEE and HEAR** the signal

with the new **CA-12**

## Signal Tracer

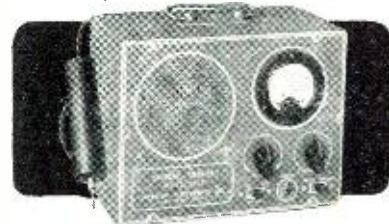

**Latest Superior Instrument product, featuring visible and audible signal detection...reducing the time to locate source of trouble to an absolute minimum.**

Simple to operate . . . only one connecting cable — no tuning controls.

Complete with Probe, Test Leads, self-contained Batteries and Instructions.

Immediate Shipment! **\$34.85**

### ARROW ELECTRONICS COMPANY

82 Cortlandt Street New York 7, N. Y. WHITEHALL 3-2696

### SUPER SPECIAL!

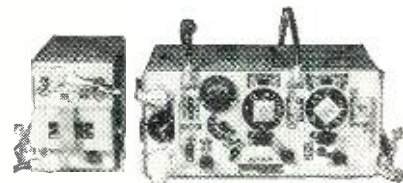

SG-3673 — Sender-Receiver assembly for telephone and telegraph includes:

No. 1 . . . 6 tube superher; 6 tube MOPA transmitter; 807 final P.A. Grid modulated for phone. Range 2 to 8 MC. including 40 and 80 meter amateur bands.

No. 2 . . . 235 MC transceiver. No modification necessary to operate on the new 1 1/4 meter amateur band.

Both units in one case as shown at A above. BRAND NEW — Less tubes . . . . . \$12.95

Power Supply Unit — (Dynamotor) — 550v-50ma and 275v-110ma — RF and AF Filter built in as shown at B. . . . . \$6.95

235mc half-wave antenna with matched coaxial lead-in . . . . . \$ .95

Antenna — 12 ft. with variometer loaded to resonate at 2 to 8 mc. — including heavy base mount . . . . . \$3.75

2" PM Speakers — bakelite cones in 2" black bakelite case with 3" flange. . . . . \$1.50

Dynamic hand mikes. . . . . \$2.50

Telegraph key and plug. . . . . \$ .75

Spare parts box and chassis. . . . . \$ .75

5 wire — 65 ft. cable with heavy duty weather-proof connectors. . . . . \$ .95

Control Unit Boxes. . . . . \$ .75

12 point cable and plug—50F \$25—50K \$50

### RADIO EQUIPMENT DISTRIBUTORS

312 W. Pico Blvd., Los Angeles 15, Cal.

RADIO NEWS



# They are THE WORLD'S OUTSTANDING RADIO and ELECTRONIC BOOKS

... all from a single source... with "instant service"

## RUSH SERVICE — Same-day shipment from Illinois or Calif.

Send orders only to Santa Barbara; those of \$10 or more for Eastern and Central points will be TELETYPE to Illinois warehouse for SAME-DAY shipment; smaller orders teletyped for 35c extra; others forwarded by AIR MAIL to warehouse. Complete stocks at Santa Barbara for Western orders.

### Radio Theory

#### FUNDAMENTALS OF RADIO, by F. E. Terman

A first book and also a good refresher for all radio students and workers. This text has been widely used in civilian and military classes. Requires no knowledge of complex mathematics.

Contents: The Fundamental Components of a Radio System, Circuit Elements, Resonant Circuits and Circuit Analysis, Fundamental Properties of Vacuum Tubes, Vacuum-tube Amplifiers, Power Amplifiers, Vacuum-tube Oscillators, Modulation, Vacuum-tube Detectors, Sources of Power for Operating Vacuum Tubes, Radio Transmitters, Radio Receivers, Propagation of Radio Waves—Antennas, Radio Aids to Navigation, Television, Acoustics.

Book No. TF10 458 pages \$4.00\*

#### PRINCIPLES OF RADIO, by Keith Henney

A basic course in radio which may readily be comprehended by high-school or trade-school students and may be used in independent home study. Well illustrated.

Contents: Fundamentals, Direct-Current Circuits, Electrical Meters and Measurements, Production of Current, Magnetism and Electromagnetism, Inductance, Capacitance, Properties of Alternating-Current Circuits, Resonance, Properties of Coils and Condensers, Vacuum Tubes, The Tube as an Amplifier, Rectifiers and Power Supply Apparatus, Audio Amplifiers, Detection, Receiver Systems, Oscillators, Transmitters, Antennas and Electromagnetic Radiation, Frequency Modulation, Ultra-High Frequency Phenomena, Electronic Instruments.

Book No. HP20 534 pages \$3.75\*

#### BASIC ELECTRICITY FOR COMMUNICATIONS, by W. H. Timbie

A student wishing a sound grounding in electrical fundamentals before undertaking the study of communications, and the communications student or worker requiring a reference book or refresher course in electricity will find Timbie admirably suited to the need. The few mathematical applications, which never go beyond simple algebra, are completely explained in this book. A summary follows each chapter, and well chosen problems are offered to test the student's learning and to give practice in applying electrical principles.

Book No. TB20 603 pages \$3.75\*

#### RADIO ENGINEERING, by F. E. Terman

Probably the most popular foundation engineering textbook for all serious radio courses and libraries. Thoroughly revised.

Contents: The Elements of a System of Radio Communication, Circuit Constants, Properties of Resonant Circuits, Fundamental Properties of Vacuum Tubes, Vacuum Tubes, Vacuum-tube Amplifiers, Power Amplifiers, Vacuum-tube Oscillators, Modulation, Vacuum-tube Detectors, Sources of Power for Operating Vacuum Tubes, Radio Transmitters, Radio Receivers, Propagation of Radio Waves, Antennas, Radio Aids to Navigation, Television, Sound and Sound Equipment.

Book No. TE10 813 pages \$6.00\*

#### by John Markus and Vincent Zeluff

This unique book condenses much invaluable electronic engineering data into graphs, charts, tables, and concise articles. In this way, it shortcuts the looking up of information. The tool value of this book is tremendous.

Book No. ME11 390 pages \$6.00\*

#### Leading Engineering Handbooks

##### RADIO ENGINEER'S HANDBOOK

by F. E. Terman

The wealth of technical data contained in this handbook makes it indispensable as a complete reference work on radio and electronics. Charts, tables, circuit diagrams, and concise text material simplify the solution of complex, as well as simple problems.

Tables, Mathematical Relations, and Units, Circuit Elements, Circuit Theory, Vacuum Tubes and Electronics, Vacuum-Tube Amplifiers, Oscillators, Modulation and Demodulation, Power Supply Systems, Radio Transmitters and Receivers, Propagation of Radio Waves, Antennas, Radio Aids to Navigation, Measurements.

Book No. TH10 1019 pages \$7.00\*

##### RADIO ENGINEERING HANDBOOK

by Keith Henney and Others

An extensive reference book prepared by 28 specialists. Contains abundant explanatory material, diagrams, formulas, and tables in each branch of the radio field.

Book No. HH10 945 pages \$6.00\*

### THE OUTSTANDING PRACTICAL HANDBOOK

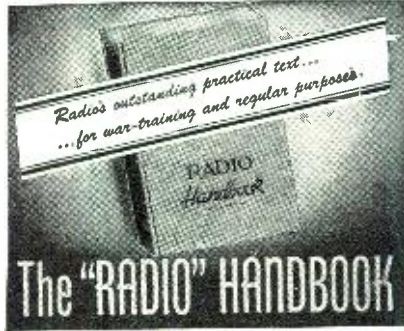

#### NEW, ENLARGED, TENTH EDITION

Radio's outstanding practical text. How-to-build-it descriptions of dozens of tested-and-tried types of transmitting, receiving and test equipment. Supplemented by basic electrical and radio theory in the simplest possible language for those without mathematical or technical training.

Illustrated with hundreds of diagrams and large photographs showing details of construction. Has the most complete tube tables to be found in any book.

New edition contains expanded U.H.F. sections, more test equipment which can be home-built, enlarged and modernized receiving and transmitting tubes tables, grounded-grid amplifier data, speech clipping, splatter suppressor, cathode follower data, pulse-time modulation, transformerless power supplies, wave guides, cavity resonators, butterfly circuit, klystron, U.H.F. crystal diode, radar, and highly-efficient mobile antennas.

The ideal text for the practical radioman. Over 700 pages, durably clothbound, gold-stamped. Book No. RH \$2.00 postpaid in continental U.S. \$2.25 elsewhere, postpaid.

#### PRACTICAL RADIO COMMUNICATION

by A. R. Nilson and J. L. Hornung

A complete radio manual covering subjects of interest particularly to the commercial radio operator. Topics include basic electricity; transmitters, receivers, and associated apparatus; and operating instructions. FM and ultra-high frequencies are included in this new edition. May be mastered by the average high school or trade school student.

Book No. NC10 927 pages \$6.50\*

#### HOW TO PASS RADIO LICENSE EXAMINATIONS

by C. E. Drew

A well illustrated and long-used question and answer manual for the coaching of candidates for the commercial radiotelegraph and radiotelephone operator license examinations. New post-war edition.

Book No. DH20 320 pages \$3.25\*

#### U.H.F., F.M., and Television

U.H.F. RADIO SIMPLIFIED, by Milton S. Kiver

U.h.f. radio simply and clearly explained, in plain English, without mathematics. Covers principles, applications, and equipment; adapted for home study.

Book No. KU30 242 pages \$3.25\*

#### INTRODUCTION TO MICROWAVES

by Simon Ramo

This book is unique in that it is a simple introduction to microwaves written in clear English and avoiding the use of mathematics altogether.

Book No. 138 pages \$2.00\*

#### TELEVISION SIMPLIFIED, by Milton S. Kiver

A simplified explanation of modernized television, especially as it pertains to the operation and maintenance of television receivers. A "simple language" text readily understood by those with fair radio knowledge.

Book No. KT30 432 pages \$4.75\*

### We Also Regularly Stock These Books

Send stamp for complete catalog

Elementary Theory	
"Fundamentals of Radio," Terman	\$4.00*
"Principles of Radio," Henney	3.75*
"Basic Elec. for Commun.," Timble	3.75*
"Elements of Radio," Marcus	4.00*
"Fundamentals of Radio," Everett	5.00*
"Understanding Radio," Watson	2.80*
"Electrical Commun.," Albert	5.00*
"Electrical Fundamentals," Alberikus	4.00*
"Basic Radio," Hoag	3.50*
"Short Wave Wireless Commun.,"	6.50*
"Radio Fundamentals," Prin. & Lath	1.50*
"Basic Radio Principles," Suffern	3.50*
"Radio Physics Course," Ghirardi,	5.00*
"Electrical Essentials of Radio,"	4.50*
and Osterheld	4.50*
Intermediate and Advanced Theory and Engineering	
"Radio Engineering," Terman	\$6.00*
"Fund. of Engng. Electronics,"	5.50*
"Prin. of Radio Commun.," Morescroft	8.00*
"Engineering Electronics," Fink	4.00*
"Applied Electronics," W.L.T. Lath	3.80*
"Communication Engineering,"	5.50*
"Electronics," Millman and Seely	5.50*
"Electronics for Engineers,"	6.00*
"Fund. of Electric Waves," Skilling	3.00*
"High-Frequency A.C.," McIlwain	6.50*
"Radio Receiver Design,"	5.00*
"Technique of Radio Design," Zepfer	4.00*
"Prin. of Radio Engineering,"	4.50*
"Communication Networks,"	5.50*
Vol. 2	8.00*
"Electrical Engineer's Handbook,"	6.00*
"Radio Designer's Handbook,"	1.00*
Electron Tubes and Industrial Electronics	
"Electron Tubes in Industry," Henny	\$5.50*
"Industrial Electronic Control,"	2.75*
"Electronics in Industry," Chute	3.80*
"Theory and Appl. of Electron Tubes,"	5.50*
"Principles of Electron Tubes,"	4.00*
"Guide to Vacuum Tube Data,"	4.50*
"Fund. of Vacuum Tubes," Eastman	5.00*
"Prin. of Electronics," Kioeffler	2.75*
"Physics of Electron Tubes," Koller	3.25*
"High Freq. Thermionic Tubes,"	3.50*
"Theory of Thermionic Vacuum Tubes,"	6.50*
"Fundamental Electronical	4.65*
"Electromagnetic Waves,"	7.50*
"Electromagnetic Theory,"	6.50*
"Circuit Circuits," M.I.T.	3.50*
"Photocells and Their Applications,"	3.50*
"Graph. Constr. for Vacuum Tube Cir.,"	3.00*
"Elect. Optics and Electronics,"	10.00*
"Gaseous Conduction and Electronics,"	5.00*
"Electronic Control," Chute	4.50*
Radio Mathematics	
"Math. for Elec. & Radiomen,"	\$4.50*
"Appl. Math. for Radio Engrs.,"	3.50*
"Mathematics of Radio Commun.,"	3.30*
Ultra-High Frequencies	
"U.H.F. Radio Simplified," Kiver	\$3.25*
"Introduction to Microwaves,"	2.00*
"Microwave Transmission,"	4.00*
"Communication Circuits," Ware	3.75*
"Hyper and U.H.F. Engr.,"	6.00*
"Fields and Waves," Ramo	5.50*
"Transmission Lines, Antennas,	3.50*
"Electromagnetic Engr.," King	6.00*
"Phenomena in U.H.F. Systems,"	6.50*
Commercial Operating Practice	
"Practical Radio Communication,"	\$6.50*
"Radio Direction Finders,"	3.50*
"Prin. Aero. Radio Engr.,"	4.00*
"Aircraft Radio and Elec. Equip.,"	4.50*
"Aeronautic Radio," Eddy	4.50*
"Radio Navigation for Pilots,"	2.75*
"The Radio Manual," Sterling	6.50*
"Radio Code Manual," Nilson	2.75*
Radio Servicing	
"Modern Radio Servicing," Ghirardi	\$5.00*
"Prin. and Prac. of Radio Servicing,"	4.00*
"Radio Service Trade Kinks,"	3.50*
"Radio Troubleshooter's Handbook,"	5.00*
"Cathode Ray Patterns," Bly	1.75*
Books by John F. Rider	
"Auto. Record Changers and Recorders,"	\$9.00*
"Vacuum Tube Voltmeters,"	2.50*
"Servicing by Signal Tracing,"	4.00*
"Frequency Modulation,"	2.00*
"The Meter at Work,"	2.00*
"The Oscillator at Work,"	2.50*
"The Cathode Ray Tube at Work,"	4.00*
"Servicing Superheterodynes,"	2.00*
"Automatic Freq. Control Systems,"	1.75*
"Servicing Receivers by Resis. Meas.,"	2.00*
"D.C. Voltage Dist. in Radio Receivers,"	1.25*
"Alternating Currents in Radio Receivers,"	1.25*
"Resonance and Alignment,"	1.25*
"Automatic Volume Control,"	1.25*
F.M. and Television	
"Television Standards and Prac.,"	\$5.50*
"Frequency Modulation,"	4.50*
"Electron Optics in Television,"	4.00*
"Television Simplified," Kiver	4.75*
"High Frequency Television,"	5.00*
"Television," Zworykin and Morton	7.00*
"Principles of Television Engineering,"	5.50*

\*Add 3% (minimum, 10c) for postage and packing; foreign, 10%. In Ill. and Calif. add sales tax. Prices are in U. S. dollars and are subject to change without notice.

**HOW TO ORDER:** TO AVOID ERRORS give book number, author's surname, and title. REMIT by draft, money order, or check; currency, etc. is at your risk; foreign remittances must be in U. S. dollars. FASTER SERVICE when full remittance accompanies order; C.O.D.s accepted but take longer to handle, and cost an extra fee.

Editors and Engineers 1302 KENWOOD ROAD Santa Barbara CALIFORNIA



**For CONTINUOUS  
HEAVY DUTY  
SERVICE . . .**



**Flash** MODEL HF-150  
**SOLDERING GUN**

5/8" Tip with extra heavy replaceable carbon heating element



**INDUSTRIAL MODEL TRANSFORMER**

For heavy continuous use or multiple unit operation with either Model SF-100 or HF-150.

There is no soldering job too tough for the Flash Model HF-150 —with its 5/8" heavy duty tip. It's a rugged performer, but light weight and balanced just right with cool, non-tiring pistol grip. You control heat with trigger finger—heats instantly. Works from 6-12 V battery or 110 V transformer shown at left.

**ALSO STANDARD MODEL SF-100 HEATS IN 6 SECONDS.**—It's "quick on the trigger"—gets the work done fast. Wonderful to get around corners and into tight places. Heats while you press trigger. Interchangeable tips. Works from 6-12 V battery or 110V transformer. Try a Flash. You'll like it!

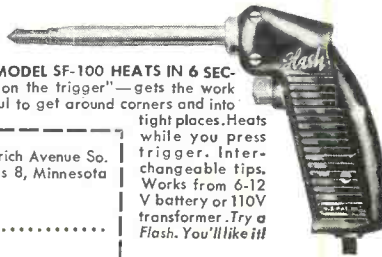

**BAKER-PHILLIPS COMPANY** 2816-1 Aldrich Avenue So. Minneapolis 8, Minnesota

Please send circular on Flash Soldering Guns.

Name .....  
Address .....

**GET YOUR  
FCC Commercial Radio Operators' LICENSE**

*Now...*

**How To Pass  
FCC  
LICENSE  
EXAMINATIONS**  
CLEVELAND INSTITUTE  
OF  
RADIO ELECTRONICS  
Terminal Tower - Cleveland, Ohio

**IT'S EASY IF YOU FOLLOW OUR PLAN!** Thousands of new jobs are opening up—FM, TELEVISION, MOBILE COMMUNICATION SYSTEMS, are only a few of the new radio fields which require licensed operators.

**FREE BOOKLET** Tells you the Government Requirements for all classes of commercial licenses. Saves you many hours of random, undirected study. Assures a minimum of time in getting your ticket! Approved for Veteran Training Under G-I Bill of Rights

**CLEVELAND INSTITUTE OF RADIO ELECTRONICS**  
Successors to Nilson Radio School, founded 1939  
Smith Practical Radio Institute, founded 1934  
RN-1 TERMINAL TOWER CLEVELAND 13, OHIO

**Don't Delay—  
Write Today!**

MAIL THIS COUPON  
CLEVELAND INSTITUTE OF RADIO ELECTRONICS  
RN-1 Terminal Tower, Cleveland 13, Ohio  
Gentlemen: Please send your FREE Booklet, "How to Pass FCC License Examinations."  
(NOTE: This booklet does not cover examinations for Amateur Licenses.)  
Name \_\_\_\_\_  
Address \_\_\_\_\_  
City \_\_\_\_\_ Zone \_\_\_\_\_ State \_\_\_\_\_  
 If a Veteran check here

The picture tube included in the kit is a seven inch electrostatic type, giving a large enough picture to be viewed by 8 to 15 people. The receiver incorporates 18 tubes, 3 i.f. picture stages, 3.5 megacycle bandwidth in the picture circuit, a newly designed sweep circuit, and 3000 volts second anode supply which provides sufficient brilliance to allow daylight viewing.

Further information on these kits may be secured by writing the manufacturer, *Transvision, Inc.*, 144 Union Avenue, New Rochelle, New York.

**SPECIAL TRAINING FILMS**

Because of the rapid increase in turnover among sales personnel, the problem of training suitable sales help is a real one for the radio and appliance retailer.

In order to cut down training time,



the *Jam Handy* organization has recently completed a series of five training films, the purpose of which is to help train sales personnel in proper floor conduct and customer contact in the postwar era.

Each of these films is accompanied by a disc record carrying commentary and voices. An instructor's manual accompanies the films and records, providing a pattern of procedure in holding visualized meetings. Subjects covered in this series include: friendliness, attentiveness, helpfulness, sincerity, and enthusiasm.

**ECA TABLE MODEL**

*Electronic Corporation of America* has recently announced that their Model 201 table receiver will be released from production shortly.

This new model, which employs



miniature tubes, is a 5 tube receiver housed in a two-tone, wrap-around wood cabinet.

The Model 201 also features a new type of circuit which reduces hum output, and an improved i.f. amplifying

**RADIO NEWS**



# RHS TELEVISION-SCOPE-POWER EQUIP'T

## POWER SUPPLY FOR MARK 1-11-111 BC-19 OR OTHER EQUIPMENT

12 Amp-12v D.C. from 110v A.C. Unnecessary to tear set apart. Leave set portable. COMPLETE READY TO PLUG IN **\$32.50**

## OIL CONDENSERS

1 mfd. 600v....\$0.35	1 mfd. 2000v....\$0.95
2 mfd. 600v.... .60	2 mfd. 2000v.... 2.10
4 mfd. 600v.... .75	3 mfd. 2000v.... 2.95
8 mfd. 600v.... 1.10	4 mfd. 2000v.... 3.95
10 mfd. 600v.... 1.40	10 mfd. 2000v.... 4.35
1 mfd. 1000v.... .90	.05 mfd. 3000v.... 1.95
2 mfd. 1000v.... 1.05	.25 mfd. 3000v.... 2.95
4 mfd. 1000v.... 1.10	1 mfd. 3000v.... 3.50
8 mfd. 1000v.... 2.00	2 mfd. 3000v.... 6.75
10 mfd. 1000v.... 2.40	1 mfd. 4000v.... 3.85
15 mfd. 1000v.... 2.60	2 mfd. 4000v.... 7.60
6 mfd. 1500v.... 2.56	1 mfd. 7000v.... 3.95
24 mfd. 1500v.... 6.95	1 mfd. 9000v.... 14.95

## MICA CONDENSERS, SANGAMO

.001-2000v....\$5.95	.004-8000v....\$2.25
.0005-2000v.... 4.95	.002-8000v.... 2.25
.0005-8000v.... 2.25	.006-6000v.... 1.95
.0025-8000v.... 2.25	.007-5000v.... 1.75
.005-8000v.... 2.25	.003-8000v.... 2.25

G.E. Vacuum Capacitor  
50 MMF. 7500v **\$3.95**

## HIGH CAPACITY CONDENSERS

2100 mfd.—50VVDC.....\$1.95
4000 mfd.—18VVDC..... 1.95
4000 mfd.—50VVDC..... 2.95
1000 mfd.—15VVDC..... .99

## METERS—G.E., WESTON, etc.

<b>3/2 ROUND</b>	
0-1.5 ma. ....\$4.95	0-8 amps. R.F. \$4.95
0-5 ma. .... 4.95	0-15 amps. R.F. 5.50
0-50 ma. .... 4.95	0-3.5KV W/ shunt ..... 5.50
0-100 ma. .... 4.95	0-15v A.C. .... 4.50
0-500 ma. .... 4.95	0-150v A.C. .... 4.50
0-115 ma. R.F. 4.95	0-350v D.C. .... 3.95
150-0-150 Micro amps. .... 5.95	Frahm Freq. Meter 58-62 cyc. .... 4.95
<b>2/2 ROUND</b>	
0-150v A.C. ....\$3.95	Decibel —10+20 .... 3.95
0-20v D.C. .... 3.25	0-1 ma. .... 3.50
0-10v D.C. .... 2.85	0-8 amps. .... 2.95

## PORTABLE TRANSMITTER & RECEIVER NAVY TBV

28-80mc (5 and 10 meter bands). Complete with phones, mike, 8 tubes, crystal and key. Slightly used, fine condition. **\$42.50**  
Wonderful buy  
Vibrator and storage battery **\$19.95**  
power supply for above.....

## NATIONAL DRIVE UNIT ONLY

PW-O or  
NPW-O **\$2.95**

## TUBES (Brand New)

### ARMY-NAVY INSPECTED

6C4 .....\$0.75	954 .....\$0.99
6I6 ..... .99	955 ..... .99
6P6 ..... .99	956 ..... .99
6L6 ..... 1.25	957 ..... .99
6V6 ..... .99	958 ..... 1.10
6C5 ..... .90	959 ..... 1.15
6J5 ..... .90	9002 ..... .89
6AL5 ..... .99	9003 ..... .89
6AC7 ..... .95	9001 ..... .99
6AB7 ..... 1.25	9005 ..... 1.10
6AG7 ..... 1.25	9006 ..... 1.15
6AK5 ..... 1.60	1625 ..... .89
6SN7 ..... .99	1626 ..... .89
6SL7 ..... .99	1629 ..... .89
VR-90 ..... .99	30 ..... .89
VR-105 ..... .99	1E7G ..... 1.25
VR-150 ..... .99	881 ..... 1.50
811 ..... 3.25	2050 ..... 1.50
866 ..... 1.19	2051 ..... 1.50
813 ..... 9.95	257B/ 8001 ..... 14.95
807 ..... 1.35	VT. 127A 3.50
15E ..... 4.95	726A/C. 7.50
2AP1 ..... 4.95	6SH7 ..... .89
3BP1 ..... 5.95	7A4 ..... 1.45
5BP1 ..... 7.95	2C10 ..... 9.95
5BP4 ..... 8.95	836 ..... 3.50
91P1 ..... 14.95	872A ..... 3.50

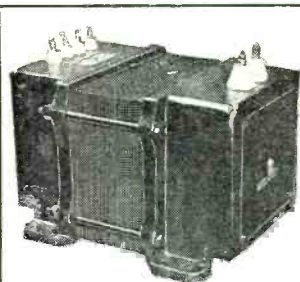

## AMERTRAN HEAVY DUTY PLATE TRANSFORMER

For your dream rig. Pri. 105-115v, 60 cycle. Sec. 3100-0-3100, full voltage across sec. 6200v at 700Ma. Rated 2KVA. **\$39.95**  
Our Price

## AMERTRAN FILTER CHOKE

3kV Test—32ohm D.C. **\$5.95**  
Res. 4 Hy. 600 ma. ....

## MODULATION XFORMERS

400 Watt Audio (Westinghouse) Separate Plate and Screen Winding Z Ratio—3 to 1 Pri. to Sec. Can use 803's, 100TH's, 813's, HK254's, etc. **\$24.95**  
Special

300 Watt—Class 'C' load on pri. #1 4000 ohms-pri. #2 desig. for screen of Tetrode or Pentode-Pri. will match 811, 809, T220 and T240 tubes. **\$4.95**

Driver Transformer for the above: single 4V6 to Push **\$3.95**  
Pull 811's

Thordarson 10 Watt **\$1.95**  
#T-17M59

## OSCILLOSCOPE KIT

5CP1 Cathode Ray Tube. Each.....	\$6.95
Socket for 5CP1. Each.....	1.98
Anode Burton for 5CP1. Each.....	.35
Shield for 5CP1. Each.....	1.49
2X2A Rectifier Tube. Each.....	1.25
Plate Cap for 2X2A Ceramic. Each.....	.20
Socket for 2X2A Ceramic. Each.....	.25
Xformer, 1600v, 6.3v, 2.5v, 110v. 60cyc. Each...	7.50
Condenser. Oil. 5-2000v. Each.....	2.10
Order separately or COMPLETE KIT. Special.....	<b>\$16.95</b>

## XFORMERS, SCOPE & TELEVISION

### 115v.-60 cyc.

6500v at 4 ma. ....	\$ 9.95
6000v at 2 ma. ....	7.95
3950v at 4 ma., tap at 1250v-1 ma. ....	7.50
3710v-10 ma.; 2.5v at 3A; 2.5v at 3A.....	9.95
2500v-10 ma. ....	6.50
4000v-2 ma. ....	6.50
2050v-2 ma.; 2.5v at 3A.....	8.95
442-0-442v at 1000 Ma. ....	19.95

## XFORMERS, FILAMENT

### 115v.-60 c.

2.5v at 1.75a; 6.3 at 1 amp, H.V. Ins.....	\$ 3.95
2.5v at 10 amps.....	3.25
2.5v at 2a, 6.3v at 1 amp. Hi Volt. Ins.....	3.95
6.3v at 21.5a, 2v at 2a, 4v at 1a.....	6.95
5.0v at 115a.....	14.95
5.0v at 190a.....	17.50
2.5v at 3a, 6500v Ins.....	3.95

## FILTER CHOKES

### Hi-Voltage Insulation

1 Hy.—200 ma. ....\$2.25	12 Hy.—300 ma. ....\$3.95
4 Hy.—250 ma. .... 3.95	15 Hy.— 30 ma. .... 1.95
10 Hy.—250 ma. .... 3.25	20 Hy.— 30 ma. .... 2.25
12 Hy.—150 ma. .... 2.95	75 Hy.— 8 ma. .... 1.95

## RELAYS

Sigma #4RJ 2000 ohms SPDT. Can adjust **\$1.98**  
to less than 1 ma. ....  
6v D.C. coil DPDT norm. clos. ....**\$0.98**  
6v D.C. coil SPST norm. open..... .98

## TRANSMITTER SHELF T66CRN-10

Complete RF section uses 1 807 Crystal oscillator tripler, 1 807-RF doubler, 1 257B-RF tripler driving 2 257B's RF amplifier in push pull, 1 6H6-RF output indicator. All volts and current read on 2 Weston meters through panel switch. Now on 110mc. Slight change to 144mc. Capable 500 watts out. **\$39.95**  
put. Less tubes and crystal. Reduced to...

All material is new and guaranteed unless otherwise stated

No mail orders for less than \$2.50. 20% deposit required with all orders.

# RADIO HAM SHACK Inc.

63 DEY STREET, NEW YORK 7, N. Y.





**ALLIED**  
*Sound for '47!*  
**New 30 WATT DeLuxe**  
**PORTABLE P. A. SYSTEM**

Here's a preview of ALLIED Sound for 1947 in this smoothly-styled, brilliantly engineered 30 Watt De Luxe Portable System. New stabilized inverse feedback circuit delivers high output, usable right up to its peak. Flexible operation is provided by two microphone and one phono channels, each with separate control. Has bass-treble tone control. Amplifier and speakers are safety-fused. Amplifier gain on microphone is 128 db; on phono, 80 db. Frequency response: 50-10,000 CPS. System covers up to 4,000 persons, or up to 20,000 square feet.

**Complete 30 Watt System includes:** 30-Watt De Luxe Amplifier with tubes; 2-12" Safused Dynamic Speakers, with 30-ft. cables and plugs; 1-Cardax Unidirectional Microphone with floor stand and 20-ft. cord and plug. Complete in handsome luggage-type split portable carrying case, 22"x20"x15". Carrying wt., 60 lbs. For 110 volts, 60 cycles A.C. (Less phono top and volume level meter which are optional.)

Complete System (approximate price) Only ..... **\$99.50**

**ALLIED**  
**For Everything**  
**in Radio and**  
**Sound**

See your ALLIED Catalog No. 111 for the world's largest and most complete stocks of quality radio and sound equipment—at today's lowest prices! Count on ALLIED for fast service, expert help. If you haven't a copy of Catalog No. 111—send for it now—it's FREE for the asking.

**ALLIED RADIO**  
**ALLIED RADIO CORP.**  
 833 W. Jackson Blvd., Dept., 1-A-7, Chicago 7, Ill.  
 Ship 30-Watt Portable System described above. S..... enclosed.  
 Send full details on ALLIED Sound.  
 Send FREE Radio Catalog No. 111.  
 Name.....  
 Address.....  
 City..... Zone..... State.....

system which provides increased selectivity and high sensitivity, according to the manufacturer.

A full vision slide-rule illuminated dial with bombsight indicator and convex dial shield contribute to the modern appearance of the radio.

*Electronic Corporation of America*, 170 53 St., Brooklyn 32, New York will furnish additional details upon request.

**NEW DIA-CONE SPEAKER**

*Altec Lansing Corporation* has recently announced the addition of the Model 600 Dia-Cone speaker to their line.

Designed as a production unit for home radio, phonograph, music system and FM reception, this speaker uses the exclusive Dia-Cone principle of reproducing low frequencies and high frequencies on separate diaphragms.

The Model 600 speaker is mounted in a 12" frame and uses an Alnico V permanent magnet and a 3" wound aluminum voice coil to which is mounted a domed aluminum alloy



metal diaphragm and a seamless molded cone. The seamless molded cone vibrates as a piston with the voice coil to reproduce all lower frequencies up to approximately 2000 cycles.

Although normally supplied without a cabinet, various types and sizes of cabinets are available for mounting this speaker.

Inquiries regarding this model should be addressed to *Altec Lansing Corporation*, 250 West 57th Street, New York 19, New York.

**NEW TIMING MOTOR**

Just announced by the *A. W. Haydon Company* of Waterbury, Connecticut, is their new Circle B, timing motor which incorporates several new features.

Exceptionally compact, the Circle B Timing Motor easily fits in a 2" circle.

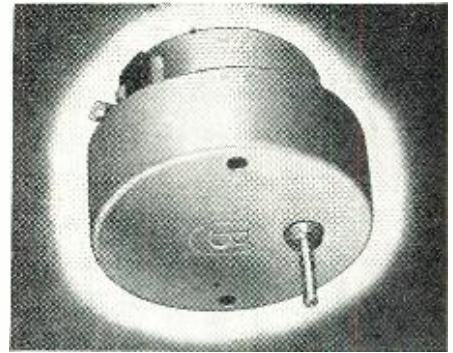

Among the other features of this motor are: through holes for mounting, easy-to-solder terminals, no straggly lead wires, no ears sticking out, etc.

Production of this motor is limited, at the present, to 1 and 5 r.p.m. speeds, with other speeds available. Voltage ratings are 110, 220 and 24 volts at 60 cycles.

Complete information and prices will be furnished by writing direct to *A. W. Haydon Company*, Department P, Waterbury, Connecticut.

**MINIATURE SELENIUM RECTIFIER**

The Seletron Division of *Radio Receptor Company, Inc.* is currently in production on a new miniature five

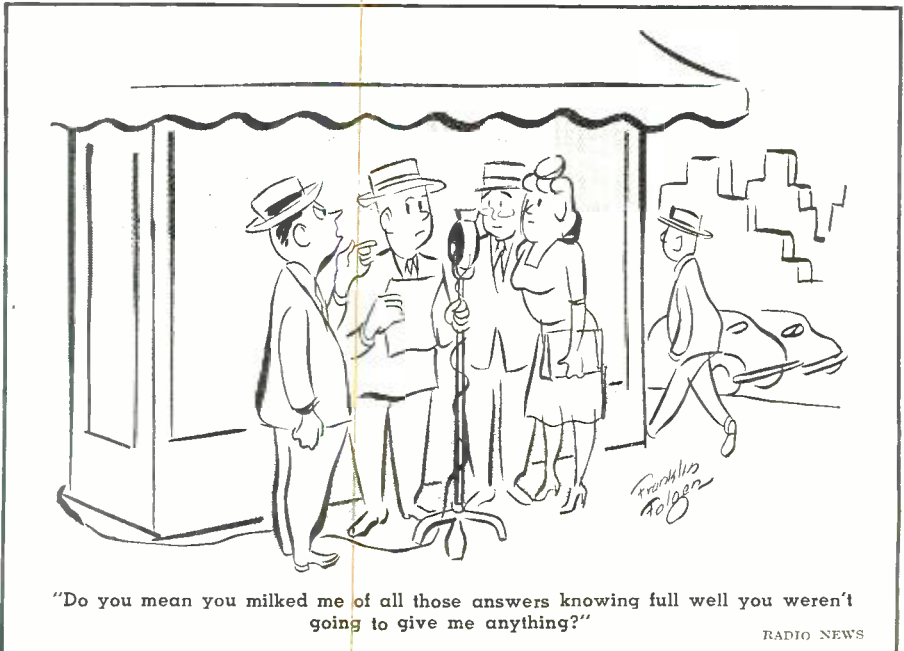



# New!

## Series 200

# A RELAY BY GUARDIAN with Interchangeable Coils

### BUILT IN TWO PARTS

A.C. Coil Assemblies available for 6 v., 12 v., 24 v., 115 v.  
D.C. Coil Assemblies available for 6 v., 12 v., 24 v., 32 v., 110 v.

★ Two basic parts—a coil assembly and a contact assembly—comprise this simple, yet versatile relay. The coil assembly consists of the coil and field piece. The contact assembly consists of switch blades, armature, return spring, and mounting bracket. The coil and contact assembly are easily aligned by two locator pins on the back end of the contact assembly which fit into two holes on the coil assembly. They are then rigidly held together with the two screws and lock washers. Assembly takes only a few seconds and requires no adjustment on factory built units.

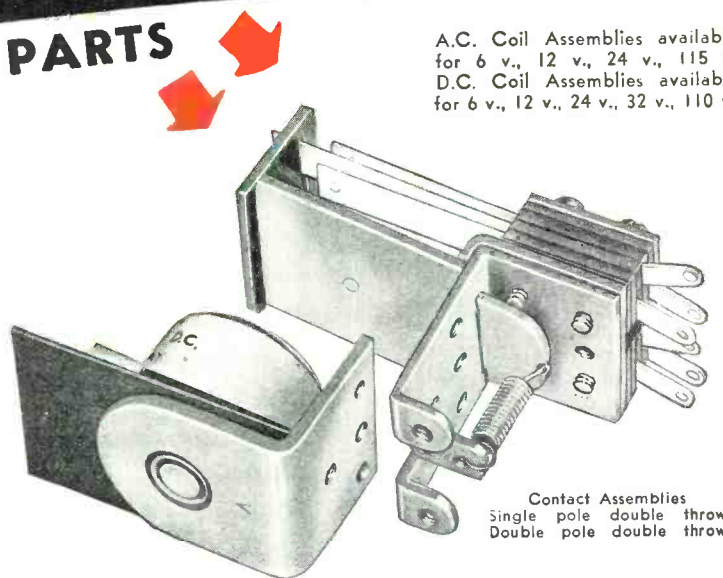

SERIES 200 RELAY

Contact Assemblies  
Single pole double throw  
Double pole double throw

## On Sale at Your Nearest Jobber NOW!

See it today! . . . this amazing new relay with interchangeable coils. See how you can operate it on any of nine different a-c or d-c voltages—simply by changing the coil. Ideal for experimenters, inventors, engineers.

### TWO CONTACT ASSEMBLIES

The Series 200 is available with a single pole double throw, or a double pole double throw contact assembly. In addition, a set of Series 200 Contact Switch Parts, which you can buy separately, enables you to build dozens of other combinations. Instructions in each box.

### NINE COIL ASSEMBLIES

Four a-c coils and five d-c coils are available. Interchangeability of coils enables you to operate the Series 200 relay on one voltage or current and change it over to operate on another type simply by changing coils.

Your jobber has this sensational new relay on sale now. Ask him about it. Or write for descriptive bulletin.



# GUARDIAN ELECTRIC

1630-A W. WALNUT STREET

CHICAGO 12, ILLINOIS

A COMPLETE LINE OF RELAYS SERVING AMERICAN INDUSTRY



# NEW YEAR SMASH HITS!

▶ Don't forget that we regularly carry all popular and nationally known lines in parts, tubes and equipment . . . as well as the SMASH SPECIALS advertised here!

## KENYON 115 VOLT AC

60 cycle transformer cased job with insulators.

2500 V Sec. @ 2 mils.  
6.3 V Sec. @ .6 Amp.  
2.5 V Sec. @ 1.75 Amp.

**\$375** ea.

## SIGNAL CORPS V9

4 Prong Standard Vibrator. Lots of 5 . . . . . \$1.50 ea.

4 mfd—600 V G.E. Oil Cond. . . . . 95c ea.  
8 mfd—600 V G.E. Oil Cond. . . . . \$1.25 ea.

## POPULAR 5" PM SPEAKER

Alnico 5 2.5 oz. slug—Big Value!  
Lots of 5 . . . . . \$1.66 ea.

## TUBULAR ELECTROLYTIC

With leads and bracket 40—30—20 mfd.  
All at 150 volts. Lots of 10 65c. ea.

## OPEN-TYPE FILAMENT TRANSFORMER

Pri—115V—60 cycle  
Sec. #1—6.3 V—16.0 Amp.  
Sec. #2—6.3 V— .9 Amp.  
Sec. #3—2.5 V— 3.0 Amp.  
Sec. #4—2.5 V— 3.0 Amp. **\$275** ea.

U.T.C. No. VM3—125 Watt Mod. Transformer . . . . . \$18.00

U.T.C. No. VM4—300 Watt Mod. Transformer . . . . . 30.00

U.T.C. No. VM5—600 Watt Mod. Transformer . . . . . 69.00

## TEST EQUIPMENT

RCA VOLTOHMYST . . . . .	\$ 69.50
RCA CHANALYST . . . . .	162.50
RCA TEST OSCILLATOR . . . . .	63.75
WESTON #697 VOLTOHMMETER . . . . .	26.52
WESTON #779 ANALYZER . . . . .	76.46
WESTON #785 CIR. TESTER . . . . .	87.02
WESTON #798 MUTUAL CONDUCTANCE TUBE CHECKER . . . . .	187.09
HICKOK #125 VT V.O.M. . . . .	94.95
HICKOK #191X MICROVOLT GENERATOR . . . . .	145.92
HICKOK #203 ELECTRONIC VTVM . . . . .	79.80
HICKOK #288X SIGNAL GENERATOR . . . . .	144.60
HICKOK #534 TUBE & SET TESTER . . . . .	138.30

25% deposit, balance C.O.D. Please include sufficient payment for transportation. Overpayment will be refunded.

**Standard Parts Corp.**

235 Main Street, Dept. RN, Hempstead, N. Y.

plate selenium rectifier, the 5M1, which has been designed to replace such rec-

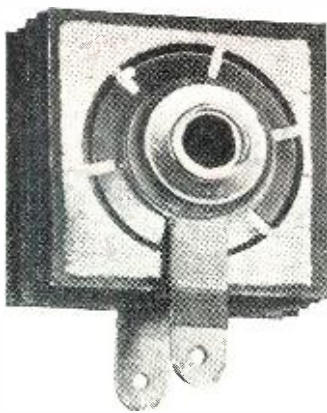

tifier tubes as 26Z5, 35Z5, 117Z6, 0Y4, and others in a.c.-d.c. battery portables, consoles and vibrator power supplies.

This unit, 1" x 1" in size, features high current capacity and low loss.

The 5M1 is designed to be used with 25 ohm series resistor and maximum capacitance of 40  $\mu$ fd. Maximum continuous current is 100 ma. at an ambient temperature of 35 degrees C. The d.c. output voltage and maximum a.c. input voltage is 130 volts.

Radio Receptor Company, Inc., 251 West 19th Street, New York 11, New York, will furnish additional data on request.

## FM CONVERTER

Waterproof Electric Company of Burbank, California is currently in production on a small unit for converting FM receivers operating on the 42-50 mc. band to the new FM broadcast band.

This unit requires no adjustment or tuning operations. The receiver operates in the usual manner.

The converter unit measures approximately 1 1/2" x 2" x 4" and weighs less than a pound.

Complete details and prices on this



unit will be supplied by Waterproof Electric Company, 72 East Verdugo Avenue, Burbank, California.

## NEW VOLTOHMYST

The Test and Measuring Equipment Section of the RCA Engineering Products Department has just announced an advanced model "Voltohmyst" designed for the servicing of industrial and radio equipment using frequencies up to 250 mc.

Employing a newly developed diode probe and capable of measuring peak-to-peak voltages at very high frequencies, the new meter, designated as the RCA WV-75A, features circuit innovations which make the meter suitable for high frequency work.

The instrument comprises a v.h.f. voltmeter, audio voltmeter, a.c. voltmeter, d.c. voltmeter, ohmmeter and FM indicator. Special features of this unit include the ability to read both a.c. and d.c. voltages up to 1000 volts and an electronic monitoring circuit which makes the meter virtually burn-out proof. A polarity reversing switch which eliminates the necessity of changing leads is another new feature.

A full wave rectifier, built into the a.c. probe, makes possible the reading of both negative and positive voltage peaks even at the higher frequencies. The diode probe contains a standard



Army-Navy integral female fitting for direct connection to a coaxial line. Measurements at high frequencies are

## NEXT MONTH

### TRANSMISSION LINE SYSTEMS FOR FM AND TELEVISION HOME RECEIVERS

Servicemen must know the facts presented in this article to understand higher frequency antenna system installations.

### RETAILING BASICS THAT PAY OFF

A New York University Professor analyzes important facts for new and old dealers.

### A 5-TUBE HAM SUPER

Construction details of a low cost short-wave receiver.

### SIMPLE 10-METER CONVERTER

An easy method for adapting war surplus receivers to the 10-meter band.

### CAPACITY OPERATED RELAYS

Experimenters and builders of gadgets will find many applications for these circuits which are actuated by body capacity.



# CRONAME *Facilities*

FOR ELECTRONIC COMPONENTS  
AND FINE METALCRAFT

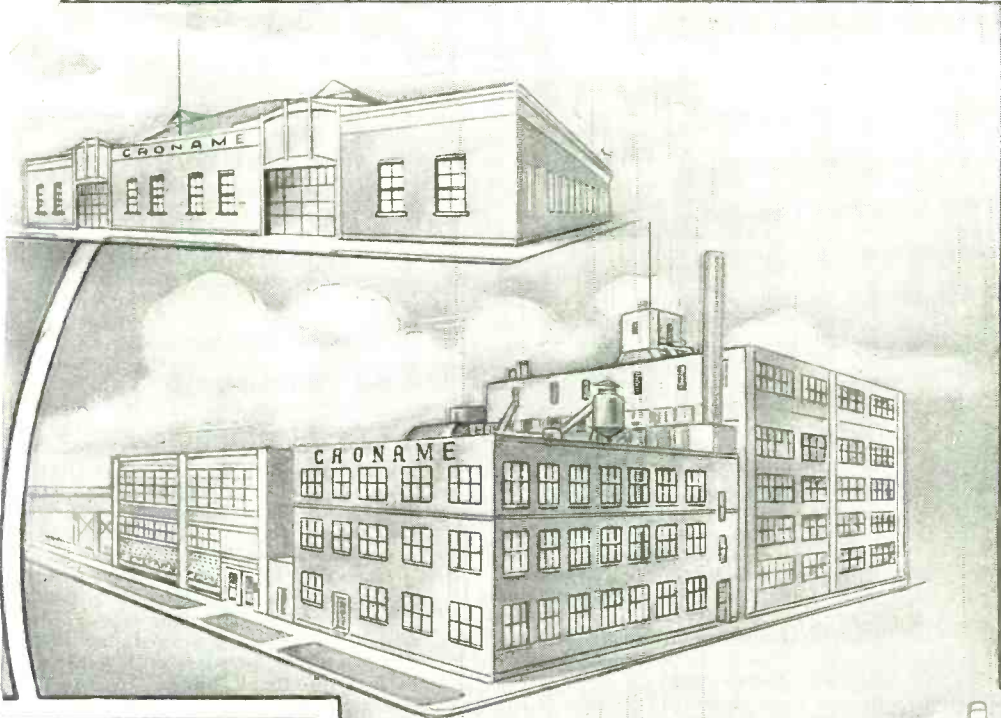

ENGINEERING  
ETCHING  
LITHOGRAPHING  
EMBOSSING  
ENGRAVING  
STAMPING  
ALUMINUM WELDING  
& HEAT TREATING  
ASSEMBLIES  
SOLDERING  
METAL FINISHING  
PLATING

ANODIZING  
PARKERIZING  
OXIDIZING  
FLUORESCENT  
PHOSPHORESCENT  
DECORATED GLASS  
GLASS DIALS  
DECORATED PLASTICS  
FORMED PLASTICS  
RADIO TUNING UNITS  
REMOTE CONTROLS

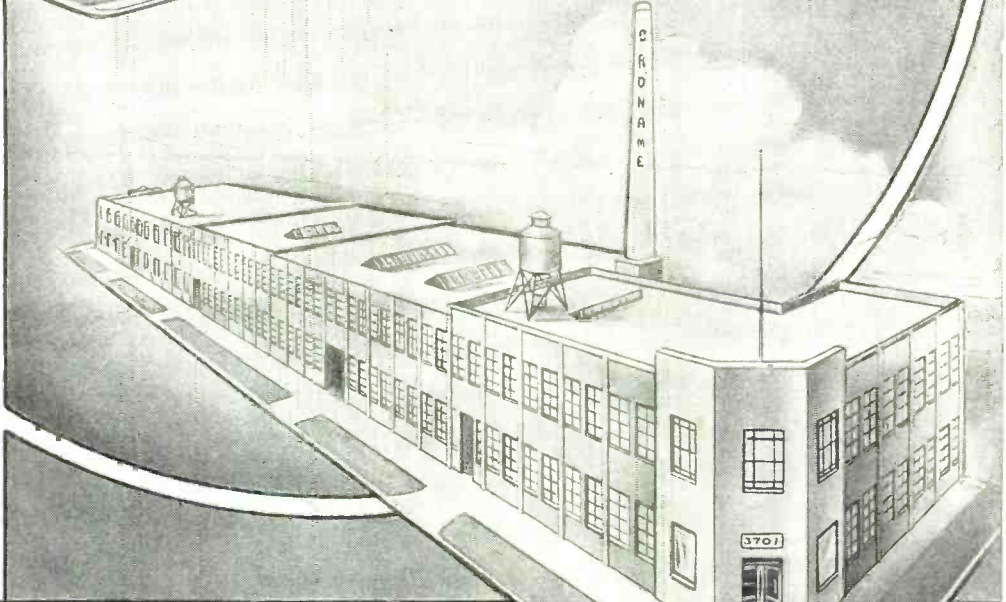

OVER 40 YEARS EXPERIENCE IN FINE METALCRAFT



**CRONAME**  
INCORPORATED

3701 RAVENSWOOD AVENUE  
CHICAGO 13, ILLINOIS





**ELECTRONICS**  
NEW (Not Surplus) MATERIALS



**AUTOMATIC IRON TESTER**

for setting thermostats. Meter calibrated to read directly — cotton, silk, rayon, linen, wool. Also calibrated in degrees 0° to 800° F.  
Checks opens and shorts and temperatures on most all types of appliances — complete . . . . \$24.95



**AMPLIFIERS**

- 5-Tube Guitar Amplifier with 12" speaker. Has 2 guitar and 1 micro inputs. Volume and tone controls, pilot light, and fuse. Assembled, complete . . . . \$42.95
- 3-Tube Guitar Amplifier with 8" speaker — complete . . . . \$27.50
- Kit of complete parts for assembly of 3-Tube PHONOGRAPH, including cabinet . . . . \$28.50



**PARTS BARGAINS**  
ALL NEW (NOT Surplus)

- 8 ft. line cords with plugs—50 for \$16.00 or 100 for \$30.00.
  - Condensers: .01-.02-.05-6000—\$9.00 per 100  
.01-.02-.05-4000—\$8.00 per 100  
Assorted as required. All values of condensers at comparable prices.
  - Resistors: 1/2 watt resistors—\$3.00 per 100  
1 watt resistors—\$4.50 per 100  
Assorted as specified by you.
  - Crystal Pick-up Arms — complete . . . . \$1.95
  - Hook-Up Wire, #22 solid push back, color coded, per 1000 feet . . . . \$5.60
  - GENERAL ELECTRIC METERS. R.F. Ammeter, 2 1/2" case, .0 to 1.0 Amp. . . . \$5.25
  - GRUEN METERS. 425UA-DC, 2 3/8" square case with multi-range dial. Make your own tester \$5.50
  - TUBES AT WHOLESALE PRICES:
    - 120 M. A. Power Transformers — 700 VCT, 6.3VC3.7A, 5VC3A . . . . \$3.50  
Many other items—send us your needs.
- ALL PARTS NEW (Standard Brands from Recognized Manufacturers.) — COMPLETE WARRANTY.  
All Prices FOB Los Angeles. 25% with order—Balance C.O.D.

**D H D ELECTRONICS AND APPLIANCE CO.**  
3025-R SOUTH FLOWER STREET  
LOS ANGELES 7, CALIFORNIA

made by direct contact with the central pin and the ground ring at the end of the diode probe, while an alligator clip for the central pin and the short ground lead serve as adaptors for voltage measurements at lower frequencies.

Details of this unit will be furnished by the *Test and Measuring Equipment Section, RCA Victor Division, Radio Corporation of America, Camden, N. J.*

**HARDWARE RACK**

Of interest to the radio serviceman is a new item which has been put on the market by *O-B Electronic Laboratories of Glendale, California.*

Known as the "ADA-RACK," this unit consists of 100 each of the ten most commonly used nuts and screws



handily attached to a rack which itself may be used as an additional shelf. This feature, combined with the fact that the rack may be attached to the wall, contributes to bench neatness and easy availability of the desired hardware.

Information on this line may be secured by writing *O-B Electronic Laboratories, Box 1137, Glendale 5, California.*

-30-

**MAKE YOUR OWN QSL CARDS**

**T**HE QSL card shown below is that of Auburn Esslinger, W8OZP in Owosso, Michigan. Mr. Esslinger operates mostly on the 75 meter phone band and his card is of particular interest because, by means of pictures, he has told a complete story of his country, state, city, home, operating table and himself, XYL and other points of interest which are used to make up the call letters.

Since others of our readers might wish to adopt Mr. Esslinger's technique in preparing their own distinctive QSL cards, the methods used are outlined briefly. The original card measured approximately 20 x 30 inches and was as white a cardboard as it was possible to obtain. This size was chosen because it was easier to take standard size negatives and enlarge them to a size that would make them proportional to the layout. Incidentally, the layout was drawn in very lightly in pencil on the cardboard first.

While the pictures used for this particular card were 3 1/4 x 4 1/4 inches and were taken with a Speed Graphic, other sized prints taken with any good camera are equally suitable. The choice of pictures and the actual design of the card are left up to the individual as there are many different ways that this material can be presented.

In printing the pictures for the card it is important that the correct grade or contrast of paper be used to keep all pictures on the same scale as far as the blacks, whites and greys are concerned. The pictures were fastened to the card with rubber cement as ordinary paste or mucilage causes the pictures to wrinkle or buckle.

All of the lettering was done with India ink. The pictures were all printed on glossy paper (single weight) as it was found in a previous attempt that this type of print made the best copy, as a dull finished paper usually shows up the grain of the paper. Single weight paper was chosen as it adhered to the surface of the card better than double weight paper.

The entire card was then photographed to give a postcard size negative which can be printed on double stock with a postcard back. Of course for those amateurs whose equipment or talents do not run along photographic lines, the entire job of printing pictures and photographing the completed card can be entrusted to a professional photographer.

Mr. Esslinger expressed a willingness to discuss further details of his card on the air or by mail. Inquiries should be addressed to him at 721 E. Oliver Street, Owosso, Michigan. -30-

"Personalized" QSL card which tells a story about Mr. Esslinger's home and hobbies.

Radio \_\_\_\_\_ Your \_\_\_\_\_ Phone \_\_\_\_\_  
On \_\_\_\_\_ Conditions \_\_\_\_\_  
Remarks \_\_\_\_\_



**OWOSSO, MICHIGAN, U. S. A.**

TRANSMITTER: 6L6 - 6L6-807-544-1125' 600W MWT  
SPEECH: 6C6-6C6-PUSH PULL 76' - PUSH PULL 1K250K  
MODULATORS: CLASS 'B' 203A' RECEIVER: 8ME 70.

Q.S.L.

*Auburn Esslinger*







# WHATEVER YOU NEED IN RADIO OR ELECTRONICS

PARTS...SETS...KITS  
TESTING EQUIPMENT...TOOLS  
PUBLIC ADDRESS EQUIPMENT  
TRANSMITTERS

## YOU CAN GET IT AT NEWARK!



### SERVICEMEN

Three big stores, each carrying tremendous stocks, are ready to serve you with tools, replacement parts, test equipment, sets or anything else you need. Wire, write or telephone if you can't visit one of our stores. If you can visit with us you'll find our trained staff of tremendous help to you.

### SERVICE

Mail orders are shipped the same day they are received. You don't have to wait when you buy from Newark. On special inquiries, we give you full information, prices and delivery dates promptly. Newark will give you service that will help you serve your customers better.



### PUBLIC ADDRESS SYSTEMS FOR EVERY NEED AND PURPOSE

No matter what your public address needs may be, Newark has the outfit that will do the job for you. All the well known, standard makes are carried in stock. Delivery is fast and dependable . . . in New York and Chicago we maintain our own delivery system . . . for out-of-town customers we ship orders the same day they are received.

All our stores are staffed by trained men who know public address needs and can help you select the outfit that will best serve your purpose. If your needs are unusual, they know how to make up special combinations to satisfy them efficiently.

If you can, visit one of our stores. If you can't come to see us, write, phone or telegraph and your inquiry will be answered promptly and fully. Newark has the stock, Newark has the 'know how', Newark can help you.



### BUILD YOUR OWN RADIO AND ELECTRONICS DEVICES AT LOW COST

With Newark's kits and parts you can easily build radio receivers, transmitters, amplifiers, and other exciting radio and electronics devices.

Make a good radio receiver for yourself or a fine record player with automatic changer at tremendous savings. You can construct these and many other radio and electronics devices easily. Our men know how to make them and will gladly show you if you can visit one of our stores—or will explain clearly by mail.

### FOR GOOD BUYS AND A GOOD TIME VISIT OUR BIG BARGAIN COUNTERS

These big bargain counters in all our stores, are loaded down with special items available in quantities too small to advertise. Marvelous war-time sets, new small gadgets you can have fun with . . . all sorts of new parts and special things you'll want to see. Come in, look around and ask all the questions you wish. Come in often you'll have a wonderful time.

### WRITE FOR OUR BIG BARGAIN BULLETIN LISTING THE LATEST AVAILABLE EQUIPMENT

Magazines are printed months before you read them, stocks change, new things are developed and made, so we give you the very latest news about the very newest things in radio and electronics in our Big Bargain Bulletin. Send for your copy today and know all about the latest equipment first. When writing address Dept. G3.



N.Y.C. Stores: 115 W. 45th St. & 212 Fulton St.—Offices & Warehouse: 242 W. 55th St., N.Y. 19



**SOMETHING NEW IN  
TEST EQUIPMENT!**

**THE FEILER TS-3  
SIGNAL TRACING  
"STETHOSCOPE"**



**Save Time...Earn More  
on Every Radio Repair Job!**

**GETS TO THE HEART OF RADIO TROUBLE IN A FLASH!** There's nothing like the FEILER STETHOSCOPE for saving service time—solves the toughest repair problem in minutes. To isolate and locate trouble, you just "listen in" on or "look at" the signal as it progresses through the circuit. Traces trouble at First Grid, R.F., I.F., Audio; tests parts; locates causes of mistracking, intermittence, distortion, etc. Features: 1" dia. aluminum probe with 3 ft. cable; Full 5" PM Speaker; R.F. vacuum tube voltmeter circuit provision for visual indication of R.F. voltages; Output meter provision; Headphone connection. In handsome brown-finished steel case with carrying handle; 8" x 11½" x 6"; wt., 10½ lbs. Operates on 105-125 volts, 50-60 cycles A.C. A professional instrument for the Service Engineer who wants the best at a moderate price. Complete with valuable Radio Service Guide.

**MODEL TS-3** Signal Tracing STETHOSCOPE for A.C. operation. Complete with 2-1T4 (or 1L4); 1-6K6 (or 6F6), and 1-6X5 tubes.

**ONLY  
\$34<sup>95</sup>**

**IMMEDIATE DELIVERY!** Place your order with your regular parts jobber. If he can't supply you, write for name of nearest local jobber stocking the FEILER STETHOSCOPE—or send your order to us direct.



**FEILER ENGINEERING CO. Dept. 1-A7  
803 Milwaukee Ave., Chicago 22, Illinois**

- Ship me one TS-3 STETHOSCOPE. \$..... enclosed.
- Send me FREE descriptive literature.
- Send name of local jobber stocking TS-3

Name.....  
Address.....  
City..... Zone..... State.....

# Depreciation and your Income Tax

By **HAROLD J. ASHE**

Tax Counselor

**Income Tax is a costly item. Save, by following the tips presented by this noted income tax counselor.**

**C**ONSIDERABLE confusion still exists in the minds of many businessmen as to how to treat depreciation in their income tax returns. Not a few are still ignoring depreciation entirely on certain depreciable assets, with the result that their taxes are greatly increased. Many others have set up or are continuing to set up depreciation schedules which do not conform to the rules laid down by the Internal Revenue Bureau. In the latter instances, such tables of depreciation are frequently challenged at later dates by bureau auditors.

One commonly held misconception is that if depreciation is not taken from the outset of acquisition of a depreciable asset, the taxpayer may not start taking such depreciation at a later time. He may take such depreciation in a current return, even though he has overlooked it in previous returns. However, the depreciation, contrary to another misconception, does not start as of the date he first takes depreciation, but starts as of the date the asset is acquired. That is, past "allowable" depreciation is gone, even though not previously taken. Third error is that taxpayers who have not previously taken depreciation, even though it was "allowable" in past income tax returns, ignore "date of acquisition" and "cost or other basis," misconstruing "other basis" as an invitation to value such assets at what their present new replacement value would be, a figure usually higher than the actual asset cost at time of acquisition.

As relates to Federal income taxes, depreciation is an allowance for exhaustion, wear and tear of property used in a trade or business, or of property held for the production of income. The purpose underlying allowance for depreciation is to permit the taxpayer to recover over the useful life of the property the capital sum invested therein. The terms "used in trade or business" or "held for the production of income" would include property held for such purposes, though actually not in use during the taxable year.

Taxpayers should not confuse fluctuation in value of an asset with depreciation. For example, a piece of equipment becomes second-hand at the moment it is first used and at least its resale value may drop appreciably

at that point. However, such a circumstance has no direct bearing on depreciation. Only that part of the loss in value which is due to actual exhaustion, wear and tear in business use, during the year, may be deducted as depreciation.

Neither are "obsolescence" and "depreciation" synonymous. Obsolescence is the reduction in value resulting from changes in circumstances that make it desirable or imperative that the property be replaced before it has been worn out, such as newer machinery that is faster, better or more economical than the old machinery. Annual depreciation is the loss which takes place in the course of a year.

If it is clearly shown that, because of economic or other conditions, property must be abandoned at a date prior to the end of its normal useful life, so that depreciation deductions alone are insufficient to return the cost or other basis, a reasonable deduction for obsolescence may be allowed in addition to depreciation.

"Complete exhaustion" does not necessarily mean the same thing as "useful life." If a piece of equipment, for instance, has a salvage or scrap value at the end of its useful life, this value must be taken into consideration in determining the depreciation rate.

A further requirement in determining depreciation is that the property must have a limited and determinable useful life in the trade or business. Land, for instance, upon which a building is erected, is not depreciable since it has no determinable life, and in setting up depreciation on real estate, the cost or other basis for the land must be segregated from the cost or other basis for the building. Thus, a building and land might represent an original cost at time of acquisition of \$20,000. If, however, a fair value for the land at time of acquisition was \$5,000, then the building's value at time of acquisition would be \$15,000, and the depreciation schedule would be based on the \$15,000 figure.

The length of useful life of a property is often difficult to determine. It depends upon particular circumstances, including the character of the property and its use. A well-built brick building may have a useful life of 50 years, and a frame building 25 years, a piece of machinery 5 or 10 years, a



# UNIVIBE... *The Universal Vibrator!*

8 TYPES  
SERVICE  
OVER 2500  
AUTO  
RADIOS



## N. U. AUTO RADIO VIBRATORS ARE BUILT FOR ENDURANCE!

1. Welded pole pieces for life-time adjustment accuracy.
2. Snug fitting synthetic sponge insulation for quiet operation.
3. Spot-welding of fingers, in contact against each other and the center reed, reduces voltage drop in center reed assembly.
4. Vibration proof adjustment by means of double-screw stack.
5. Pressure plate on top of stack keeps stack tight under tension over wide ranges of temperature.
6. Extra flexible roped wire leads eliminate strain and weakening.
7. Metal can, spun at bottom, seals vibrator against dust and dirt.
8. Plated pins assure minimum contact resistance.
9. Face of center reed weight is surface-ground to improve magnetic coupling.
10. Center reed uniformly stressed to prevent breakage.
11. Specially tempered reed and side contact arms.
12. Corrosion resistant silver-plated side contact arms.
13. Precision ground bakelite spacers for structural and dimensional stability.
14. Steel ring, molded into shock mount, centers and holds vibrator upright when can is sealed.
15. Neoprene wafer in hermetically sealed vibrators effectively seals vibrator against atmospheric pressure changes and moisture.

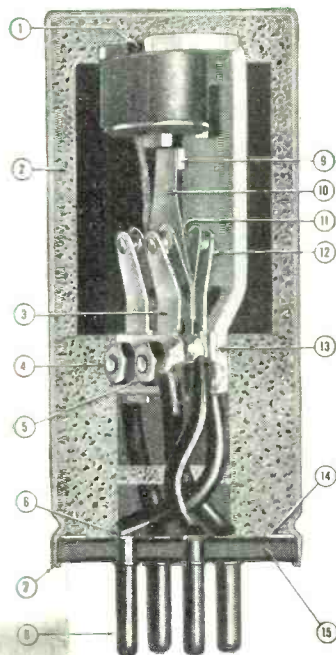

Typical Synchronous Vibrator Construction

## NEW LINE COVERS 97% OF ALL VIBRATOR REPLACEMENTS

UNIVIBE—the complete 8-model vibrator line—covers the replacement needs of over 2500 auto radio models! Provides quick, easy replacement of worn out vibrators in 182 makes of auto radios, as old as 1936!

Think of it—97% service coverage with only 8 fast-moving numbers—every one a repeat profit producer!

Yes, Univibe is right at the top in quality. Well known "balanced resonance" design, of extra heavy duty construction, means 33% longer vibrator life by actual test.

Here is another money-making radio parts line for National Union dealers.

For immediate delivery order Univibes today from your N. U. Distributor.

NATIONAL UNION RADIO CORPORATION, NEWARK 2, N.J.

# NATIONAL UNION RADIOS, TUBES AND PARTS

Receiving Tubes • Transmitting Tubes • Special Purpose Tubes • Cathode Ray Tubes • Radio Sets • Phototubes  
Panel Lamps • Flashlight Bulbs • Ballasts • Volume Controls • Condensers • Batteries • Auto Vibrators



# Build a Television

To stimulate its radio and television training programs, this famous resident radio and television school is offering men interested in television this unusual opportunity.



Instructor demonstrating rare Schmitt Optical System, used in big picture, projection type, television receivers. This famous television school's location in the heart of the television industry, helps it to get such scarce scientific equipment. At N.Y.T.I. of N.J. all types of television receivers are available for student study.

If you are unable to leave home to go to a resident school, N.Y.T.I. of N.J. can supply you with parts to build a television chassis in your own home. You will be supplied with the same instructions and directions with which the school's resident students are equipped, when they reach the stage in their training that calls for television set construction. If you already have a sound radio background, with experience in building radio receivers, you will be surprised to find how much you can learn about television by building this set.

N.Y.T.I. of N.J. is one of America's leading resident schools for men seeking dependable, thorough, up-to-the-minute training in the various fields of radio and television.

The schooling offered by N.Y.T.I. of N.J. is particularly useful to those who recognize the high-earning possibilities of technical training in radio and television and are willing to tackle the class and laboratory work offered, regardless of their previous education.

No high-school diplomas are needed for entrance. But N.Y.T.I. of N.J. requires that a student be earnest, sincere, and radio-minded. Students without proper mathematical backgrounds are taught the radio and

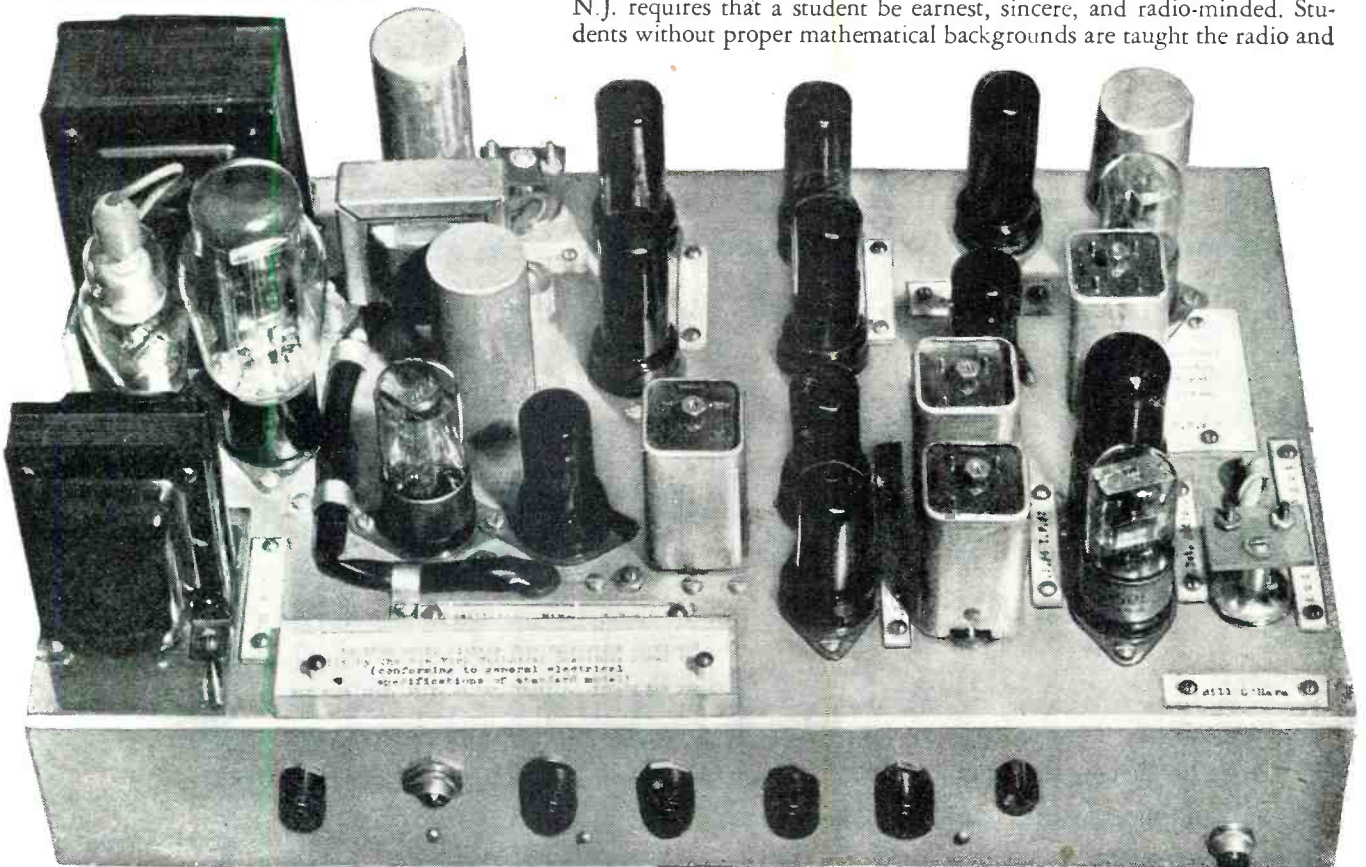

You can build a direct viewing television chassis similar to the one pictured above, either in your own home or in the magnificently equipped shops and laboratories of this famous television

school, located square in the HEART of America's television manufacturing and broadcasting industry. Mail the coupon at the right to get full details.



**MOST -  
OFTEN -  
NEEDED**

# RADIO DIAGRAMS

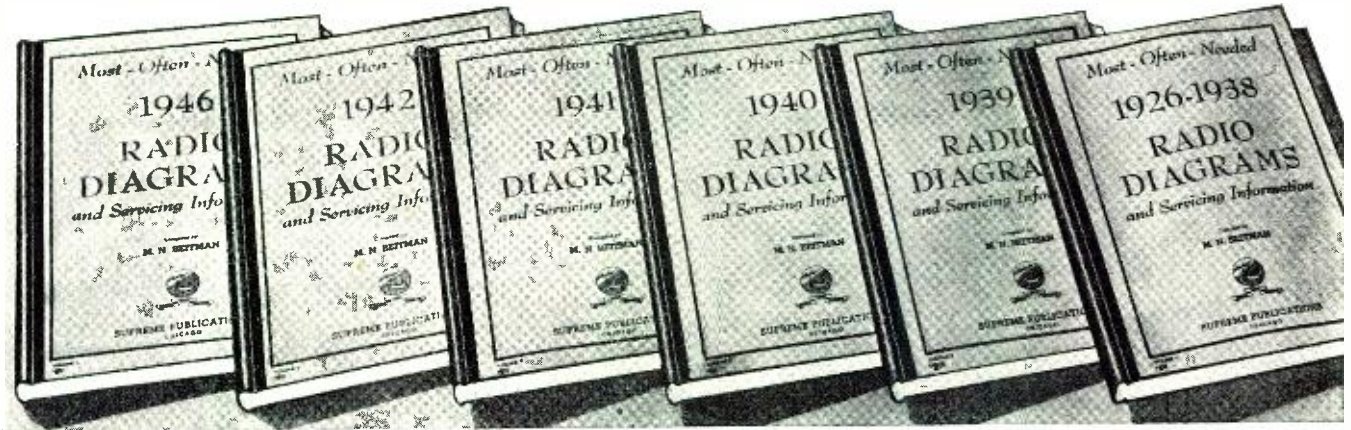

## 1946 4 OUT OF 5 DIAGRAMS YOU WILL EVER NEED

Find radio faults quickly. Make the needed repairs in any radio in minutes instead of hours. Save time on every job. This large, inexpensive diagram manual has the circuit for every popular 1946 radio set made since V-J day. Large manual, 8½x11 inches, 192 pages. Just out. Price postpaid, only..... **\$2.00**

**1942** Clearly printed circuits, alignment data, parts lists, service hints are the facts you need to speed up radio servicing. Repair radios quickly and properly—follow the factory instructions given in these manuals. 1942 Manual has 351 models of 40 large manufacturers. 192 fact packed pages. Large size, 8½x11 in. Manual style binding. Order manuals you need today..... **\$2.00**

## LOW-PRICED DIAGRAM MANUALS

### 1941

These easy-to-apply, inexpensive manuals will help you repair radios faster. This volume covers 1941 models, with alignment data, I.F. peaks, and replacement parts lists. Compiled by M. N. Beitman, radio serviceman for many years, author and teacher. Be an expert in radio servicing; simplify your work. **\$2.00**  
192 pages, 8½x11 inches. Only



### 1940

Let this important manual give you over 80% of all 1940 circuits you will ever need, acquaint you with new developments, train you to service quickly and efficiently millions of sets. Data on F.M., portables, recording, etc. 417 models of 43 manufacturers. 208 large pages of helpful data ..... **\$2.00**

### Most Popular Models Made By:

Philco, RCA, Zenith, Sears, GE, Emerson, Belmont Radio, Detroit, Fada, United Motors, Westinghouse, Arvin, Majestic, Stewart-Warner, Admiral, Delco, Stromberg-Carlson, Western-Auto, Sparton, Wards, Motorola, Gamble, and many others.

### 1939

Another handy manual of most-popular diagrams you need. Circuit data, hints and information are time-savers and money-makers for you. Let these diagram manuals guide you to easier service work. Why try to get along without helpful diagrams? Use this volume with 192 pages of diagrams of 39 makes. Order these manuals today. The 1939 Manual is priced at only..... **\$2.00**

### 1926-1938

The most popular volume of the series. Will pay for itself with the time saved during the first day of use. Includes all the popular old timers. Save hours on every job. 427 diagrams of the most-serviced radios of this period, with parts lists and alignment information. 240 pages, 8½x11 inches. Sold with a money back guarantee. Price..... **\$2.50**



Compiled by M. N. Beitman, Radio engineer, teacher, author, and serviceman.

### SAVE HOURS ON EVERY JOB

Be ready to make repairs in minutes instead of hours. You will be called upon to fix hundreds of models listed in these easy-to-use manuals. Tackle each job with the needed help found in these service manuals. Greatest bargain in diagram books. Send your order today. Plan to use these manuals this week.

## Other Practical Radio Manuals



### RADIO SERVICING COURSE

Learn new speed-tricks of radio fault finding, case histories of common troubles, servicing short-cuts, extra profit ideas. Many large lessons on the use of regular test equipment, explanation of signal tracing, television to the minute, recording dope. Many active servicemen used this reduced price radio training for brush-up and study of new service methods. Reprinted in 1945 with new information on signal-tracing, television, visual alignment, P.A., photocells, and every other fact you must know to be more expert in your work. Complete, 22 lessons, size 8½x11 in. With self-testing questions. Great bargain in home-study radio training. Postpaid, only..... **\$2.50**

### SIMPLIFIED RADIO SERVICING BY COMPARISON



New, revolutionary different COMPARISON technique permits you to do expert work on all radio sets. Most repairs can be made without test equipment or with only a simple meter. Many point-to-point, cross-reference, circuit suggestions locate the faults instantly. Covers every radio set—new and old models. This new servicing technique presented in handy manual form, size 8½x11 inches, 84 pages. Over 1,000 practical service hints. 24 large, trouble-shooting blueprints. Charts for circuit analysis. 114 tests using a 5c resistor. Six editions, 48,000 copies sold to date. Only..... **\$1.50**



### PRACTICAL RADIO MATHEMATICS

Introduces and explains the use of arithmetic and elementary algebra in connection with units, color code, meter scales, Ohm's Law, alternating currents, ohmmeter testing, wattage rating, series and parallel connections, capacity, inductance, mixed circuits, vacuum tubes, graphs, curves, the decibel, etc., etc., and has numerous examples. Low price, only..... **25c**

See Your Radio Jobber or Send Coupon →

# Supreme Publications

PUBLISHERS OF RADIO BOOKS, MANUALS, AND DIAGRAMS

## NO RISK TRIAL ORDER COUPON

SUPREME PUBLICATIONS, 9 S. Kedzie Ave., Chicago, Ill.

Ship the following manuals: (Money back guaranteed).  Radio Math  1946  1942  1941  1940  1939  1926-38  Radio Servicing Course.  Simplified Radio Servicing by Comparison  I am enclosing \$..... send postpaid.  Send C.O.D. I am enclosing \$..... deposit.

Name: .....

Address: .....



**HEXACON  
ELECTRIC  
SOLDERING  
IRONS**

**..tagged for  
the big jobs!**

TYPE P-150  
(illustrated)

MINNEAPOLIS  
HONEYWELL

Westinghouse

Bendix

STROMBERG  
CARLSON

Western  
Electric



Follow the leaders—and use HEXACON! For rugged, heavy duty work or for light intricate work . . . here's the answer. One reason is "Balanced Heat"—dissipating excessive element-impairing heat—and minimizing element burn-outs and tip replacements. Another is their lightweight. Literature is available describing the complete HEXACON line of screw tip and plug tip irons from 40 to 700 watts, and with tip diameters ranging from 1/4" to 1 1/4".

**HEXACON ELECTRIC CO.**  
119 W. Clay Ave., Roselle Park, N. J.

**HEXACON**

HIGH-QUALITY, LONG-LASTING SOLDERING IRONS

**Ring Oscillators**  
(Continued from page 50)

would be possible with only one or two triodes of the same type.

Lastly, this circular arrangement also permits, when desired, the use of u.h.f. triodes which are physically large.

For the foregoing reasons of stability, greater output power, higher operating frequency, and use of larger vacuum tubes—it is evident that these important advantages can be increased in magnitude by the addition of more and more pairs of triodes to the basic 4-tube ring oscillator.

**Large Ring Oscillators**

Any even number of u.h.f. triodes of the same type may be connected in this series-circular arrangement, known as a ring oscillator.

All of the previous circuit conditions for sustaining oscillations will apply to such multi-tube oscillators.

Leads between plates and grids of adjacent tubes connect to quarter-wave resonant lines, each of which is tuned to resonance by a shorting bar.

Oscillations take place because of unbalance due to standing waves on the Lecher lines, inherent inductive effects of the circular system, and feedback through the interelectrode capacitance of all tubes.

Use of a large number of pairs of triodes does not alter the fundamental circuit operation.

Output power of a ring oscillator increases almost linearly with the addition of each pair of tubes; a transmitter with 16 tubes having an output power of approximately 8 times that of a pair of the same type of triodes in a push-pull resonant-line circuit.

Maximum high-frequency limit of operation in the u.h.f. band is extended by the addition of each pair of triodes in a ring oscillator. This extension is somewhat logarithmic, but varies in degree according to the type and frequency characteristics of the u.h.f. triodes used in the circular circuit.

A typical ring oscillator, consisting of 24 triodes of the same type, is shown in Fig. 4.

Quarter-wave sections of resonant lines are used to tune the plate and grid circuits of every tube. Grid tank circuits are connected together by a *grid ring*—which is biased to r.f. ground. All plate tank circuits are also connected together by a *plate ring*. Plate voltage is applied through this output ring to all of the u.h.f. triodes.

Cathodes or filaments of the oscillating tubes should be operated at r.f. ground potential. At ultra-high frequencies of operation, bypass condensers would not effectively ground the filaments because of high reactance in the filament leads. For this reason, a half-wave section of transmission line—either resonant line, or

**It  
hurts  
us...**

When there are delays in filling your orders—due to abnormal conditions, such as wartime emergency, lack of materials, strikes, etc.—it hurts us more than it does you.

But now, the situation is improving and you can once again order from us with confidence . . . and get prompt and efficient Kenyon service.

THE MARK OF EXCELLENCE



**KENYON**

**TRANSFORMER CO., Inc.**

840 BARRY ST., NEW YORK, N. Y.

**This Month's  
Specials**

**At Greenwich Sales**

- UTC #VM2—Varimatch Modulation Transformer 120 Watts RF, 60 Watts Audio . . . . . \$7.00
- UTC #VA-4—Varipower Auto-Former. Output rating 1000 Watts. Permits output Voltages from 0-130 in 5 Volt steps. These units not new, but electrically guaranteed . . . . . 8.00
- UTC #S-36—Swinging choke—5-25 Henry—400 mhs, 85 Ohms. Brand new . . . . . 7.00
- UTC #303—Filter Choke—6 Henry—400 Mils . . . . . 6.00
- Grey Navy Case Power Transformer—PRI—115 V—60 Cy. 390-0-390 at 400 mhs. An exceptional buy. . . . . 3.25
- 4 1/2" 0-500 Mil Meter mounted in grey test case sloping front panel. 8"x8"x 8 1/2". Was used as special test equipment . . . . . 8.00
- JAN TUBES—9002, 9003, 9006, 951, 956 . . . . . each .65
- 6AC7, 6Y6G ea. 90c; 6J6, 2x2 ea. \$1.00; E1148—Same as HY615 \$1.00; 6C4, 5T4 ea. 75c; 5BP1 in original carton, with socket. . . . . 7.75
- SPECIAL C.D. Electrolytic—1,000 Mfd. 15 WV.D.C. \$1.00—6 for. . . . . 5.00

25% deposit required on all orders. Prompt delivery assured.

Write for Bulletin NR

**GREENWICH SALES CO.**

59 Cortlandt St. — Whitehall 3-3052  
New York City 7, N. Y.



# McGEE'S BARGAIN PAGE

## 1947 — COMPLETE RADIO KITS

**SENSATIONAL PEE WEE AC-DC KIT Model K-24K.** Size 6 1/2 x 6 3/4 inches. Very small in size, uses pee wee tubes 11A5, 1T4, 1N5 and 3S4 and new dry disc rectifier. Conventional superhet circuit with AVC; 2 gang condenser. Receives broadcast 550 to 1700 KC. This set when wired according to our diagram will make a hot little personal radio. This kit is priced complete; just as all our kits are, with tubes, cabinet and speaker; nothing else to buy. Net \$11.95



**5-TUBE AC RADIO KIT** Superhet circuit using new permeability tuning unit. Covers broadcast 550 to 1700 KC. Beautiful walnut cabinet 12x7x6 5/8" A5 PM speaker. Everything complete, includes 6SN7, 6SK7, 6SQ7, 61K6 and 5Y3 and diagram Model K-5A. Net \$16.95



**KIT K-7A** 7 tube AC superhet 550 to 1700 KC. Has push-pull audio stage with tone control and 6 1/2" alnico 5 PM speaker. Conventional circuit with AVC. Similar in appearance to model K-5A except has slightly larger cabinet. Everything complete including diagram and tubes 6SA7, 6SK7, 6116, 6SN7, 2-6G6, 6Y3. A real value. Net \$19.95

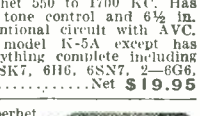

**6-TUBE AC DC KIT.** Superhet using permeability tuning. Covers broadcast 550 to 1700 KC. Walnut cab. 6x7x9. Everything complete including 1 u b e s 12SA7, 12SK7, 12SQ7, 35Z5, 50L6 and PM speaker and diagram Kit K-5. Net \$12.95



**KIT K-5B** farm radio superhet kit in same cabinet as model K-5. Uses permeability tuning rec. broadcast 550 to 1700 KC. Everything complete with 5" PM alnico 5 speaker and 11A5, 1N5, 1T4, 3S4 tubes, diagram less Batts. Net \$10.95

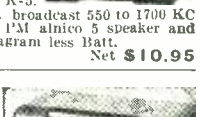

**DELUXE AC-DC KIT J-D5** Beautiful walnut cabinet and all the parts to build a broadcast 5 tube AC-DC radio. Superhet with slide rule dial, 2 gang tuning condenser and loop aerial. Everything furnished; includes speaker and tubes 12SA7, 12SK7, 12SQ7, 35Z5 and 50L6 and diagram. Kit J-D5. Net \$14.95



**OUR LEADER KIT \$9.95.** AC-DC 4 tube TRF kit 550 to 1600 KC Kit K-41L, a TRF job with a walnut cabinet and 5" alnico 5 PM speaker. All parts furnished; including tubes and diagram. Has direct drive dial and a very simple standard circuit. An ideal kit for the student or experimenter. Just a few hundred to sell. Very Special at only \$9.95

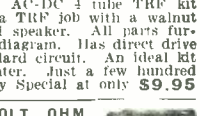

**MINIATURE POCKET VOLT OHM METERS.** D'Arsonval type meter. Best values you have seen in vom. ONLY 4x2 1/2x2" Bakelite panels, all metal cases. Model 450A has 1000 OHMS per volt sensitivity. Net \$9.75  
Volts DC 0-5/10/50/500/1000. Milliamperes DC 0-1. OHMS FULL SCALE 5000/50,000/500,000. OHMS CENTER SCALE 30/300/3000. Model 451B 2500 ohms per volt sensitivity. Has 24 ranges. Net \$15.15  
VOLTS DC 0-10/50/100/500/1000. VOLTS AC AND OUTPUT 0-10/50/100/500/1000. OHMS FULL SCALE 500,000. OHMS CENTER SCALE 7200. Model 452A has 10,000 ohms per volt sensitivity. Net \$13.65  
VOLTS DC 0-10/50/100/500/1000. OHMS FULL SCALE 2000/20,000/200,000/2,000,000. OHMS CENTER SCALE 30/300/3000/30,000.



**FLUORESCENT BED LAMP.** 110 Volt AC. All Plastic construction. Complete with 8 watt lamp. Offered in walnut or Ivory. Dealers. Net \$5.40  
Power supply to convert 1 1/2-90 volt or 2-90 volt farm and portable radio to 110 volt AC operation. Easily wired to set. Completely wired and tested; with tube and instructions. J-12. Dealers. Net \$5.95  
2 Gang condenser, oscillator coil and loop; all matched. Special \$1.95  
2 Gang condenser, 3/8" shaft, cut back section. Special \$1.49  
5 K-C. First and Second high gain I. F. Trans. Special \$1.49  
9 or 4 wire 450 oscillator coils. Each \$1.69  
Small loop antennas. \$1.39  
**PLASTIC CASE DRY CHARGED WET BATTERY**  
Fits G. E. Portables. Special \$3.49

### Save 30 to 70% on Vibrators

**WAR SURPLUS AND REGULAR CARTONED**  
Midget 4 prong 6 volt \$1.09, 10 for \$9.90  
Delco off set 4 prong 6 volt \$1.79  
Mallory 5 prong sync. 6 volt \$1.95  
Oak stan. 6 prong sync. 6 volt \$1.95  
Utah SP-55 off set 5 prong sync. 6v \$2.59  
Utah SP-62 reversible prong sync. \$2.59  
Sync. unit only, long leads 6 volt \$1.69  
1'ah SL-5 sync. unit with buffers. \$2.59  
Midget Radiant 6 prong sync. \$1.49  
32 volt standard 4 prong. \$1.49  
General Elec. 7 prong 2 volt sync. \$1.95  
Heavy duty 6 prong sync. for 30 watt 6 volt amplifiers. Special \$2.95

## McGEE RADIO CO.

1225 McGee St. KANSAS CITY, MO.

## LATEST IN PHONO-KITS

### High Power Push-Pull Amps

You can save money by assembling your own record players. All the kits listed below are complete; nothing else to buy. In 15 to 20 minutes any of these kits will be ready to sell to your customers.  
\*The model JT-5 high power push-pull 3 tube AC-DC amplifier is furnished with all record player kits complete; wired and tested and furnished with tubes and speaker. The push-pull circuit assures good base response even at low volume. For servicing convenience and connecting to pick-up, a schematic diagram is furnished.

**KIT J-15 SINGLE RECORD PLAYER.** Attractive ready cut walnut finished cabinet with latest 78 RPM phono motor and light weight crystal pick-up and \*JT-5 push-pull AC-DC amplifier and 4" alnico 5 PM speaker. This player will surprise you in appearance and performance. Kit J-15 Dealers. Net \$15.95 complete

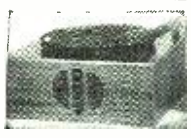

**KIT J-16 AUTOMATIC RECORD PLAYER.** Beautiful walnut finished, made to fit cabinet; latest single post automatic record changer and \*JT-5 high power push-pull AC-DC amplifier (wired and tested) and heavy duty 5" alnico 5 PM speaker. This kit makes a deluxe home record player. Kit J-16 Dealers. Net \$29.95 complete  
**KIT J-16A.** Same as J-16 except with leatherette base instead of walnut. Dealers. Net \$26.95 complete



**KIT J-17 PORTABLE SINGLE RECORD PLAYER.** Attractive tan leatherette covered portable case with latest 78 RPM rim drive phono motor and light weight crystal pick-up and push-pull AC-DC amplifier \*JT-5 (wired and tested) and 5" heavy duty alnico 5 PM speaker. A red hot special. Kit J-17 Dealers. Net \$19.95 complete

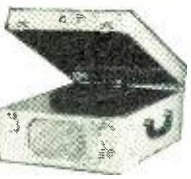

**KIT J-18 PORTABLE AUTOMATIC RECORD PLAYER.** Beautiful portable leatherette case and latest single post automatic record changer and \*JT-5 3 tube AC-DC push-pull amplifier (wired and tested) and heavy duty 8" alnico 5 PM speaker. We have sold hundreds of these to our dealers and they keep coming back for more. A real value. Kit J-18 Dealers. Net \$33.95 complete



**KIT J-19 SINGLE RECORD ATTACHMENT.** Attractive walnut finished base with motor cut out, latest 78 RPM rim drive phono motor and light weight, high output crystal pick-up. Easily attached to any radio or amplifier. Kit J-19 Dealers. Net \$9.95 complete  
Model B-4 phono oscillator (fits under base) Dealers \$3.69



**HOME RECORDER KIT J-10.** Dealers. Net \$59.95  
Consists of latest General Industries dual speed 33 or 78 RPM record-play-back mechanism. Beautifully made to fit walnut cabinet and a complete kit of parts to build a high quality recording amplifier with push-pull 6V6 outputs. All parts, tubes, 5" PM speaker, Astatic crystal mike and diagram furnished. This amplifier can also be used as a 15 watt PA system. Provisions made to connect 12" PA speaker. (12" G. E. PA Speaker and wall baffle \$1.95 extra) Net Kit J-10 \$59.95



### TWO-TUBE PHONO OSCILLATOR, \$3.69

Complete, wired and tested. 800 to 1500 KC. Model B-4. Has audio gain stage for proper power output. Complete with tubes ready to operate. \$3.69.  
Mike Oscillator model C-4 is similar to model B-4 except has added gain stage for crystal make. Complete with 3 tubes and fader control \$4.95. Crystal mike \$4.90 extra.



**ASTATIC CRYSTAL PICKUP WITH NEW NYLON NJI.** Cartridge and replaceable Sapphire needle. Very Special \$5.95

### WRITE FOR BARGAIN FLYER

When ordering send 20% deposit; bal. sent C.O.D. Canadian and American possession customers send full remittance and ample postage.

## BIG VALUES IN WAR SURPLUS

### ANOTHER HOT WAR SURPLUS SCOOP.

**ARMY BC-645 I.F.F. UNIT.** Net \$16.95. Early in the war, when radar picked up a plane, there was no way of knowing whether it was friendly or not. That was before BC-645 was invented. BC-645 sent out a signal that identified the plane as American. It probably saved more lives than any other piece of electronic equipment made. With some modifications the set can be used for 2-way communication, voice or code, on the following bands: ham band 420-450 mc., citizens radio 450-470 mc., fixed and mobile 450-480 mc., television experimental 470-500 mc. Equipment capable of doing the jobs of the modified set sells for hundreds and hundreds of dollars. The 15 tubes alone are worth more than the sale price. 4-7T7, 4-7117, 2-7K5, 2-6F6, 2-955 and 1-W6316A. It now covers 460 to 490 mc. Each BC-645 is shipped with a Belmont factory printed conversion diagram, showing how to make AC power supply modulator and how to make Transmitter and Receiver changes. Most Hams and experimenters already have the few parts necessary. New BC-645 with tubes less power supply \$16.95

**SENSATIONAL SURPLUS BUY.** BC-654-A. Transmitter-Receiver. 12 watt CW, 8 watts phone, 3500 to 5800 KC \$19.95. Used but in apparently good order. Offered with 3-307A tubes but less receiver tubes. The 7 tube superhet receiver has 2 RF stages. Designed for 1 1/2 volt octal tubes. Could be converted to heater tubes. Has built in 200 KC crystal calibrator. The 200 KC crystal and 2 1/2" thermocouple ammeter and 3 307A tubes are worth the price we are asking for the whole unit. First come first served. BC-654-A transmitter-receiver less power supply \$19.95

**WAR SURPLUS NEW SCR-522.** 100-156 MC Transmitter-Receiver. 4 Crystal controlled channels. 3 watt output on phones. Complete with 18 tubes, 2-332, 3-12A6, 1-6G6, 2-6S87, 1-12J5, 1-12C8, 1-9002, 3-9003, 1-12AH7 and 3-12SG7. New SCR-522 shipped with tubes, and 28 volt MG set. Simple conversion changes necessary are covered in October and November 46 issues of Radio News. This is a real value. BCR-522 \$66.95

**FM MOBILE ARMY TRANSCEIVER**  
2 channels 35 to 42 MC. 1 1/2 miniature 1 1/2 volt tubes and 6 spares. Vibrator power supply for either 6 or 12 volt Dc. Less crystals and top and bottom plate. Special \$24.95. Speaker \$4.95. Telephone hand set \$4.95

**1/2 VOLT OCTAL TUBES**  
Cost \$1.81 net on new prices save on Midget tubes and adapters  
1L4 and adapter to 1LE3 \$0.99  
1T4 and adapter to 1LE5 \$0.99  
1R5 and adapter to 1R5 \$0.99  
1L4 and adapter 1L4A \$0.99  
1R5 and adapter 1R4B, 1R4C \$0.99  
These adapters work right and save you real money.

**ADAPTERS AND TUBES**  
for less than price of tubes in regular 1 1/2 volt series  
1R5 and adapter to 1A7 \$0.69  
1R5 and adapter to 1R5 \$0.69  
1T4 and adapter to 1N5 \$0.69  
1L4 and adapter to 1A5 \$0.69  
3S4 and adapter to 1Q5 \$0.69  
3S4 and adapter to 3Q5 \$0.69

**40 MIL STANCOR POWER TRANSFORMER**  
Flush mounting 6.3, 5 volts. Special \$1.98

**12" G. E. SPEAKER**  
1 1/2 oz. Alnico 5. Beats anything you ever heard. Last \$16.50. Net \$9.50

**10" G. E. SPEAKER**  
1 1/2 oz. Alnico 5. Last \$13.50. Net \$7.50

**SCOOP ON ALNICO**  
5 PM Speakers.  
4" 1 oz. \$1.49  
5" 1 1/2 oz. \$1.59  
5" 1 1/2 oz. square \$1.69  
6" 1 1/2 oz. square \$1.95  
6" 1 1/2 oz. round \$1.95  
8" 1 1/2 oz. Alnico 3 \$2.95

**ELECTROLYTIC CONDENSERS.** Aluminum can, finest made.  
8 Mfd. 450 volt midket tubular \$0.39  
3x8 Mfd. 450 volt midket tubular \$0.69  
16 Mfd. 450 volt midket tubular \$0.64  
20x20 Mfd. 150 volt tubular \$0.59  
40x20 Mfd. 150 volt tubular \$0.69  
60x30 Mfd. 150 volt tubular \$0.79  
We guarantee these condensers for 1 year and are as fine as any produced. Money back guarantee.

**MASCO MC 25 P 110.** 6 volt Combination Amplifier with turntable ton is back in stock. Ideal for outdoor work. 1947 model. Complete with tubes. Amplifier only \$98.00  
**ASTATIC DYNAMIC MIKE** made for Uncle. Long deep throat design. Gray wrinkle and Chrome 20 ft. cord; swivel head. Ideal for all around P A work. Last \$25.00. Special \$10.95



# FREE



It's NEW, it's BIG, it's COMPLETE. It's Lafayette's latest, greatest catalog brimming with EVERYTHING that you want in Radio and Electronics. Radiomen and servicemen, hams and dealers, hobbyists and experimenters—this is the book for YOU. Mail Coupon!



Pages are crammed with standard items as well as all new developments. They're in stock—they're ready for super-speed delivery—they're priced for super-economy. If radio's your hobby, if radio's your business—if you're mild about it or wild about it—this is THE book!

IT'S YOURS FREE

## Lafayette Radio

RADIO WIRE TELEVISION, INC.

100 Sixth Ave., New York 13  
110 Federal St., Boston 10  
24 Central Ave., Newark 2

RUSH  
COUPON  
TODAY

LAFAYETTE RADIO Dept. RA-7  
100 Sixth Avenue, New York 13, N. Y.

RUSH your big new catalog to me by return mail.

NAME \_\_\_\_\_

ADDRESS \_\_\_\_\_

ZONE STATE \_\_\_\_\_

CITY \_\_\_\_\_

PASTE COUPON ON PENNY POST CARD

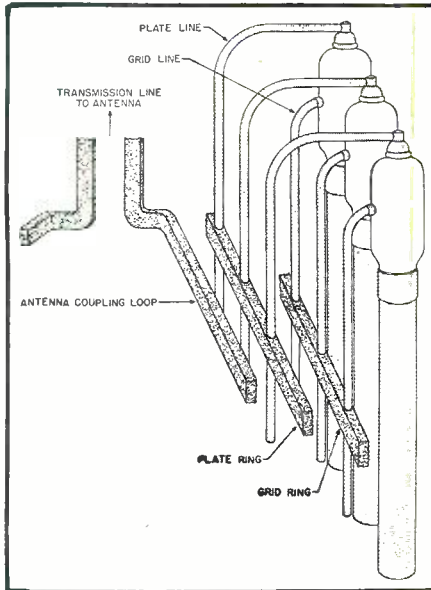

Fig. 5. Method of coupling employed in ring oscillator.

coaxial cable—is connected to each filament. The far end is shorted to ground, and transformer action of the half-wave line make this r.f. ground appear at the filament of the triode.

Since the plate ring is circular in nature, output power is coupled from it by means of a single-loop induction coil placed in the same plane as the plate ring.

The method of coupling and physical arrangement of components can be better understood by reference to Fig. 5, showing a portion of the construction of a typical ring oscillator.

Physical arrangement of the oscillator places all of the triodes in a circle, equidistant from one another. Plate tank circuits of each pair of triodes are constructed on the inside of the tube circle. If possible, the grid tank circuits should also be on the inside of the circle. The half-wave Lecher or coaxial lines used to tune the cathodes or filaments are generally enclosed in metal cylinders, and each triode is mounted directly atop its respective resonant line.

In the interest of space economy, grid and plate tank circuits are also mounted vertically. This arrangement places all of the shorting bars on approximately the same horizontal planes in somewhat of a circle, with the shorting bars of the plate circuits on a different plane and separated from the grid-circuit shorting bars. This separation should be more than one-half wavelength to prevent coupling between the two circuits.

In all the plate tank circuits current is maximum in the shorting bars, and flows in the same relative direction. Thus, the bars can be physically and electrically connected together. One arrangement (Fig. 5) connects all of the shorting bars together to form a continuous, circular metal ring. This plate ring shorts every plate tank circuit of the oscillator, and provides a single loop of current.

# A REAL SCOOP!

- Miniature extra-sensitive headphones—high or low impedance. Complete with matching transformer. Signal Corps type HS 30—wide frequency response ..... \$ 2.49
- 7 tube AC Superhet Kit—all parts, chassis, tubes, 6" speaker, instructions, diagram ..... 26.95
- .003 mica condenser, 2500 w.v. .... .25
- .0002 ceramic condenser, 700 w.v. .... .07
- .1 mfd. oil tubular, 600 w.v. .... .20
- Precision carbon resistors—1 meg.; 2 meg.—2W ..... .20
- Power transf. 117v. 60 cycles—850v. @ 125 m.a., 6.3v. @ 3A., 5v. @ 3A., half-shell mounting ..... 4.25
- Insulated carbon resistors. 1/2W-1W-100 ..... 3.95

Electronic Supply Corp.

40-14 Greenpoint Avenue, Long Island City 4, N. Y.

## FREE BOOK



ENDORSED BY CHAMPIONS

ACCURACY EFFICIENCY

The One and Only Candler System

Nothing else like it. It is the course that has made code champions. Will help any sincere man gain greater speed, accuracy and skill. Learn the Candler way. Get your copy of the Book of Facts for Code Students, Telegraph and Radio Operators.

CANDLER SYSTEM CO.

P. O. Box 928 Dept. 2-A Denver, Colo.

## 200 PIECE GRINDING KIT ASSORTMENT

For Industry & Home Shop

War Surplus—All New

- 10 ass'td. Grinding wheels with such famous names as NORTON—CARBURUNDUM, etc.
- 5 Cut off wheels ass'td. sizes.
- 5 Felt polishing wheels ass'td. sizes 1 to 2 inch
- 5 Round steel brushes with handles—ass'td. widths
- 10 Abrasive cloth cones ass'td. sizes and grits
- 2 Rotary files finest high speed steel
- 5 Mounted grinding points ass'td. on 1/8" shank
- 2 Steel Mandrels 3/32 and 1/8"
- 6 Felt Bobs square & pointed

And 150 other items for your shop. 200 piece complete assortment at sensation-ally low price of \$6.95 postpaid in U. S. Rush check or money order today.

GROBAN SUPPLY CO.

1522 S. Michigan Ave., Dept. RN-1. Chicago 5, Ill.

\$6.95  
Postpaid  
in U. S. A.

# Vasco

SUPREME QUALITY

TRADE-MARK REG. U. S. PAT. OFF.

ELECTRIC SOLDERING IRONS  
4116 AVALON BLVD., LOS ANGELES 11, CALIF.

## NEW! 12-in-1 Precision TOOL

Never before such a handy multi-use tool for pocket, home, office, shop. Nothing to open—nothing to jam. Includes 1. Screw driver 2. Adjustable nut wrench 3. Wire stripper 4. File 5. Alligator wrench 6. Staple puller 7. Glass cutter 8. Cap opener 9. Straight edge 10. Knife sharpener 11. Ruler 12. Magnet.

... all in one unit of fine tempered steel. You'll spend almost as much time POSTPAID \$100 showing it off as you will using it.

Bishop Engr. Co. 28 N. Clark St. Chicago 2, Ill.

RADIO NEWS



# NOW!

## You Can Make Your Present Radio Into An Advanced **FM** RECEIVER

with this Powerful New **1947**

# MIDWEST RADIO

**LOW**  
**FACTORY-TO-YOU**  
**PRICE**  
COMPLETE WITH  
SPEAKER

**SERIES 16\***  
**AM-FM**  
**CHASSIS**  
with  
**5 Wave Bands**



ONCE again Midwest demonstrates its 27 years of leadership with this powerful Super De Luxe Series 16\* 5-band world-ranging radio that brings you noise-free FM reception plus Standard Broadcast and 3 short wave bands. You'll be thrilled by its marvelous tone...its wealth of new post-war features...its world-ranging performance that brings you the finest programs with amazing clarity and strength. Send today for the new FREE 1947 Midwest Catalog before you buy any radio. Take advantage of our sensational Factory-to-you values and liberal 30 days Trial Offer.

**\*SERIES 16 CHASSIS USES ALL OF THESE LATEST TYPE TUBES**

**14 1/2"**  
**PANASONIC**  
**SPEAKER**

Plus the Exclusive **TRI-MAGNADYNE** Coil System — the Heart of Every **MIDWEST** in.

**30**  
**DAYS**  
**TRIAL**

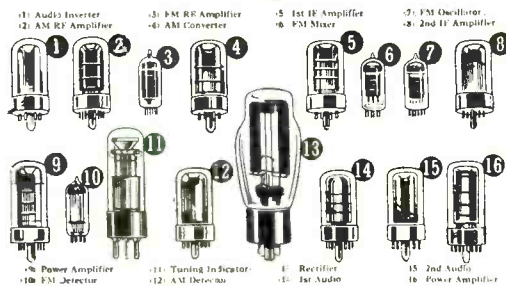

### THE MAGNIFICENT LINE OF BRILLIANT NEW CONSOLE AND TABLE MODEL RADIOS AND RADIO-PHONOGRAPHS



The **SYMPHONY GRAND** SERIES 16\* AM-FM RADIO-PHONOGRAPH CONSOLE with **NEW AUTOMATIC RECORD-CHANGER**

A REAL masterpiece of cabinet design and radio engineering... a luxurious musical instrument that brings you the newest marvels of radio science, including static free FM, automatic record changing, 5 wave bands and scores of new features and improvements for your listening pleasure. For complete details of this and other Midwest Radio models send for your copy of the 1947 Midwest Catalog today.

**Rush for Free Catalog!**  
FILL IN COUPON AND MAIL TODAY OR JUST SEND YOUR NAME AND ADDRESS ON 1c POSTCARD

**MIDWEST RADIO CORP.**  
Dept. 37-R 969 Broadway  
Cincinnati 2, Ohio

Gentlemen: Please send me your new FREE catalog and details of your liberal 30 Days Trial.

Name.....State.....  
Address.....Zone.....  
City.....

## MIDWEST RADIO CORP.

Dept. 37-B • 909 BROADWAY • CINCINNATI 2, OHIO

**RADIO MANUFACTURERS**  
Since 1920

**EASY TERMS**



**WE SHIP ANYWHERE  
IN THE WORLD**

*Internationally Famous*

**FLANAGAN RADIO  
CORP.**

**SEND FOR  
COMPLETE  
LIST OF  
AVAILABLE  
RADIO TUBES  
AND PRICES**



**AT FLANAGAN'S NOW  
The Sets You Have Been Waiting For  
THE FLANAGAN RADIO**



**A Delight to  
the Eye and  
Ear Alike!**

A Five Tube Superhet featuring: AC-DC operation; Standard American Broadcast and Police reception;

New easy-vision, slide-rule dial; High ratio Vernier tuning; Automatic volume control; Large dynamic speaker; Built-in Loop-tenna (eliminating outside aerial and ground).

**COMPLETE WITH TUBES  
WALNUT IVORY  
\$20.63 \$22.63**

List Price \$29.95 List Price \$32.50

**THE FLANAGAN COMBINATION  
RADIO & RECORD PLAYER**

**A MARVELOUS  
COMBINATION**



This Five Tube Superheterodyne presents a truly fine Radio Receiver and Record Player. It has all the refinements of modern engineering including a large electro-dynamic speaker and tone modulator. The Self-starting phono-motor with its new light-weight pick-up. All controls are conveniently located on the front of the handsome hand rubbed Walnut cabinet. Rich wood inlays and the distinctive grille give it a beauty that is fully in keeping with its splendid performance.

**COMPLETE \$42.50 List Price \$59.95**

**FREE CATALOG**

Send for free catalog and prices of hard-to-get Radios, Radio Tubes, Radio Parts, Pickups, Motors, Condensers, Tube Checkers, Volt and Ohm Meters, Signal Generators, Signal Tracers, etc. Please mention Radio News when writing.

**FLANAGAN  
RADIO CORP.**

Phila.'s Largest Stock of Radio Tubes  
N. E. Cor. 7th & Chestnut Sts.  
Phila. 6, Penna.—U. S. A.

Individual tank circuits can be tuned, as before, by adjusting the position of this plate ring or circular shorting bar.

A single-turn loop or coil placed in the same plane and within the circular plate ring will receive u.h.f. energy oscillations by inductive coupling. Coupling to the pickup loop is due to magnetic fields produced by currents in the plate ring.

In a somewhat similar manner, individual shorting bars on each of the grid tank circuits may be replaced by a single, continuous, circular metal ring (Fig. 5).

The physical arrangement of a multi-tube ring oscillator is considerably simpler than the schematic circuit (Fig. 4) would indicate. Despite its simplicity of construction, however, spacing and arrangement of all components of the oscillator are extremely critical of design.

The u.h.f. oscillator has only one disadvantage; it requires a large number of tuning adjustments. Grid rings, plate rings, and shorting bars in the filament circuits all require deft tuning at the resonant frequency of the transmitter. If adjustments are not made properly, considerable inefficiency will result.

However, this single disadvantage is offset by the symmetry of physical construction. Equispaced circuit elements and circular arrangement permit ganging of many tuning controls. For most types of the newer u.h.f. triodes, critical circuit adjustments are not necessary to sustain oscillations.

—50—

Antenna of Raytheon's Mariners Pathfinder radar test installation which was recently installed aboard the Atlantic Refining Company's "SS Atlantic Mariner." This installation marks the first time ocean-going American commercial tankers have been equipped with radar. The first run covered the Atlantic water route from Corpus Christi to Fort Mifflin. According to Captain Preston I. Williamson, ship's master, radar "took over" when a flashing buoy off Cape Hatteras failed to operate in marking position of a wreck.



**ORDER NOW**

- BC 312 Army Receivers . . . . . \$59.95
- Signal Corps I-222A Signal Generator  
Range 8-15 MC, 150-230 MC . . . . . \$69.95
- 300 Ohm Amphenol Twin Lead,  
per 100 ft. . . . . \$ 2.90
- 75 Ohm Amphenol Twin Lead,  
per 100 ft. . . . . \$ 2.00
- P-23 Army Head Set, 8000 Ohm  
with 5 ft. Cord and Standard Phone  
Plug . . . . . \$ 2.95
- 5" Communications Speaker to match  
BC 312, BC 348 etc. . . . . \$ 2.95
- 2" PM Speaker (Bakelite Cased)  
Used in Walkie Talkie . . . . . \$ 1.95
- Type 400 Advance—KW Antenna Relay. \$ 5.40
- Signal Corps Telegraph Key . . . . . \$ 1.10
- VT 127 Tubes (Equivalent to 100 TL) . . . . . \$ 3.50
- VT 232 Tubes (Equivalent to HY 615) . . . . . .98
- Jan 6 AK5 Tubes . . . . . \$ 1.95
- Jan 832-A Tubes . . . . . \$ 5.95
- Kilowatt 72 Ohm Amphenol Twin Lead,  
per 100 ft. . . . . \$ 7.20

Send for Our Special Bulletin of  
Government Surplus Items

**DOW RADIO**

1759 E. COLORADO PASADENA 4, CALIF.  
Pasadena Phone—SYcamore 3-1195  
Los Angeles Phone—RYan 16683



now you can

**SEE and HEAR** the signal  
with the new **CA-12  
Signal Tracer**



**FEATURING**  
Simple Operation...  
only one connecting  
cable... No tuning Con-  
trols. A new Superior  
Instrument Product.  
Complete with Probe,  
Test Leads, Batteries  
and Instructions.

Price 34.85

**NATIONAL RADIO DISTRIBUTORS**  
1029 E. 163rd St. New York 59, N. Y.

a **GOLD MINE** of  
**SURPLUS PARTS**

for **RADIO REPAIRMEN  
AMATEURS AND EXPERIMENTERS**

**12 lbs. of RADIO PARTS only \$2.00**

Relays — Condensers — Resistors  
Transformers — Coils — Hardware  
Wire, etc., etc.

Offered subject to prior sale. First  
come, first served. Write for Radio  
Parts Catalog. (Dept. A)

**ELECTRONIC PARTS, Inc.**  
622 W. Randolph St. Chicago 6, Ill.



**RCA Institutes, Inc.**

Offer thorough training courses  
in all technical phases of  
Radio and Television

WEEKLY RATES DAYS—EVENINGS

**VETERANS:** RCA Institutes is approved  
under G. I. Bill of Rights

For Free Catalog write Dept. RN-47  
RCA INSTITUTES, Inc.

A Service of Radio Corporation of America  
75 Varick St., New York 13, N. Y.





# How to Avoid Saving Money

by DANNY KAYE



To avoid saving money, the first thing is to cut off all your pockets. (Or throw away your purse and keep your lipstick in your snood.) Thus you will have to carry your money in your hand. Which will insure that you—1. spend it, 2. lose it, 3. get it taken from you—*quicker!*



Also to be avoided like crazy are piggy banks and sugar bowls. Keep these out of your home! The kiddies in particular are victimized by such devices, often saving quite a bale of moolah. Be stern even if the little ones cry—remember what money could do for them! And be sure to avoid budgets. It is best to draw your pay and walk down Main Street buying anything you don't particularly hate.

Above all, don't buy any U. S. Savings Bonds—or it's *impossible* not to save money! These gilt-edged documents pay fat interest—4 dollars for 3 after only 10 years! There is even an insidiously easy scheme called the Payroll Savings Plan by which you buy bonds *automatically*. Before you catch on, you have closets full of bonds. You may even find yourself embarrassed by a regular income! Get-gat-gittle!



IF YOU MUST  
SAVE

*Danny Kaye*

SAVE THE EASY WAY...

BUY YOUR BONDS THROUGH PAYROLL SAVINGS

Contributed by this magazine in co-operation  
with the Magazine Publishers of America as a public service.





**Famous LUCY RECEIVER**  
(KIT FORM)



This famous portable receiver designed for and used by the U. S. Secret Service. Paratroopers and the land and sea forces, is now available to you for the first time.

**6 TUBES INCLUDED**

Small, compact, ultra-efficient. No drilling or punching required. Complete wiring diagram supplied.

- Uses 6 Miniature Tubes 1R5, 1L4, 1S5, 3 1T4's in a superhet circuit
  - 2 Band Covers 2-12 Megacycles
  - Requires 90 Volts B & 1½ Volts A Battery
  - Iron core (456 K.C.) I.F. Transformers
  - B.F.O. for CW reception
- All Original Parts. Shipping Weight. **\$19.95**  
4 lbs. (Less Phones & Hookup Wire)

**SPECIALS**

2 MFD. 2000 V. Oil Cond. Ceramic Standoffs & Mts. **2 for \$4.25**

0-200 MILLIAMETER, D'Arsonval Movement—2¼" Sq. **\$2.95**

HAMMARLUND Super Pro. I.F. 456 K.C. Air-Trimmers. Constant Band-width ADJ. **2 for \$2.78**

30 M.C.—I.F. Slug-Tuned Shielded **2 for \$1.19**

Trans. Keron 115 V. A.C. 2.5 V. C.T. 10 Amp. 10,000 Test Volts. Limited Quantity. **\$3.89**

Code OSC. Kit. Key 1,000 Cycle Source. Wire—Hardware—Instructions. **\$2.69**

Ametran Sileor J-871 • Universal Hi-Fidelity Output Transf. Push-Pull or Single to 1½ ohms to 500 ohms—3"x3"x3½". **\$1.50**

Write For Quantity Prices.

**RACON - Dwarf Type**

Excellent For Paging, Marine, Handy-Talkies, Etc.



**\$4.75** Each

LOTS OF 10 **\$4.25** Ea.

- Pul Driver Unit—15 Ohm Impedance
- 5 Watt Nominal • Waterproof—Blast-proof
- Trumpet 12" long—5" Mouth

**WAVEMETER**

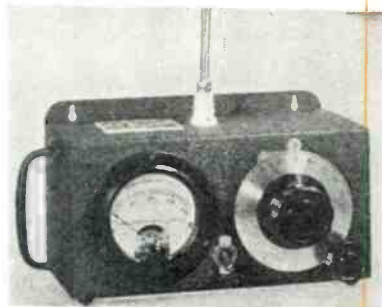

**FIELD STRENGTH METER**

- Contains 0-200 Weston 3½" Micro Ammeter
  - 70-90 MC Easily Converted
  - Spike Antenna • Calibration Chart
- LIMITED QUANTITY **\$13.75** EA  
**ALL MERCHANDISE GUARANTEED**

**International Short-Wave**

(Continued from page 60)

"The complainants appear to have overlooked the revised allocations of frequencies made at Cairo in 1939. Under the Madrid regulations of 1932, the whole band from 7000 kcs. to 7300 kcs. was reserved exclusively for amateur use, but under the Cairo Conference regulations, which became effective on September 1, 1939, the band from 7200-7300 kcs. was shared between amateurs and broadcasting.

"While, therefore, the BBC is justified in using these frequencies for its broadcasting services, it naturally does not wish to interfere with the activities of amateurs, and will always seek to avoid such interference by choosing frequencies in other broadcasting bands when these are suitable and available.

"As solar activity is now increasing, the BBC expects to be able to maintain its services to the Americas during the next few years without recourse to the 41-meter band, thus reducing to a minimum interference with amateur activity." (London Calling)

**News of the Clubs**

**AUSTRALIA**—I have just received a copy of "Skyrider," a publication devoted to the progress in DX, published by the *Australian DX Radio Club* with headquarters in Melbourne, Victoria. Gives present club officers as J. Hutchison, president; E. McGrath, vice-president; A. Canty, secretary; editors are E. Tinning, broadcast, C. R. Skoglund, short-wave and E. J. Miller, amateur. All correspondence regarding short-wave activities should be addressed to Mr. Skoglund at 32 McConchie Avenue, Kew, Melbourne, Victoria, Australia.

**DENMARK**—From Lund Johansen, Editor, *Populaer Radio*, Pilestraede 35, Copenhagen, comes word that the *Danish Short Wave Club* has recently been organized in that country. "I would be pleased to hear from DXers in any part of the world," Mr. Johansen writes. He sends out a monitor's card and offers Danish and other Scandinavian stamps to those sending in reports for use in *Populaer Radio* and the Danish short-wave bulletin, "Shortwave-Listener." Members of the new Danish club are seeking "pen pals" throughout the world. Further details can be had by writing to Mr. Johansen at the address given above.

**ENGLAND**—Sponsored by *Short Wave News*, the *International Short Wave League* has been formed in Britain. According to information just over from England, "The ISWL will cater for every class of short-wave enthusiast, be he constructor, listener, or transmitter. Entry into the ISWL is not hampered by any unnecessary restrictions, and there will be no varying classes of membership. For the present, membership fees are purely

**RADIO NEWS**

**KELVIN ELECTRONICS** 74 Cortlandt St. NEW YORK 7, N. Y.

**SILVER**

**NEW "SPARX" DYNAMIC SIGNAL TRACER**



New post-war design and construction, but low pre-war price, explains why wise service technicians buy it by the thousands. Matching "VOMAX", 904 Laboratory C-R Bridge, 906 AM-FM Signal Generator in size and style, "SPARX" is the same outstanding "buy". At only \$39.90 it will earn you, too, more profits than any other instrument you've ever bought.

Touch "SPARX" prod to grid, to plate, of every receiver circuit. You'll localize trouble in 30 seconds per tube—trouble in a five-tube receiver located in 2½ minutes! True dynamic signal tracing at r.f., i.f., a.f. — plus indication of presence or absence of a.c. and d.c. operating voltages, hum or distortion. Tests phono pickups, microphones, amplifiers, speakers—"SPARX" is your shop test speaker, too—all with visual and audible signal tracing. "SPARX", radio's complete signal tracer-tester, will earn its low cost for you in no time flat.

OVER 35 YEARS OF RADIO ENGINEERING ACHIEVEMENT

*McMurdo Silver Co., Inc.*

1240 MAIN ST. HARTFORD 3, CONNECTICUT

Send postcard for catalog of new measuring equipment, communication receivers, transmitters, kits and parts. See them at your favorite jobber.



nominal and are intended simply to cover cost of certificates, postage, address plates, and so forth. Membership identification numbers will consist of the letters 'ISWL,' followed by the prefix for locality coupled to an individual number, e.g., ISWL/VK234 would indicate a member in Australia. Until such a time as the membership justifies the publication of a separate League journal, news of the League will be carried in the pages of *Short Wave News*. "The First Annual has been prepared and should be out by this time; it is described as containing "a wealth of information for the DX listener" and as "the only book of the type and accuracy available" in Britain at this time. Arthur C. Gee (G2UK) is editor of *Short Wave News*, and W. Norman Stevens (G3AKA) is assistant editor.

Objectives of this new ISWL are described as: "To bring together the short-wave enthusiasts of the world, regardless of race, creed, or politics, to their mutual benefit. To foster and promote international goodwill through the medium of short-wave radio interest. To provide facilities which will enable enthusiasts to carry out their hobby to the greatest advantage to themselves and their fellow enthusiasts."

All communications regarding the ISWL should be addressed to ISWL, 57, Maida Vale, Paddington, London, W. 9, England.

The present Council of the *International Short Wave Club*, 100, Adams Gardens Estate, London, S.E. 16, includes A. E. Bear, secretary, and joint trustee with T. E. Port; members, T. A. Lidstone, Bob Cowell (G3WX), and Wing Comdr. Kenneth Jowers. (ISWC)

NEW ZEALAND—*The New Zealand DX Club*, Inc., has chosen as officers for the coming year: President, Stuart G. Bennett, 7 Rautara St., Orakei, Auckland; vice-president, Chas. McMillan; secretary-treasurer, Hank J. Barr, 10 Koraha St., Remuera, Auckland, S.E. 2; members of the Executive Committee are Mrs. M. Bennett, Mac Allison, Ted Bacon, James Dawson, Arthur Gunn, and Bill Mason. Merv Branks, 5 Dublin St., Invercargill, Southland, is editor of *DX-TRA*, monthly bulletin of the club;



"It's an idea John picked up while he was stationed in India!"

RADIO NEWS

# BETTER VALUES from ARROW!



## HICKOK 2½" 0-150 VOLT AC VQTMETER

Each..... \$2.49  
Lots of 10..... \$22.50

## NAVAL AIRCRAFT RECEIVER

Model BC-946-B

Broadcast Band from 520 to 1500 KC, tube complement, 3-12SK7, 1-12SR7, 1-12A6, 1-12K8; can be used with 24V dynamotor supplying A & B power; can be converted to AC or DC or 32 volt sets; 3 stages of IF used, uses 3 gang condenser, complete with tubes and schematic. Each..... \$12.95  
Dynamotor DM32A, each..... \$4.95

## SUPREME FOUNDATION METER

40 Micro Amps., 20,000 ohms per volt. 4½" square. Manufactured by Supreme Instruments Corp. \$8.95  
Each.....

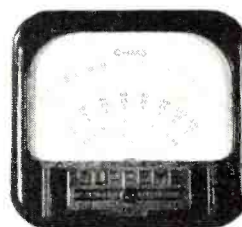

## SIGNAL CORPS RECEIVERS

6 tubes; 3-12SK7, 1-12SR7, 1-12A6, 1-12K8; 190-550 Kc. (specify freq. desired) 3-6mc power 28 VDC, mfd. by Western Elec. etc. Ship. wt. 19 lbs. Original cost \$99.23. Complete with tubes, whole \$6.95 receiver at cost of tubes only. Slightly used-your cost. Each..

### HEADPHONES

Signal Corps, 8000 ohms and 200 ohms, ea..... \$2.49  
Lots of 10..... 19.50  
2000 ohms Headphones, Triumm, ea..... 1.79  
Lots of 10..... 16.00

### SPEAKERS

EACH  
PM Alnico 4"..... \$1.60  
5"..... 1.65  
6"..... 2.25  
4x6..... 2.15  
6" extra heavy.... 2.85  
8"..... 3.85  
Dynamic 12"..... 6.95  
1000 ohm field.

### MICA CONDENSERS

All popular sizes. 100 assorted.. \$2.95

### 3½" G. E. AUTOMATIC TIME METER

60 cycle 110 volts. This time meter consists of a cyclometer driven by a telechron synchronous motor. Connect to an electric circuit; it will measure and indicate the number of hours, tenths of hours or minutes that the circuit is in use. Shipping wt. 6 lbs.—list \$17.00.  
Your Cost..... \$4.95

### KITS

Kit of 10 assorted volume controls up to 2 meg. less switch..... \$1.59  
Kit of 50 assorted knobs..... 2.85  
Kit of 5 to 20-watt resistors.... 1.89

### PICKUP

Los pressure crystal pickup \$1.95 ea.  
Lots of 10..... \$17.50

### PLUGS

PL55 Plugs..... 20c each  
Lots of 100..... \$15.00

### CARBON MIKE

T-17-B carbon mike.. ea..... \$1.49

Wholesalers, dealers, institutions and other quantity purchasers . . . write, wire, phone for quantity prices.

Dept. C

**ARROW SALES, INC.**  
59 WEST HUBBARD STREET • CHICAGO 10, ILLINOIS  
Telephone: SUPERIOR 5575



# GOVERNMENT SURPLUS

We have on hand a large selection of Radio and Electronic Equipment purchased from the United States Government, and solicit your inquiry on practically any equipment or component parts used by the Army or Navy. Listed below are only a few of the many items we now have in stock.

## Ampmeters, Analyzers, Antennas.

Bulbs, ¼ watt neon bulbs, screw base..\$ .20  
Bulbs, pilot, #44 & #47, box of ten..... .50  
Cases, receivers, 20 ¼x14 ½x11..... 4.75

Connectors, All Types, Write for Kind Desired  
Condensers, variable. National Type SSU, heavy duty, 7 plates, 50 mmf.....\$2.50

Converters, Crystal Test Sets, Coils, Dials, Vernier.

Frequency Meters, Fuse Holders, Headsets, Hand Telephone Receivers, Insulators, All Types, Ceramic, Standoff and Many Others.  
Jewel assemblies, large 45c; small.....\$ .30

Knobs, Loudspeakers, Microphones, Oscilloscopes 3 and 5 inches.

METERS: Weston Model #506, 2 inch, 0 to 150 DC MA.....\$3.00  
Phonograph hook-up wire, 15 foot roll... .25

## Plugs, All Types Amphenol, Phone, Cannon, Etc.

Potentiometers, all types.....35c to 45c

## Receivers, Range Calibrators, Rectifiers.

Resistors, asst. of 100—¼, ½ & 1 watt..\$2.25  
Relays, IXBM coil, 115 v., 60 cy., will carry 2 amps..... 1.75

Rotary Beam, Tower Equipment With Motor. Send for description.

Sockets, Steatite, 4 Prong. Dozen.....\$1.60

## Signal Generators.

Sockets, Johnson #247 transmitting.....\$ .60  
Suppressors, spark & distributor..... .10  
Switches, single pull D. throw..... .25  
Switches, single pull S. throw..... .25  
Switches, 4 pole double throw..... .65  
Tube cap assembly, large transmitting... .15

## TRANSMITTING TUBES

Test Equipment of All Kinds. Send for Current Offerings.

## TRANSFORMERS

High Voltage, Kenyon, type S-13336, for Scope, 6.3V.-6A, 2.5V.-1.75A, 2500V.-.015A.....\$5.00

FILAMENT: 115V. 60 cys. sec. (3, 4) 6.4V. at 1 Amp.: 8.1 W. Weeco #ESXX-683609: P/O Oscilloscope..... 1.30

FILAMENT: Kenyon, type S-13377, 115V. Pri. 5V.CT at 60 amp. sec..... 6.00

GENERAL PURPOSE: Power Transformer, Gen. Trans. Corp., type 6128; Pri. 115V. 60 cys. 3 sec. 300-0-300V; 100MA; 6.3V. at 5 Amp. 5V. at 3 Amp..... 3.00

We Have Large Inventory of Power, Plate, Filament, Audio and Others  
Send for Special Transformer Flyer

Naval Aircraft Receiver, ARC5, Superhet, Tubes—Included—3—12SK7, 1—12K8, 1—12SR7, 1—12AG7.....\$14.95

Naval Aircraft Transmitter, ARC5, 25 Watt CW; 15 Watts Phone. Tubes included. 2—1625, 1—1629, 1—1626, 1—6200KC Crystal Range LESS Dynamotor; Operates on 28V. Power Supply..... 9.95

## SPECIAL GRAB BAG OFFER

Over \$100. Cost of Miscellaneous Radio Parts, etc. Including Pilot Bulbs, Condensers, Resistors, Sockets, Insulators, Fuse Holders, Terminal Strips, Transformer, Volume Controls, and many other articles—A REAL VALUE FOR ONLY—\$10.00.

Add Postage to Above Prices

**THE ABELL DISTRIBUTING CO.**  
5 E. Biddle Street, Baltimore 2, Maryland  
Send for Our Flyer—Name Items Interested In

Arthur T. Cushen is the short-wave editor, and Keith Robinson, the BCB editor.

SWEDEN—From Halsingborg, Carl-Eric Petersson writes that DXers in that town have organized a new radio club, *Foreningen Nordvastra Skanes Radioamatorer*. The club has two sections, DX and "ham." President of the organization is Toge Paulson (SM7QE). The club has a monthly house organ called "*DX-News*," of which Mr. Petersson is editor. The club will use both Swedish and *English* in its publication. Address is Luleagatan 14, Halsingborg, Sweden (Sverige).

\* \* \*

## Verifications

Stations operating from Switzerland are now verifying with an attractive card. It features a map of Europe, with Switzerland stressed in red. The country is aptly referred to as "the heart of Europe." The reverse side gives details of frequencies of the Schwarzenburg transmitters. Address for reports is Swiss Broadcasting Corporation, Neuengasse 30, Berne, Switzerland.

"*Radio Maroc*" verified by letter (in French) for an Australian DXer and gave address as "Radio Maroc," Resident Dengeral de Republique de France en Morocco, Rabat.

Per Friis, Denmark, lists recent veries as WCBN, WCBX, KWID, KCBR, WBOS, FZI, VLA3, SEAC (Ceylon), CKLX, ZLT7, XGOY, XORA, OTC. (Incidentally, Per, who is 17 years old, uses a 1941 Philips 3-tuber with only one short-wave band.)

Recent veries received by Glynn Moss, Ontario, are from *Radio Paris*, XEQQ, XEBT, OTC, and HJDE.

Verifications reported by Bill Milne, New Zealand, include BFN, SDB-2, KRHO, WRUS, WRUL, *Singapore Radio* (6.77 and 11.735), VLR, CKLO, and XGOY.

Jean-Marie Gauvreau, Quebec, reports a verie from COKG, 8.955, Santiago de Cuba, which sent a postcard in color and a mimeographed letter (in *English*). Address, La Cadena Oriental de Radio, Palacio del Radio, Estrada Palma No. 658, Apartado 82, Santiago de Cuba, Cuba. Mr. Gauvreau also reports HI2T, 6.480, Monsenor Nouel, Dominican Republic. Verifies with a nice postcard in blue, white, and orange; address, La Voz del Yuna, Monsenor Nouel, Dominican Republic.

Received by Mervyn Laubscher, Johannesburg, South Africa, are veries from CKNC, VLG4, XGOY, FZI, HEF4, *Radio SEAC* (Ceylon), PCJ, ZFY, Cable and Wireless, Ltd. (*Radio Athens*), and KZRH. Mr. Laubscher reports that *Radio SEAC*, G.P.O., Colombo, Ceylon, recently at 8:25 a.m. on a Sunday (heard by him on 15.120 but now on 11.77 at that hour), presented a talk by the Chief Engineer (probably a regular Sunday feature) in which it was stated that QSL cards are now being sent out. Incidentally, the verie letter received by Mr. Laubscher from *Radio SEAC* was a

reply to his report on a test transmission on 9.520, heard June 7-8, 1946.

A verification card from TGWA, Guatemala City, Guatemala, lists frequencies as TGW, 640 kcs.; TGWA, 9.760 and 15.170; TGWB, 6.535; and TGWC, 1,520 kcs.; it was stated *these are frequencies TGWA is actually operating on.* (Cooley)

Late veries received by Ronald W. Gray, New Zealand, are from YV1RX, LRS, COBQ, CKLO, CXA19, CXA10.

\* \* \*

## This Month's Schedules

ALBANIA—ZAA, 7.852, Tirana, has *English* news at 4-4:15 p.m. (BSWL). This station is seldom heard in the United States; has bad QRM.

ANDORRA—*Radio Andorra*, on about 5.980 (varying), is sending a good signal most afternoons and early evenings; has *English* at 3:30 p.m. (Gauvreau).

AUSTRALIA—Recent changes effected by *Radio Australia*, as listed by August Balbi, Los Angeles, California, include VLG10, 11.76, 11-12 noon to West Coast and South Africa, replacing VLG, 9.58; VLB2, 9.68, heard 11:45 p.m.-12:45 a.m. to West Coast, replacing VLB8, 21.60; VLC4, 15.32, heard to 10 a.m. to Asia, replacing VLC6, 9.615, also heard to Britain, 10-11 a.m.

The evening beam to the Eastern U.S. and Canada is now heard beginning at 7:15 and closing at 8:30 p.m. over VLA9, 21.600, and VLC9, 17.840; *English* news is still read at 8 p.m. I note that both these stations now return at 9 p.m. with a "program for Australian Forces during the next two hours"; stations in the 25- and 19-meter bands, respectively, are announced as in parallel also; *news* is at 10 p.m.

East Coast DXers desirous of logging VLR2, 6.150, Melbourne, will find it a fair to good signal at 6 a.m. when news is given; others that can be logged, with *English news*, at that time include VLQ2, 7.215, Brisbane, weak, and VLW7, 9.520, Perth, excellent.

VLA4, 11.77, in the Forces' program, is usually a good signal in the East around 4:15-6:30 p.m.; announces VLC10, 21.680, VLB6, 15.200, as in parallel. (Ferguson, Beck)

VLR2, 6.150, appears to have lengthened its schedule recently; new sign-off is 9 a.m. (Dilg)

AUSTRIA—*Radioverkehr Actien Gesellschaft* stated in a letter to a Swedish reporter that they operate over KWS-1, 9.833, KWS-2, 12.212, KWS-3, 6.171, and KWS-4, 7.161, with power of 35, 2, 4, and 4 kws., respectively. The KWS prefix probably stands for "*Kurzwellen Sender*." (Gillett)

AZORES—"Emissora Regional Azores," 11.090, Ponta Delgada, is being heard well on East Coast, 3-4 p.m. (Harris)

BARBADOS—According to Charles Mohri, reporting from Rio Grande, Brazil, VPL6, 5.305, Radio Distribution, Ltd., on facilities of Cable and



Wireless, Ltd., Trinidad, broadcasts sports events and other items of public interest at certain times; no fixed schedule.

**BELGIAN CONGO**—A letter received from Institut National Belge de Radiodiffusion, Brussels, lists Leopoldville transmitters at OTC-1, 17.770; OTC-5, 9.745; and OTC-3, 9.380, being kept as a reserve; OTC series is 50 kws.; and OTM-3, 9.380, OTM-2, 11.720, with 7.5 kw., and OTM-5, 6.282, with 3 kw. (Ferguson)

**BELGIUM**—New Zealanders report picking up Brussels on 11.850 between 3:45-4 p.m.; poor signal. (Milne) Direct from Brussels, it is learned that Ruyssedele, 17.845, is used for telecommunication between Brussels and Leopoldville, Belgian Congo, 12:45-1:15 a.m., 5-6:30 a.m., 10-11 a.m., and 1-3:30 p.m., irregularly. (Ferguson)

**BRITISH BORNEO**—According to John A. Hunt (G2FSR/VS4JH), now in London, "no station has yet operated on the s.w. bands from any part of British Borneo, only amateur stations VS4JH and VS4RM, operated by myself until recently."

**BRITISH SOMALILAND**—*Radio Somali*, 7.126, operates on Tuesdays and Thursdays between 9-10:30 a.m. (BSWL) Has fair signal on Thursdays at 9:30 a.m. when it has *English* program. (Dilg)

**BULGARIA**—*Radio Sofia*, 9.350 (varying), is heard in Massachusetts at 3:30 p.m. with *English* news, through heavy CWQRM; weak signal. (Sternfelt)

**BURMA**—*English* transmission from Rangoon, 8:45-10:15 a.m., previously on 11.845, is now radiated on 9.540; usually has news just prior to closing down. (BSWL) Appears to be on 9.543 rather than 9.540, is badly jammed by VE9AI, Edmonton, Alberta, and *Radio Australia*, on 9.540. (Dilg)

**CANADA**—CHOL, 11.72, and CKLO, 9.63, Montreal (transmitter at Sackville, New Brunswick), sign off the European beam at 6 p.m.; last *English* newscast is at 5:45 p.m. (Balbi) VE9AI, 9.54, Edmonton, Alberta, is reaching out these days, being heard in Sweden between 8-9 a.m. (*Night-Owl*) CBRX, 6.160, Vancouver, British Columbia, appears to sign on now at 10 a.m. (Dilg)

**CEYLON**—*Radio SEAC* on November 4 moved its 100 kw. transmitter from 15.120 to 11.770 mornings. (Balbi) Official schedules just in from Colombo, confirming change at 7:30 a.m. from 15.120 to 11.770, are as follows:

*Main Programs*—7:30-10:30 p.m., 15.12 and 6.075; 10:30-11:30 p.m., 15.12; 11:30 p.m.-3:30 a.m., 15.12 and 6.075; 4:30-7 a.m., 15.12 and 6.075; 7:30 a.m., 6.075; 7:30 a.m.-12 noon, 11.77 and 6.075.

*Special Services* (Educational transcriptions and Indian Forces' Program)—10:30-11:30 p.m., 11.77 and 6.075; and 3:30-4:30 a.m., 17.77, 6.075, and 11.77 (alternative). These schedules "are subject to change, of which

# TOMORROW'S PRODUCTS TODAY...

**STOCK DELIVERY**



## TEST INSTRUMENTS

Compact — Accurate — Priced Right!

- Jeweled Meter • Range Selector Switch
- All multipliers bridge tested for 1% accuracy
- Zero adjustment—built in batteries
- Molded bakelite case only 3-15/16" x 2-7/8" x 2"



### MODEL 450A

Volt — Ohm — Milliammeter

A fine instrument having a sensitivity of 1000 ohms per volt.  
 Ranges: Volts DC, 0-5/10/50/500/1000;  
 Mills DC, 0-1;  
 Ohms full scale, 0-5000/50,000/500,000;  
 Ohms center scale, 30/300/3000.

NET complete with batteries **9.75**

### MODEL 451A

AC-DC Volt — Ohm — Milliammeter

A dependable instrument of wide utility—sensitivity 1000 ohms per volt.  
 Ranges: Volts AC, DC, and Output Ranges, 0-10/50/100/500/1000;  
 Ohms full scale, 500,000.  
 Ohms center scale, 7200.



NET complete with batteries **13.65**

### MODEL 451B

Same instrument as above but has 2500 ohms per volt sensitivity.

NET complete with batteries **15.15**



### MODEL 452A

Volt — Ohmmeter

A superb instrument—100 microampere meter gives 10000 ohms per volt sensitivity.  
 Ranges: Volts DC, 0-10/50/100 500/1000;  
 Ohms full scale, 0-2000/20,000/200,000/2 Meas;  
 Ohms center scale, 30/300/3000/30,000.

NET complete with batteries **13.65**



### MODEL 312

Volt — Ohm — Milliammeter

An economy pocket meter featuring a 2" moving vane meter.  
 Reads: AC-DC volts, 0-25 50/125 250;  
 Mills AC-DC, 0-50;  
 Ohms, 100,000; mfd. .05-15.  
 Jacks provide range selection.

NET Complete with cord and plug. **6.00**

## CONDENSER SPECIALS

Guaranteed first quality.

"The best at the lowest price"

Mfd.	Voltage	Net			
10	25	27¢			
25	25	36¢			
100	25	52¢			
10	50	32¢			
8	150	32¢	30/20	150	88¢
16	150	42¢	100/30	150	94¢
20	150	44¢	20	250	59¢
30	150	47¢	8	450	44¢
20/20	150	70¢	16	450	64¢

# Attention GI JOE!

Here's Your Opportunity to

## Start Your Own RADIO SERVICE SHOP

Complete Starting-in-Business Package Stacks at

TEST EQUIPMENT TUBES, PARTS, TOOLS **\$350 up**

Act quickly! Meet the pent up demand for radio service. Turn your special service training into a profitable business of your own. No fuss. No worry. Here's everything you need—\$350 up. Details upon request. Write, wire or phone.

## PHILCO BEAM OF LIGHT

Selenium cell only, no holder, postpaid **1.80**  
 (Puts new life in Philco Changers.)



"One with every car radio service job!"  
 Emergency trouble lite. 12' cord reaches anywhere on car. Insert plug in cigar lighter on any car. Gives light—where needed—when needed—a "natural" for installing and servicing car radios—use it—sell it to your customer—for added profit.  
 1 lighter line in box **2.50**  
 1 dozen **1.88 ea.**  
 2 dozen **1.67 ea.**  
 4 dozen **1.50 ea.**

## SHORT WAVE RECEIVERS



HALLICRAFTERS S-38 **39.50**  
 S40 (REPLACES S20R) **79.50**  
 HAMMARLUND HQ120X **161.40**  
 SPEAKER IN MATCHING CABINET **11.85**

20% deposit required on all C.O.D. orders.  
 2% transportation allowance on orders of \$25.00 or more accompanied by payment in full.

**RADIO SUPPLY & ENGINEERING CO., Inc.**  
 129 SELDEN AVE. DETROIT 1, MICH.



# LEONARD LEADING VALUES

## SIGNAL GENERATOR

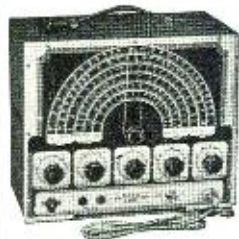

E-147  
**\$49.50** NET  
 RANGES FROM  
 100 kc - 75 mc

Multicolor dial has eight scales in color for easy reading. Large plastic pointer assures fine frequency tuning. Handsome gray crackle finish metal case is ruggedly built for absolute stability.

### 6L6 PUSH PULL OUTPUT 35 WATT

Completely shielded. Class AB1. Primary 6600 Ohms-Sec. 2-4-8-15-500 Ohms.

F-147 SPECIAL LIMITED QUANTITY \$3.89

### PLUG-IN ELECTRONIC CONDENSER

60-30-30 mfd 450 V.D.C.W.

G-147 SPECIAL LIMITED QUANTITY 83c

### ATTENUATOR

Impedance 100,000 Ohms Attenuation 3.0 DB per step to 57 DB then infinity at 388

H-147 SPECIAL LIMITED QUANTITY 89c

### PHONO MOTOR and PICK UP KIT

SPECIAL  
**\$5.95**  
 Complete



Crystal pick-up—Top quality constant speed motor.

### ELECTROLYTIC CONDENSERS

ETCHED—FOIL—CARDBOARD ENCASED—METAL ENCASED

8-450	38c	8-8-450	65c
16-450	56c	20-20-150	65c
30-150	40c	40-40-150	73c
40-150	42c	50-30-150	65c

Have a complete stock on hand of Sprague, Amperite, Aerovox, Bew, Turner, I.R.C., Shure, and other nationally known parts and equipment. Dealers and Servicemen supplied.

Send 10% deposit with order—Balance C.O.D.

**LEONARD RADIO INC.**  
 69 CORTLANDT ST.  
 NEW YORK 7, N.Y.

the only warning will be preliminary microphone announcements. The following additional frequencies are likely to be brought into use for the benefit of listeners in Malaya, Netherlands Indies, India, China, and Japan—17.77 and 9.520."

The 6.075 transmitter is heard in Sweden around 10:30 a.m.-12 noon sign-off. (Gilbert Andersson) Australians report the 6.075 frequency is paralleled by 6.180 (?) after 7:30 a.m.

CHINA—Australian sources say it has been almost conclusively proved that XGAP is the callsign of the Chinese station operating (probably from Kalgan) on 9.625; these letters are spelled out on opening at 5:45 a.m. and on closing at 9:30 a.m.; other callsigns are given during the broadcast period, apparently from stations in relay.

In the United States, reception from

the various Chinese transmitters appears to continue poor. XGOY, Chungking, on 11.920 (varying), is heard from around 10.45 to 11:45 p.m. sign-off; *English* news is scheduled for 11 a.m. On 9.640, XGOY is heard earlier in the morning to around 10:30 a.m. sign-off, *English* news is scheduled for 9 and 10 a.m.; is usually inaudible now  
 (Continued on page 140)

## Quality Before You Sell

(Continued from page 51)

for his family—not one too small that will give inadequate hot water nor one too large that will cost too much to operate. Thus your "Good Service" continues. During the sale you arrange satisfactory credit or terms; after the sale you take care of good

## EASILY CONSTRUCTED DUMMY ANTENNA FOR RECEIVER MEASUREMENTS

By GUY DEXTER

RADIO servicemen and experimenters who desire to make receiver tests and measurements in the approved manner often deplore their lack of a regulation dummy antenna for connection between signal generator and receiver. Such dummy antennas are sold by precision instrument manufacturers, but usually are designed mechanically to fit the attachments of a specific signal generator (usually costly) or are priced out of the reach of most non-scientific users.

Fig. 1 shows the arrangement of a dummy antenna that can be built easily by any radio man. The electrical circuit employed is the one specified in I.R.E. Standards.

The entire unit should be built into a small metal can. One of the popular 4" x 4" x 2" steel shield boxes used for ham instruments will make an ideal housing. Coaxial jacks are mounted directly on the box for efficient connection of the two shielded lines.

C<sub>1</sub> and C<sub>2</sub> should be the smallest-sized mica capacitors (such as Aerovox type 1469 or Cornell-Dubilier type 5W), in order to minimize capacitor inductive effects. Each capacitor must be selected carefully for exact capacitance. R is a 400-ohm, 1-watt carbon resistor (or precision non-inductive wire wound resistor) likewise selected carefully for exact value.

The 20-microhenry coil, L, is made by winding 34 turns of No. 24 enamelled wire on a 1-inch-diameter form. The turns are spaced to occupy a winding length of 1 inch. The coil form should be polystyrene, ceramic, or low-loss (mica-filled) bakelite. The dimensions

of the coil give it a good form factor. If a Q-meter or inductance bridge is available, the coil should be adjusted carefully for the exact 20 microhenry value. But if such a checker is not handy, the builder may strike the inductance value quite closely by adhering strictly to the winding directions.

All leads inside the dummy antenna case must be short. But the components must not be placed so close together that the capacitors and resistor come nearer to the coil than three-quarters of an inch. The capacitors must be mounted "on edge" so that their flat faces do not rest on the side of the metal box. This will reduce stray capacitance to ground. The coil must be mounted well away from the sides of the box, preferably in the center of the enclosure.

The coaxial line from the signal generator must be kept as short as possible. In fact, whenever possible, the dummy antenna case should be mounted on the front or side of the signal generator right at the latter's output terminals, in order to keep this connection short. The coaxial line to the receiver should not be any longer than absolutely necessary. A 2-foot length usually will be more than adequate to allow for moving the receiver about, tipping up on edge, etc.

A dummy antenna requires no adjustment nor manipulation. It merely is inserted between the signal generator and the receiver under test. It should be used when making all standard receiver measurements, such as sensitivity, image ratio, selectivity, etc.

—30—

Fig. 1

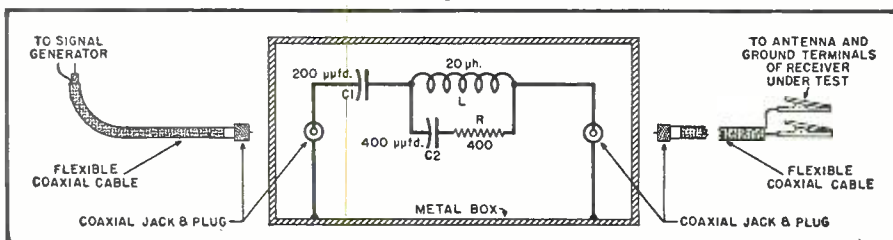



installation; then you maintain the product. All are "Good Services."

Your first duty therefore is to supply your customer with a good product. You, in the selection of your lines, must make sure that the radios and appliances you offer to your customers are well built, well designed, reasonable in price and will do well, the job for which they are intended.

There will be quite a few new manufacturers looking for outlets for their goods. Don't make the mistake of letting an extra five or ten per-cent discount be the deciding factor. The best ad for any radio or appliance dealer is a satisfied customer. You can't have satisfied customers with inferior products.

In my opinion, which was formulated primarily by testing all sorts of radios and household appliances, most nationally advertised appliances are good appliances. This does not mean that appliances made by smaller companies are no good nor does it mean that all products made by the larger companies are super products. It does mean, however, that the larger companies, as a general run, make good, easy-to-sell products and for the following reason.

1. Practically all, in fact all that I know, of the larger companies have extensive engineering departments and research laboratories for product development, refinement and improvement. These companies are continually working on their products to make them better.

2. The larger companies have excellent manufacturing facilities. For example, in refrigerator and range manufacturing such things as roll-welded frames and bodies make for far more sturdy construction than nut and bolt assemblies. Then, too, the bigger companies make larger quantities of any particular product and these production quantities tend toward economy of manufacture. This usually means a better product at the same price.

3. All of the large manufacturing companies have excellent testing, inspection, and quality control set ups. The quality of production in many cases is superior to engineering standards. Component parts are tested and inspected, sub-assemblies are tested and inspected, and finally the finished product is rigidly tested and inspected. I know of several companies that have a system of engineering check that is designed to insure uniform quality production. In the case of a refrigerator manufacturer, a certain percentage of the finished refrigerators are uncrated after production and completely checked by engineering. These boys know that they have a good refrigerator. They keep it that way by spending a lot of money on quality.

4. All of the larger companies have a very close coordination between service department, engineering department and production department. If at any time a number of field failures on a particular point are noted,

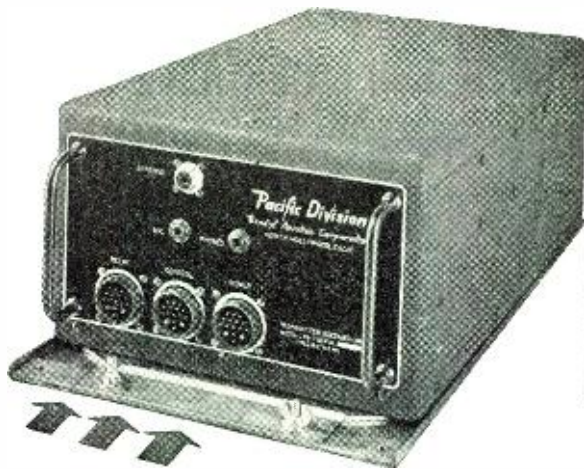

Photo courtesy Pacific Division Bendix Aviation Corp., North Hollywood, Calif. Transmitter-Receiver Unit for mobile communication equipment. Model LTR-1



## QUALITY ELECTRICAL CONNECTORS IMPROVE OPERATION AND SELLING FEATURES OF ANY EQUIPMENT...

An axiom of the electrical equipment industry receiving greater and greater acceptance is "No equipment is better than its electrical connections." Cannon Electric has long taken pride in furnishing connectors for quality equipment. These vital parts are recognized by manufacturers as "musts"—such as the Collins and Bendix new equipment shown here. Many other prominent firms specify Cannon Plugs because "Equipped with Cannon Plugs" means quality connections.

Two-channel Transmitter, 17E-2. Specially designed for executive planes.



Photo courtesy Collins Radio, Cedar Rapids Iowa.



\* All the connectors shown in the transmitters are type "K." If you wish a bulletin covering these fittings, write Cannon Electric Development Co., Dept. L-228, 3209 Humboldt Street, Los Angeles 31, Calif. for Type "K" Bulletin, or contact our representatives located in principal cities of the U.S.A.

**CANNON  
ELECTRIC**  
DEVELOPMENT COMPANY  
LOS ANGELES 31, CALIF.  
In Canada — Toronto, Ont.



**SINCE 1915**



# A NEW PRECISION BUILT PORTABLE RADIO



Custom Built, 5-tube, battery operated receiver with extremely good selectivity and sensitivity. Covers 2 bands—broadcast and medium short wave.

Mechanical construction is excellent. Hardware including handle, feet and panel are solid brass.

Receivers have been treated to withstand rigors or effects of all

climatic conditions and will perform excellently on either land or sea. Replacement batteries are standard type and can be replaced by any local serviceman.

PRICE—complete with batteries and tube:

**\$68<sup>00</sup>** Tax included

Terms: 25% deposit with order. Balance C.O.D.—f.o.b. Newark.

## AARON LIPPMAN AND CO.

246 Central Avenue

Newark 4, New Jersey

# HAM GEAR

## In Stock—NOW!

### RECEIVERS —

National • Hallicrafters • Hammarlund • RME

### TRANSMITTING TUBES —

RCA • Eimac • Gammatron • Taylor Sylvania • Amperex • Hytron • United

### METERS —

Weston • Triplett • Simpson

## ALSO

### FINEST STOCK OF

Transmitting Variable Condensers, Coils and Inductors, Transformers, Chokes, Insulators, Antenna Equipment, Exciters—and EVERYTHING necessary for building a Crystal Stage or an entire transmitter.

Write us for our Periodical Ham Bulletins on REAL Ham Values.

Mail and Phone Orders Our Specialty

## RADIO TELEVISION SUPPLY CO.

Dept. 11

1509 S. FIGUEROA ST., LOS ANGELES 15, CALIF.  
Phone: Richmond 9131 Cable Address: RATELCO

## RADIO-TELEVISION TECHNICIAN'S COURSE

- New Classes starting every 5 weeks.
- Either morning or afternoon classes. Full or Part time.
- Approved for veterans—Public Law No. 346 and No. 16.

Write for Free Bulletin on Courses

**HOLLYWOOD SOUND INSTITUTE, Inc.**

1040 N. Kenmore Ave., Los Angeles

--

MO 1-2345

## LES Correspondence Courses in RADIO and ELECTRICAL ENGINEERING

**ELECTRICAL ENGINEERING** Get good electrical field. Prepare yourself at Low Cost, for secure future. Modern course. So simplified anyone can understand quickly.

**RADIO ENGINEERING** Extra fine course in radio, public address, photo-electric work, training you to be super-service man, real vacuum-tube technician. Service needed badly. Diploma on completion.

WRITE Send postcard or letter for Free Copies of school catalogs, full details, all about deferred payment plan, etc. SEND NOW!

LOW \$25 Either AS Course

LINCOLN ENGINEERING SCHOOL, BOX 931-R97, Lincoln 2, Nebr.

130

## JOBBERS & MFRS.

Write for Our Giant Surplus Bulletin

KNAPP RADIO SPECIALTIES COMPANY  
827-833 Liberty St., Springfield 4, Mass.

the engineering department corrects the situation, and changes in the product are made to alleviate the condition. This too, makes for a better product.

5. All of the larger companies advertise their products. This makes it much easier for you to sell them. This advertising, in many cases, sells your customer before he comes into the store. Most of you know that the blame falls on you if the customer is dissatisfied with an unknown brand. If a nationally advertised product, in isolated cases, turns out to be a lemon, the purchaser is much more likely to forgive you and blame the right person—the person who made it.

The large manufacturer also offers advantages when it comes to service on appliances. Some of the reasons why this is so follow:

1. Most large manufacturers have many, centrally located service and parts depots. This enables you to obtain quickly needed parts, and in many cases the company service center will repair the defective appliance for you.

2. Practically all of the larger companies have complete service manuals and parts lists so that service on their products is greatly simplified.

3. Training classes for servicemen are held with the advent of new products. Color films and factory experts get the story across to your servicemen and make the job easier for you.

4. The service problem is continually being worked on by all of the larger manufacturers. They keep rigid records of all service calls and then design the products to simplify servicing. Remember the first automatic washers—it took several hours to replace a mechanism. Today, the same mechanism can be changed in about half an hour. These advances in design—pointed towards ease of service—save you much time and money in the long run.

The above seems to point out that the only safe course for a dealer to follow is to handle the products of a large, national advertiser. Strictly speaking, I do not mean that. The only way for a small manufacturer to get to be a large manufacturer is for him to get more dealers and sell more of his products. I repeat, "Many small manufacturers make excellent products." For the sake of your reputation, however, you should use care in picking the ones whose products you are going to handle. Get the answer to some or all of the following questions. If the answer is favorable there is no reason why you cannot promote these products and at the same time do a service to your customer and the manufacturer.

1. Will the product fulfill the manufacturer's or distributor's claims? This should be determined by test or through reliable sources.

2. Is the product well designed and constructed? This can be determined by comparison with proven products. Examine the construction, look for flaws or weak points.

3. Can it be easily serviced? Try

**RADIO NEWS**



removing and replacing some parts. You'll soon know if servicing is difficult.

4. Are parts readily available? Find out the location of the nearest source of parts. See if the stock is complete.

5. What selling aids does the manufacturer offer? Check the ease of selling against other products. Folders, leaflets, window displays, cut away models and many other sales promotion features help you to sell.

6. Is the company reliable? Find out if they can back up their guarantees. Make sure you don't put a lot of effort behind something that will be out of the picture in a short time.

If you are sure that the contemplated line will give you good answers to these questions, then go ahead. You can then, with confidence, tell your customer that he is buying a good product; you can tell him that you have checked and you know. Remember again, the easiest sale you can make is by having Mrs. Jones tell Mrs. Smith that she bought a good piece of merchandise at *your* store.

After you are sure that you have "Good Products" and "Good Service" most of your "danger signals" have been taken care of. There is, however, one more important one that you must watch with care. It is really possible to sell a person a good product, that can be easily serviced, and still wind up with a very dissatisfied customer. Always make sure that you check the mechanical and electrical requirements of the appliance you sell against conditions in the customer's home. For example, when you sell a refrigerator, make sure that the size is adequate for his needs and make sure the door swings in the right direction. When you sell an automatic washing machine, make sure that there is an adequate supply of hot water so the machine will operate efficiently. When you sell a water heater, make sure it is properly sized. When you sell an electric range, make sure that the range can be installed with correct wiring for proper operation. When you sell a radio, make sure you don't oversell. I have seen many oversized console radio sets in small living rooms. When you sell a man in a small house a radio with twenty or thirty watts of audio output, you are overselling him. Thirty watts of audio output will knock the plaster off the walls in most small houses. Normal reception, in most homes, requires just normal audio output. When you sell small appliances, such as toasters, irons, room heaters, waffle irons, sandwich toasters, etc., make sure that the purchaser's home is adequately wired for the use of these appliances. The main thing to remember is, you cannot have a satisfied customer if he does not get full use of the product he buys.

Make a list of questions on each product you sell. Phrase these questions so that when you get the answers you know that the customer can make full use of that which you sell to him. This, in the long run, leads to more business. If you refuse to sell a man

**AGAIN and AGAIN  
We Hear It Said**



**"KWIKHEAT  
THERMOSTATIC  
SOLDERING IRONS  
ARE THE BEST  
AT ANY PRICE!"**

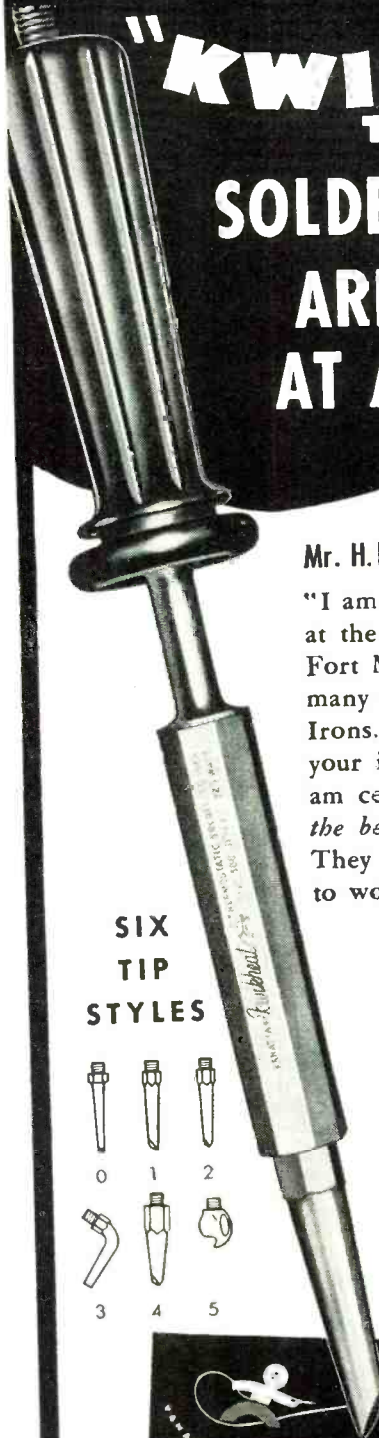

Mr. H.B.K. of Long Branch, N. J.\* says, "I am employed as a radio mechanic at the Signal Corps Laboratories at Fort Monmouth. In my work I have many times used Kwikheat Soldering Irons. I had never seen, nor heard of your irons until I came here, but I am certainly convinced that *they are the best irons that can be obtained.*" They (Kwikheats) are a real pleasure to work with.

\* Letter on file at our office

**SIX  
TIP  
STYLES**

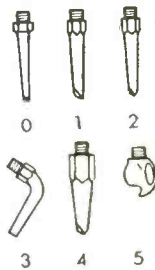

**CHECK THESE MANY  
KWIKHEAT FEATURES...**

- Thermostatic control
- Heats in 90 seconds
- Light weight (13½ oz.)
- Cool, protecting handle
- Six interchangeable tips
- Tips need less dressing
- Power cost reduced

225 - Watt List \$11.00  
450 - Watt List \$14.50

**KWIKHEAT**  
THERMOSTATIC  
SOLDERING IRON

A Division of  
Sound Equipment Corporation of California  
3903 San Fernando Rd., Glendale 4, Calif.



# UNIVERSAL RADIO SUPPLY CO.

## Immediate delivery



**CARDWELL**  
Heavy Duty Speaker

More than  
**150**  
**LEADING LINES**  
in our complete  
stocks. Latest  
technical data  
promptly sup-  
plied on request.



**PIERSON KP-81**  
\$367.65 Net  
Complete—  
20 Tubes

**CARDWELL**  
**CR-54**  
Delivery Est. May  
(Price on Request)



**HAMMARLUND**  
**HQ-129X**  
\$173.25  
complete



**HAMMARLUND**  
Super Pro  
SP-400X  
\$342.00  
complete



RCA DISTRIBUTORS

**ON UNIVERSAL'S STAFF!**  
W6 AGG  
W6 TAB  
W6 OXR  
W6 RKV  
W6 OHR  
W6 VCA

**UNIVERSAL**  
RADIO SUPPLY CO.  
1404 VENICE BOULEVARD  
LOS ANGELES 6, CALIF.

an automatic washing machine because he does not have an adequate supply of hot water, you are doing him a service. Sell him a good, adequate hot water heater first, then the automatic washer. Perhaps in these cases your competitor will sell the product to the same customer. I say—let him do it. In the long run you will be better off. Most people will listen to reason—just give your customer good reasons.

All dealers are in an excellent position to improve the standard of living of all America. Do the job well—it's not easy—it's hard work—but the rewards are many. Just remember—*"Be sure of quality before you sell."*

-50-

### Your Shop Location

(Continued from page 31)

you are specializing in ship radio repair, you must have your shop near where the ships are. If you specialize in auto radio repair, there is no better place to have your shop than in or near the biggest garage in town, for here will come the largest number of automobiles needing repairs of one type or another. Always remember that the servicing of auto radios requires sufficient parking space for the cars themselves. Try to locate a shop with a yard or courtyard in the back, and with an entrance for autos from the street.

There are two other thoughts which should be considered in determining the proper shop location. The first is to try to anticipate either a "business trend" or a "population trend" in the vicinity of the proposed location. Remember that the business you establish will have a certain amount of "good will." This "good will" is built up slowly, yet it may become your biggest asset. "Location" is usually an integral part of "good will." If you must move because of the location becoming unsuitable, some of the value of your "good will" may have to be sacrificed.

The other thought is that many shops have been built up on AM receiver servicing. However, the times change, and when you pick your new location, study the potential need for radio service on FM, television, home and industrial electronic devices, inter-com units, home recorders, etc. Study these needs in the light of the shop space and location best suited to their requirements.

To sum up, the location of a proper shop site for your radio service business should be picked with the following thoughts in mind:

1. You must know your particular need and pick your site accordingly.
2. Work up a clientele at home before you risk too much money in the rental of a store.
3. Be sure that you are ready to take on the responsibility of a store.
4. Know the territory you intend to serve. Learn its real estate values,

# RECORDS

## LATEST & HARD-TO-GET BACK NUMBERS

Some slightly used and some brand new—Victor, Bluebird, Columbia, Okeh, Decca, Capitol, etc. Such artists as Glenn Miller, Benny Goodman, Harry James, Bing Crosby, Frank Sinatra, Gene Autry, Duke Ellington, Fats Waller, Guy Lombardo, Andrews Sisters, Kate Smith, Ink Spots, Mills Bros., etc.

**BIG PROFITS** Your opportunity to cash in on this new field that is sweeping the country. Specify the type of music that sells best in your territory such as Swing, Sweet Music, Cow-boy, Hill-billy, Polkas, Blues, etc. Your price \$13.90 per 100 records, f.o.b. Chicago, 2% off for cash with order. All shipments made within 48 hours.

**CHAS. HOODWIN CO.**  
4419 Broadway, T-15, Chicago 40, Illinois  
World's Largest Dealers in Used Records

## ELECTRONIC VOLT-OHMMETER

**\$185**  
110 VOLTS AC 20 RANGES  
0.5/10/50/100/500/1000/5000 volts  
DC and AC. 0-1,000,000,000 ohms  
in six overlapping ranges. Sensitivity:  
over MILLION OHMS per VOLT on 5  
volt range.

**POSTPAID**  
Complete kit includes all component parts, tubes, punctured and drilled chassis and beautifully enameled panel. Easily assembled and wired.  
Special slideback circuit developed during war by scientist at the California Institute of Technology gives amazing sensitivity and flexibility while completely eliminating necessity of batteries and expensive meter. Each instrument is individually calibrated. Dial scale over nine inches long!  
In addition to performing the usual volt-ohm functions, this instrument easily measures these voltages: SUPERHET OSCILLATOR, AVC, AFC, TRUE GRID DIAS AT THE GRID, BIAS CELLS without affecting the circuit. Measures the exact leakage resistance of INSULATION, TUBES, CONDENSERS. It can be used with a signal generator for SIGNAL TRACING.

**STERLING ELECTRONIC COMPANY**  
Dept. 3  
166 N. Sierra Bonita Ave., Pasadena 4, California

## ELECTRICAL TRAINING

Intensive 32 weeks' residence course in fundamentals of industrial electrical engineering, including radio, electronics. Prepares for technician, engineering aides. Approved for veteran training. 54th year. Catalog.

**BLISS ELECTRICAL SCHOOL**  
7698 Takoma Ave.  
Washington 12, D. C.

## ELECTRICIANS! RADIO MEN!

Earn More Money!  
Get this new  
**GIANT SIZE**



**FREE TRIAL COUPON**  
Send with all shipping charges paid, your new COYNE Electrical and Radio Trouble Shooting Manual. Within 10 days after getting it I'll either return it or send \$3, then \$3 monthly until total of \$8.95 is paid. Cash price \$8.00—you save over 10%. Same 10-day free trial and return privilege.  
NAME \_\_\_\_\_  
ADDRESS \_\_\_\_\_  
CITY \_\_\_\_\_ Zone \_\_\_\_\_ STATE \_\_\_\_\_

Book Division, Dept. 17-T  
COYNE ELECTRICAL SCHOOL  
500 S. Paulina St., Chicago 12, Ill.  
Send with all shipping charges paid, your new COYNE Electrical and Radio Trouble Shooting Manual. Within 10 days after getting it I'll either return it or send \$3, then \$3 monthly until total of \$8.95 is paid. Cash price \$8.00—you save over 10%. Same 10-day free trial and return privilege.  
NEEDED BY WAR WORKERS, maintenance men, beginners, old timers. Nothing else like it. Saves time, helps boost your pay... **4 GREAT BOOKS IN ONE!**  
1. New Step-by-Step Trouble Shooting Course. 2. 500 Shop Prints. 3. Elec-Radio Dictionary. 4. Spare Time Jobs.  
**FREE!** 1 yr. Technical Counsel by mail from COYNE staff, on trouble-shooting problems.  
**SEND NO MONEY!** See offer below. Satisfaction guaranteed by famous COYNE "Learn-by-Doing" Electrical School. Rush coupon now!



its available stores, their relative advantages and their relative rentals.

5. If you intend to service only a portion of the town or city in which you have your business—locate your shop near the center of this area.

6. Check the type of businesses surrounding the shop site. Pick a store as near as possible to the heaviest flow of street traffic.

7. If you are interested in specialty repair service, place your site near other firms who cater to the same type of trade.

8. Check the flow of traffic during different hours of the day.

9. Look for other advantages including proximity to transportation stops.

10. Avoid enterprises that have "sales-killing" steps.

11. Watch to see what at the place you pick will "wear out." That is, see that the neighborhood will not change over the period of several years and in such a manner as to make your location unsuitable.

12. If you want to get into one or more of the newer electronic servicing fields, study your location to see that there is a need for these services in that spot.

If you take your time, watch your step and learn about store values, you should be amply repaid. Above all, don't think that the time spent on the solution to this problem is wasted. You will have few more important decisions in your whole business life which can be of greater help to your success—if answered correctly.

-30-

### TUBE REMOVAL

**M**OST every radioman has available or can make a wire "skinning" tool of the type illustrated, or of spring steel with "V" shaped notches in the bent over ends.

This tool is also useful in removing radio tubes as may be noted in the photo.

Metal tubes may be removed while warm with a tool of this kind without danger of burning fingers. H.L.



## THE CLARION MAGNETIC WIRE RECORDER Model A

The CLARION WIRE RECORDER is scientifically designed, carefully engineered, and will give full range fidelity in recording and reproduction. One reel of wire records, both voice and music for a full hour. The wire can be used indefinitely as recorded, or erased and reused countless times. Records from standard phonograph records and radio. Home or office recordings made with microphone. **ALL YOU NEED IS A RADIO OR AMPLIFIER!!**

#### SPECIFICATIONS

Record One Hour, Rewind 12 minutes. Frequency Response 30-8000 cps. Leader for simple threading of wire spool. Automatic erase, rewind, and stop. Plays standard phonograph records. Record or playback thru radio or amplifier. Operates from 110 volts 60 cycles AC line. High frequency oscillator for bias and erasing, operates at 40 K.C. Size: 9"x13"x6" deep. Weight: 15 lbs.

#### WE SUPPLY THE FOLLOWING

MAGNETIC WIRE RECORDER } In one Complete Unit as  
TURNABLE FOR DISC RECORDS } Illustrated  
CRYSTAL PHONO PICK-UP ARM }  
INDUCTION MOTOR  
Crystal Microphone  
One Spool of Wire  
Kit to build 40 K.C. Oscillator  
Schematic Diagram of Oscillator  
Schematic Diagram for connections to recording head  
for recording and playback Instruction Manual.  
PRICE FOB STATEN ISLAND, N. Y. .... \$97.50  
Additional Spools of Wire..... 5.50

Limit: One to a purchaser. No Radio Mfrs.—COD orders honored with \$50.00 deposit.

### ALL ITEMS IN THIS AD

*"Available Immediately!"*

#### CONDENSERS

Cat. No.  
C-120—1 mfd @ 400 volt, oil filled, rec can. 30c or 6 for \$1.50  
C-127—Triple 16 mfd. 1 350 volts Electrolytic. 65c  
Write for quantity discount  
C-121—Aerovox Type 1860 Mica .000025 @ 10,000 volts \$2.00  
C-122—Tobe Deutschman 8-8 mfd. @ 600 volt, oil filled, 4 prong, plug-in type \$1.50  
C-123—Cornell Dubilier Oil filled, Xmtg. 4 mfd. 1500 volt. \$1.75 or 2 for \$3.00  
C-124—1 mfd. 1000 volt, oil filled Cornell Dubilier 80c or 4 for \$2.50  
T-101—Daven Pads Type T-323-G. Impedance 600/600 ohms, attenuation 20 steps at 1.5db per step, max. att. 30 decibels. \$7.00  
T-103—Delta T Pads Centralab. 500 ohm carbon. Screwdriver slot shaft. Excellent for amp. and recording. 50c  
L-250—L Pad 40db attenuator—600 ohms, constant input imped. wire wound, 1 watt. 70c  
T-150—25000 ohm, 9 watts wire wound Rheostat. 30c  
C-150—Var. air-tuned hi-voltage capacitor 8-22mfd. Isolantite ins. suit. for neutralizing and tank. 40c  
F-105—Rayth. Filter Choke 8hy @ 60ma. Herm. sealed. 60c

Cat. No.  
F-102—Rayth. Filter Choke 25hy @ 65ma. Hi-volt Ins. \$1.15  
F-115—Filter Choke 50hy @ 370ma. Hi-volt ins. and Standoff insulators. Fully cased. \$4.75  
A-130—Television and scope Transformer. Pri-115-230v. 50-60 cps. Secondaries 355v @ 250ma, 710v @ 200ma, 1420v @ 170ma, 385v @ 20ma, 5500v @ 2ma. Half case. Mounting 18 color coded wire leads. 7"x6 1/2"x5 1/2" \$10.00  
A-131—866A Filament Transformer Sec. 2.5 v @ 10 amps. Pri. 0-110, 115, 120. Hi-volt ins. \$2.75  
M-103—Jensen NF101. Uses 5 1/2" dia. for mtg. 2 1/2" depth. 9 ohm voice coil. Hi-efficiency. Navy specs. for outdoor use. Ideal for paging system. \$7.50  
M-105—5-inch PM Speaker. \$1.75  
X-314—Telegraph Keys. Excellent for amateurs. 75c  
M-110—Western Electric Sound Powered Microphones. Complete with chestplate and 20' of high grade microphone cable, \$6.50; with 50' length of wire. \$7.50  
**BRUSH MAIL-A-VOICE Model BK-501.** Records magnetically on ferrous coated paper discs. Supplied with self-contained amplifier and microphone, for 110 volt AC 60 cycle use. Compact carrying case. Ready to record and playback. MAIL-A-VOICE recording discs may be folded and mailed. \$49.50

#### SEND FOR OUR BARGAIN FLYER

30% Deposit with COD Orders. Minimum order \$3.00. Many other items and specialties. Quality sound and recording equipment. Write us your needs.

## CLARION SOUND ENGINEERING CO.

363 VICTORY BLVD. STATEN ISLAND 1, N. Y.

GIBRALTER 7-8033



# CHASSIS?

A chassis is the basic part of any built up unit whether it is a transmitter, receiver, tester, or any other piece of apparatus in the fields of radio and electronic equipment. BUD chassis have, for years, been characterized by Beauty, Utility and Dependability. The sturdiest construction in 16, 18, and 20-gauge steel is found in the BUD chassis line.

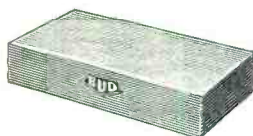

All of the standard sizes are found in the BUD catalog and are now on the way to your local distributor. See your local distributor and ask him to show you the complete BUD sheet metal line of chassis, cabinets, speaker cases, relay racks, etc.

## BUD Can Supply All Your Needs!...

... with the latest types of equipment including: condensers, chokes, coils, insulators, plugs, jacks, switches, dials, test leads, jewel lights, and a complete line of ultra-modern cabinets and chassis.



**BUD RADIO, INC.**

CLEVELAND 3, OHIO

# Manufacturers' Literature

Readers are asked to write directly to the manufacturer for the literature. By mentioning RADIO NEWS, the issue and page, and enclosing the proper amount, when indicated, delay will be prevented.

## AMATEUR RECEIVER

The new *Collins 75A* receiver, which has been specifically designed for operation on the amateur bands, is described in a new 4-page bulletin just released by the company.

The bulletin lists several features of this receiver and includes circuit data, control information, frequency coverage, bandspread, image and i.f. rejection data, selectivity, etc. in addition to a block diagram of the receiver.

A copy of the booklet which covers the 75A amateur receiver will be forwarded upon request to *Collins Radio Company*, Cedar Rapids, Iowa.

## ELECTRIC CONTROL DEVICES

In a compact, 8-page bulletin just released by *Ward Leonard Electric Co.* of Mount Vernon, New York, carries listings of a.c. and d.c. motor starters, speed and voltage regulators, resistors, ring and plate rheostats, switches, magnetic contactors, relays and dimmers.

Bulletin No. 100,000 is available for distribution to the readers of RADIO NEWS. Make your request direct to the company, *Ward Leonard Electric Co.*, Mount Vernon, New York.

## SOUND SYSTEMS CHART

Of particular interest to the serviceman who installs and services sound systems is the new chart issued by *Mark Simpson Manufacturing Company, Inc.*

The chart offers general suggestions for handling different types of installations, and makes recommendations regarding the size of amplifiers that should be used to service particular applications.

A copy of this chart is available from *Mark Simpson Manufacturing Company, Inc.*, Long Island City, New York.

## C-R OSCILLOGRAPH MANUAL

Although pertaining specifically to the *DuMont* Type 274 Oscillograph and designed to be used as an instruction manual, the new book "Operating and Maintenance Manual" issued by *Allen B. DuMont Laboratories, Inc.* contains much general information of interest to users of cathode-ray oscillographs.

The manual contains 39 pages of information plus a folded chart of the circuit schematic and constants of the Type 274. Several pages are devoted to the theory of operation of the cathode-ray tube and oscillograph circuits, complete with illustrations and diagrams.

Operating instructions deal with the

alignment of AM and FM receivers and the use of the oscillograph in conjunction with radio transmitters.

These manuals are available at a charge of \$0.50 each from the *Allen B. DuMont Laboratories, Inc.*, 2 Main Avenue, Passaic, New Jersey. Payment must accompany your order.

## ANTENNA EQUIPMENT

*The Workshop Associates, Inc.* have just issued a series of data sheets covering their line of antennas and antenna masts.

Included on the data sheets is information regarding the electrical and mechanical design of beam antennas, and dipole antennas for amateur applications. Antenna mast and mount, accessories for rotating masts and stand-off insulators are also listed.

Copies of these data sheets will be forwarded to interested persons upon request to *The Workshop Associates, Inc.*, 66 Needham Street, Newton Highlands 61, Massachusetts.

## REGULATED POWER SUPPLY

*Pan American Electric Company* of New York has announced the availability of a data sheet covering their regulated power supply, Model PAS-2000.

Included is application data, circuit design information, electrical characteristics, mechanical characteristics and a summary of specifications.

The regulated power supply described is suitable for use as a component for production testing equipment requiring stability of performance.

A copy of this data sheet will be sent upon request to *Pan American Electric Company*, 132 Front Street, New York 5, New York.

## SHURE CATALOGUES

The recently issued 1946-47 *Shure* catalogues, covering the company's microphone and pickup lines, feature several innovations in catalogue design which, according to the company, will facilitate the proper selection of equipment with a minimum of trouble.

Catalogue 155 illustrates the *Shure* line of microphones and features an article "How to Select the Proper Microphone" covering requirements, types, polar response, characteristics, and frequency response.

Catalogue 156 shows the line of "Glider" crystal phonograph pickups and lever-type cartridges. It also features an article entitled "Facts You Should Know About Pickups" which includes a discussion of needle-point compliance, tracking angle, tone arm mass, voltage sensitivity, type of

RADIO NEWS



needle, amplifier input circuits, and surface noise.

In both of these catalogues emphasis has been placed on readability and imparting detailed information on applications, technical data, construction, design, etc.

Copies of these catalogues may be secured from *Shure Brothers, Inc.*, 225 West Huron Street, Chicago 10, Illinois.

#### PARTS CATALOGUE

*Scenic Radio & Electronics Co.*, has just issued a new 16-page catalogue covering test equipment, sound apparatus, phonograph players, automatic record changers, speakers, tubes, microphones, antenna kits, radio text books, etc.

Listed in the test equipment section are volt-ohm-milliammeters, signal generators, tube testers, oscilloscopes, v.t.v.m.s., and signal tracers.

The company will forward copies of this catalogue free of charge to those requesting them from *Scenic Radio & Electronics Co.*, 53 Park Place, New York 7, New York.

#### BALLAST BULLETIN

The *JFD Manufacturing Company* of Brooklyn has recently announced the publication of a new a.c.-d.c. ballast bulletin.

This new 4-page booklet contains

complete listings of a.c.-d.c. ballasts for individual sets and a complete listing of the new, improved *JFD* air-cooled adjustable ballasts.

This booklet will be sent free of charge to those who request a copy from *JFD Manufacturing Company*, 4117 Fort Hamilton Parkway, Brooklyn 19, New York.

#### OLSON CATALOGUE

*Olson Radio Warehouse* has recently issued a new catalogue which should be of interest to radio servicemen.

Thousands of items are listed in this 32-page booklet including, microphones, amplifiers, intercoms, headphones, sound systems, speakers, record changers, pickups, and all types of radio components.

Copies of this catalogue are free for the asking. Address your requests to *Olson Radio Warehouse*, 73 East Mill Street, Akron 8, Ohio.

#### PRICE AND DATA SHEET

Electronic tubes for amateur radio applications have been listed in a new price and data sheet currently being distributed by the *Tube Division of General Electric's Electronics Department*.

The new sheet, ETX-19, has been introduced to facilitate the selection of tubes and provide a handy reference chart for all amateur applications.

Technical information and operating conditions data on over thirty tube types are contained in the new sheet. The information is presented in precise form and describes each tube available to amateurs from price to plate dissipation and power output ratings.

Distribution of the sheet will be handled by *G.E.* distributors or a copy may be secured from the *G.E. Tube Division*, Schenectady, New York.

#### ANTENNA SUPPORTS

*Wind Turbine Company* is distributing two data sheets which should be of interest to amateurs and servicemen readers of this magazine.

Information is furnished on several types of FM and television antenna supports as well as specification on a rotary beam antenna support for a four element 20-meter array.

Copies of these data sheets will be supplied upon request to the *Trylon Tower and Antenna Division, Wind Turbine Company*, West Chester, Pennsylvania.

#### ELECTRO-VOICE BOOKLET

One of the most valuable features of the new *Electro-Voice* catalogue, which has recently been released, is a page devoted to an easy-to-read guide to the selection of the proper microphone for specific applications. Listed



## Ham Specials

EVERYTHING IN RADIO, ELECTRONIC, AND COMMUNICATIONS SUPPLIES

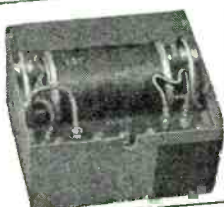

**DYNAMOTOR**  
12 VOLT DYNAMOTOR. 235 Volts output at 90 mils. Complete with filter, mounted in can 6 1/2" x 5 3/4" x 3 1/2" with cover, used but perfect.  
**SPECIAL \$2.95**



**VT-127A/100 TS TUBE**  
This Triode is capable of full output up to 600 MC; a pair will take a kilowatt input with exceptionally high efficiency. Plate dissipation is 100 watts; Rating-Class C Telegraphy; Plate Voltage—2500 V; Plate Current 200 ma; Grid Voltage 150 V; Grid Current 25 ma; Filament Current 10 a; Filament Voltage 5V; Amp Factor—15.  
**Special \$3.25**  
Special MYKROY SOCKET for above tube..... \$1.25  
HEAT RADIATING CAPS for VT 127..... 2 for \$1.25



**JAN 829B/3E29 TUBE**  
AND SHIELDED ALUMINUM SOCKET. Has built-in by-pass condensers. Both for the price of the tube socket.  
**Our Price \$6.95**



**FULL WAVE SELENIUM RECTIFIER**  
Perfect for bias application—Use your DC relays from an AC source. Only requires 3" x 1 1/2" mounting space Rectifier for input up to 300V @ 40 ma output.  
**\$.89 or 5 for \$4.00**

**PLATE TRANSFORMER**  
6200 Volt CT—700 Mils. 110 Volts, 60 Cycles tapped Primary 2 KVA AMERTRAN.  
Freight Prepaid Any Part of Continental U. S.  
**\$39.95**



**ANTENNA CHANGEOVER RELAY** for all bands—insulantite T.P.D.T. Plenty of contact surface.  
**\$2.75**

**ANTENNA CHANGEOVER RELAY.** Leach Type 1357. DG—13F—DPDT—plenty of spacing—mounted on low loss bakelite  
**\$2.50**

**1000 KC XTAL precision AT** Cut mounted in standard holder  
**\$4.95**

**10 ASSORTED TRANSMITTING MICA CONDENSERS.** All well-known brands designed for high Voltage. Assortment your price  
**\$1.98**

20% Deposit with order. Balance C.O.D.

#### CW3 RECEIVER

**CW3 RECEIVER** (used for aircraft monitoring) a fixed receiver (1100 KC to 16,500) xtal controlled superhet with BFO and AC power supply; 110V, 60 cy; Coils can be furnished in any of the following groups: 1100-2100 KC; 3500-6100 KC; 5600-10,000 KC; 9400-16,500 KC; complete with add. set of tubes and one set of coils  
**less xtal \$32.50**



G.E. PYRANOL 2mfd 4000 Volt filter 23F47 ..... \$5.50  
G.E. PYRANOL 4mfd 2000 Volt filter 22F66 ..... 4.25  
CD DYKANOL 2mfd 2000 Volt ..... 2.49  
AEROVOX FILTER CONDS. 6mfd 1500 Volts ..... 2.25  
WESTON—No. 476—0.130 Volt AC 3 1/2" Meter; special ..... \$4.95  
All Prices F.O.B. our Warehouse N.Y.C.

#### MODULATION TRANSFORMER

Perfect for input up to 300 Watts—Class C loads on secondary No. 1, 14000 Ohms—Secondary No. 2 is designed for screen of Tetrode or Pentode—primary will match 811, 809, TZ20 or TZ40 Tubes. Complete factory specifications and circuit diagram included)  
**\$4.95**

**W.E. DRIVER TRANSFORMER CLASS B**—matches 6L6 in Push Pull to any Class B formers. Perfect match for above Transgrids. Perfect match for above Transgrids.  
**\$3.95**

W2BNW is in charge of our ham Department

Write for our latest Bulletin 12-RN.

# NIAGARA RADIO SUPPLY

160 Greenwich St., New York 6, N. Y.



## SPEED UP REPAIRS WITH THESE G-C AIDS!

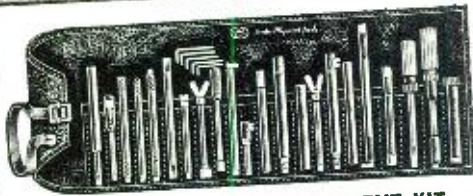

### G-C PROFESSIONAL ALIGNMENT KIT

Here's a complete Alignment and Neutralizing Kit in handy roll-type leatherette case that contains all the tools necessary to service any set—thirty finely machined tools that will save many man hours and do the job the professional way. The right tool is always at hand.

No. 5024.....  
List Price \$19.95

Send for latest  
G-C Catalog  
No. 147



### G-C HELL BOX

Thousands of assorted small parts such as screws, nuts, bolts, washers, clamps, lugs, radio and electric parts packed in neat metal box. A real treasure chest of those little parts the service man is always looking for.

No. 6500.....List Price \$4.00

### G-C DELUXE HARDWARE LABORATORY

Convenient steel rack, designed to hang on wall or stand on bench, contains over 2100 essential Electronic Hardware items, packed in 40 clear glass jars with screw caps. Ideal for laboratories, radio service shops, factories, experimental labs, home work shops, etc.

No. 6604.....List Price \$24.00



**GENERAL CEMENT MFG. CO.**  
ROCKFORD, ILLINOIS

in chart form, this guide specifies 26 different applications for which microphones are needed and then indicates which type of microphone would most likely be best suited for that particular use.

In addition to listing data about 22 types of microphones, this 19-page booklet also carries a section devoted to a brief summary of the technical information pertinent to the operation of the various types of microphones.

Copies of this catalogue, No. 101, are being distributed by *Electro-Voice, Inc.*, Carrol and Cecil Streets, Buchanan, Michigan.

### HEXACON FLYER

Details on the new *Hexacon* "hatchet type" soldering iron and information on various applications of this tool are included in the single page flyer just released by *Hexacon Electric Company* of New Jersey, for servicemen and manufacturers.

A copy of Form 140 covering this equipment will be sent to those requesting it. Direct your reply to the *Hexacon Electric Company* of Roselle Park, New Jersey.

### MILLEN CATALOGUE

A new component parts catalogue for 1946-47 is currently being distributed by *James Millen Manufacturing Company, Inc.* of Malden, Massachusetts.

Included in this 24-page listing is information on transmitting condensers, dials, drives, scales, knobs, receiving condensers, standoffs, bushings, sockets, r.f. chokes, delay lines, antenna devices, safety terminals, plate caps, binding posts, beads, couplings, coil forms, filters, i.f. transformers and various chassis and other components used by the radio industry.

Both servicemen and manufacturers will find this catalogue of considerable value when ordering component parts.

A copy of this catalogue will be sent to those requesting it from the company, *James Millen Manufacturing Company, Inc.*, 150 Exchange Street, Malden, Massachusetts.

### SERVICING ITEMS

Of interest to radio servicemen, electronic and radio manufacturers and industrial maintenance men is the new catalogue just released by *General Cement Mfg. Co.*

In this 24-page Catalogue No. 147, are listed hundreds of popular servicing items such as radio cements, polishes, varnishes, cleaners, knobs and accessories, phono needles, dial belts, tools, testers, switches and radio hardware.

A copy of Catalogue No. 147 will be forwarded upon request to *General Cement Mfg. Co.*, Rockford, Illinois.

### SPEECH EQUIPMENT

*Collins Radio Company* has just published a new and complete broadcast speech equipment and accessories

**RADIO NEWS**

NOW YOU CAN SEE AND HEAR THE SIGNAL WITH THE NEW  
**CA-12**  
*Signal Tracer*



### \* FEATURING \*

Simplest operation . . . only one connecting cable—NO TUNING CONTROLS! Highly sensitive due to advanced Vacuum-Tube Voltmeter circuit. Tube and resistor capacity network are built into the Detector Probe.

A new Superior Instrument!

Complete with  
Probe, Leads,  
Batteries and  
Instructions.

\$34<sup>85</sup>/<sub>1</sub>

LIBERTY SALES CO., INC.

115 West Broadway, New York 13, N. Y. BRclay 7-6063-4-5



*New Photo  
Electric Unit*

### MODEL A-2

WITH ADDED SENSITIVITY  
For numerous control applications such as burglar alarms, industrial safety controls, automatic counters, or in conjunction with a chime or bell to announce entrance of persons in stores and offices. For A.C. Complete with tubes and built-in SPDT relay..... \$11.95  
LIGHT SOURCE—Will operate up to 25 feet with above unit..... \$5.95  
Write to Dept. EN

**ADSON RADIO CO.**

221 FULTON ST., NEW YORK 7, N. Y.

### Record Breaking Low Price QUALITY RADIO KITS

REDUCED BELOW O.P.A.  
CEILING PRICE



Model S-5P (Illustrated) . . . Improved superheterodyne circuit, built-in loop antenna, PM Alnico Speaker, streamlined airplane dial, wide tuning range, 550Kc-1600 Kc, 5 tubes (including rectifier 115V-AC-DC 12SK7 IF) 12SA7 converter, 12SQ7

Det. and 1st audio 50L6GT output and 35ZGT rectifier, brown bakelite cabinet. Complete kit, less tubes at \$10.95.

Many Other Kit Models Available  
Write for Descriptive Catalog K  
All Kits Furnished Less Wire and Solder  
**RADIO KITS COMPANY**

120 Cedar Street

New York 6, N. Y.



catalogue which should be of interest to the broadcasting industry.

The new catalogue is subdivided to cover speech equipment, remote amplifiers, speech input consoles, mixing panels, program equalizers, console desks, relay panels, turntables and accompanying reproducing group, and various types of monitoring and measuring equipment.

Designed to facilitate the easy selection of equipment, this catalogue includes 40 pages of valuable data. Copies of this catalogue are available from *Collins Radio Company*, Cedar Rapids, Iowa.

**HEAVY DUTY RELAYS**

*Signal Engineering & Mfg. Co.* of New York has just released a four-page data sheet covering their new line of heavy duty multiple arm relays.

Data has been presented covering basic design features, contact ratings, circuit arrangements and other pertinent information.

A copy of Bulletin 30 will be sent to those requesting it from *Signal Engineering & Mfg. Co.*, 150-4 W. 14th Street, New York 11, New York.

**SUPERIOR BULLETIN**

A new catalogue, which replaces all of the previous publications by the company, has just been issued by *The Superior Electric Company* of Bristol, Conn.

Bulletin 150, as the new catalogue is designated, includes charts, circuit diagrams, and other data pertaining to Powerstat variable transformers, SECO automatic voltage regulators and Voltbox a.c. power supplies.

The material is presented in easy-to-read form to facilitate ordering the proper equipment for the job.

In addition to listing the equipment the company has in production, the bulletin offers engineering service on specialized problems faced by the manufacturer.

A copy of Bulletin 150 will be forwarded promptly to those requesting it from *The Superior Electric Company*, 713 Laurel St., Bristol, Conn.

-30-

**Radio Controlled Flight**

*(Continued from page 27)*

with a high-powered v.h.f. radio receiver which can filter out a single channel, or any of the ten audio-frequencies. The v.h.f. transmitter may be located either in a ground installation or a mother aircraft, or, in some installations, both.

Each of the ten audio-frequencies or tones, when filtered, actuates a relay which, in turn, accomplishes a distinct flight function. The drone's mission determines the variety and choice of functions which can be accomplished by radio in any particular set-up.

A control box installed in a jeep, or other ground station, supervises the takeoff of the drone until an airborne mother plane takes over. Either the ground station or the mother plane can control the drone up to a distance of 75 miles. However, effective control varies with the quality of radio reception.

In addition to its radio receiving set, the drone carries two television transmitters. One is trained on the instrument panel and the other on the outside atmosphere. The control pilot can, by flicking a switch, place himself in the position of a pilot in the drone. He can view the area in front of the drone from the "pilot's" seat, or examine the control panel when blind flying is necessary.

The television units in the drone contain an infinity-focus optical system and television camera pickup tube, plus the necessary sweep and electrical circuits for transforming the light waves from the viewed scene into equivalent video signals which modulate the transmitter. A conversion unit generates signals which synchronize the scanning of the mosaic screen with the sweeps of the reproducer tube at the receiver.

The drone's radio receiver actuates the relay mechanism which operates the camera lens stop and optical filter, to prevent "burning" the mosaic, and the optical heating system which prevents fogging.

The transmitter in the drone may

*Olson's 2 Great Money-Savers!*

**OHM CHEST** packed with 100 Insulated Resistors

This handsome Chest has twenty compartments — 10 in the base and 10 in a removable tray. Walnut finish; brass hinges and fastener. Contains 100 resistors stamped with resistance values, 5 ohms to 20 megohms, ½ watt to 2 watts, color coded. Every size is popular. No war surplus resistors in this Ohm Chest!



**\$4.95**

**Free!**

With each Ohm Chest ordered, we send our "Resist-O-Guide" free. Revolving wheels in color show all resistance values.

**CONDENSER KITS**

Sweet savings on seventy 600-V. By-Pass Condensers, made to rigid Olson specifications. Will withstand voltages higher than ratings. Worth much more than our low price! Small size (approx. 1½" long, ½" dia.) makes these units right for compact circuits. Long tinned copper leads. You get 70 Tubulars, as follows:

QUANTITY	CAPACITY
20	.01
10	.02
20	.05
20	.1

**\$4.95**



Send for our Free BARGAIN CATALOGS

**FREE**

**Panel Lamp Tool**

with each Condenser Kit ordered. Rubber tool grips bulb for easy installation or removal in hard-to-get-at positions.



*Paste this Coupon → on a penny postcard and Mail Today to*

**OLSON RADIO WAREHOUSE INC.**

73 E. MILL ST., DEPT. 60, AKRON, OHIO

Send me \_\_\_\_\_ Ohm Chests with 100 Insulated Resistors in each, @ \$4.95. (Resist-O-Guide free with each Chest.)

Send me \_\_\_\_\_ Kits of 70 Condensers each, @ \$4.95. (I will receive a Panel Lamp Tool FREE with each Kit.)

I enclose \$\_\_\_\_\_ Order will be postpaid.

Send my order C. O. D. I will pay postage.

NAME \_\_\_\_\_

ADDRESS \_\_\_\_\_

CITY \_\_\_\_\_

STATE \_\_\_\_\_



**JOBBER-SHOP WHOLESALE**

**QUANTITY-BUYERS!**

**MID-AMERICA'S  
UNBEATABLE  
LOW PRICES  
DOUBLE Your Profits!**

**WHOLESALE ONLY!**

Quantity buyers! MID-AMERICA has 70,000 square feet of warehouse space jam-packed with radio parts, electronic equipment, etc. Items at UNBELIEVABLY LOW PRICES—that will save and make you money. Listed below are a few samples!



**Universal Output Transformer**  
will match voice coil to any tube, single or push-pull. Strap mounting on 2 1/4" centers. Size: 2 1/4" high, 2" wide, 2" deep.  
Minimum order—100 each **98c**

**AC-DC CHOKE** 15 henry, 50 MA, 120 ohms DC resistance. Size: 1 1/4" x 2" x 1 1/2"  
Minimum order—50 each **59c ea.**

**ACORN TUBE SOCKET** Low loss ceramic socket with rugged spring contacts for 954 and 955 tubes  
Minimum order—100 **\$750 Per 100**



**SPEAKERS**

5" Alnico V PM Speaker with 4 ohm voice coil, less output transformer. Minimum order—100 **\$1.37 ea.**

6" Alnico V PM Speaker with 2.15 Alnico V slug. Minimum order, 100 **\$1.79 ea.**

**PL-68 PLUG Jack Set** with 4 ft. of 3-covered cable with PL-68 plug on one end and 3-way open circuit jack, at other end. Minimum order—100 each **15c**

**10 Watt RESISTORS** any ohmage—per size or assorted  
Minimum order—100 **\$7.00 per 100**

**GUARANTEED**

All items shown in this ad are guaranteed as rated by nationally-advertised manufacturers and are new, unused and in perfect condition.



**Milliammeters—GE & Westinghouse**

0-300 MA DC, 2 1/4" flange, 2 1/4" dia. body, 1 1/2" deep. **\$1.95**  
0-20 MA DC, 2 1/4" flange, 2 1/4" dia. body, 1 1/2" deep. Both types with white scale, black markings. (Minimum order each type—10.)

**RELAYS**—Write for 12-page book illustrating more than 250,000 relays. 24c each, and up.

**APC CONDENSERS**—8c each, and up! We have large quantities of unused APC condensers—all at ridiculously low prices! Ask for special condenser listing!

**FREE CATALOG**

**TERMS:** We extend usual credit to rated accounts. Others send 25% with order, balance C.O.D. All prices shown are f.o.b. Chicago warehouse.



Mail orders and catalog requests to store address—Dept. E-17

You ain't seen nothin' yet! Rush firm name and address for MID-AMERICA'S big catalog listing hundreds and hundreds of hard-to-get radio parts, transmitters, etc.—ALL AT UNBEATABLE LOW PRICES!

**MID-AMERICA CO. Inc.**

STORE: 2412 S. MICHIGAN AVE. CHICAGO 16, ILL.  
WAREHOUSE: 2307 S. ARCHER AVE. CHICAGO 16, ILL.



"Mother" plane hovers near her drone. In foreground a jeep control station is about to "take over" the operation of landing the drone.

be adjusted to operate on any one of the ten separate frequency channels between 264 and 372 mc. This permits the simultaneous operation of ten separate sets within the general area without interference. However, a different antenna unit is required for each of the ten operating frequencies.

The FM radio control receiving equipment on the drone permits ground-to-air or air-to-air control up to a normal range of 18 miles. However, by the use of an r.f. amplifier unit the effective range may be stepped up to 75 miles. The receiver-selector incorporates an eight channel audio filter selector circuit for discrimination between the various tones received. A relay unit passes control voltages to the automatic pilot from the receiver output.

Normally, the altitude of the drone is automatically controlled by altimeter

equipment installed for that purpose. However, the altimeter setting may be overridden, when necessary, by a special relay box.

The television receiving and reproducing system employed in the mother aircraft is a superheterodyne type receiver which amplifies the received signal and removes the video component from the carrier. It impresses this video signal on the grid of the picture reproducing tube, which in turn reproduces the scene viewed by the drone camera equipment.

This unit also generates the necessary horizontal and vertical deflection voltages for the cathode-ray picture reproducer tube. The scanning of the picture pickup mosaic screen on the drone, and the generating of sweep circuits for the picture reproducer tube on the mother plane, are synchronized by special pulses generated by the drone transmitter.

Closeup of jeep control station showing the control box in the foreground.

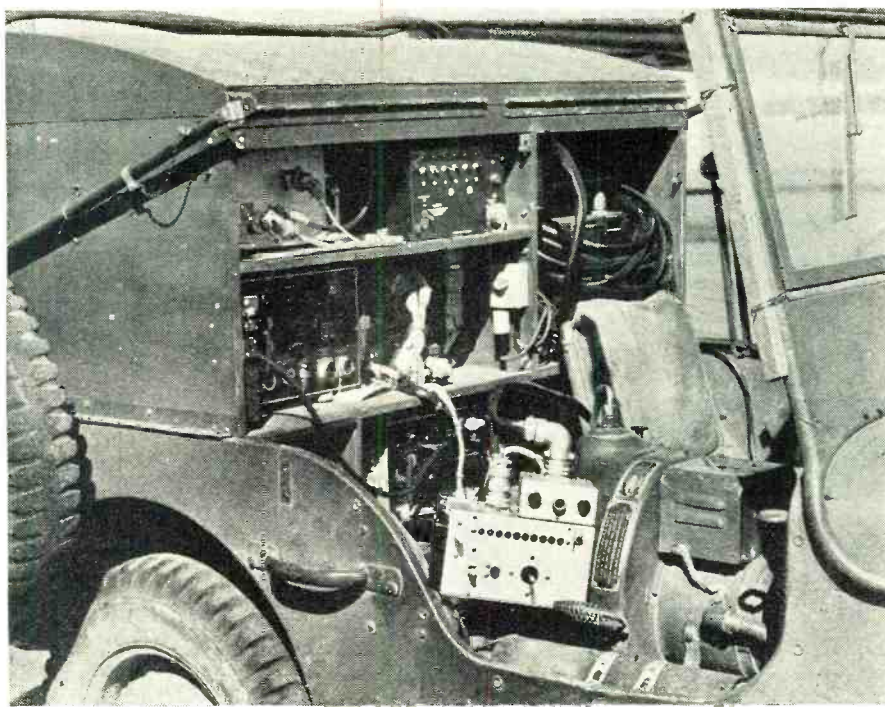



Ten different antenna units are supplied with each receiving set. They operate at spot frequencies within the frequency bank of 264 to 372 mc., and are located approximately 12 mc. apart. The antenna is gyro stabilized within the aircraft.

Operational and tactical use of the drone and other guided missiles is being subjected to a thorough evaluation by a group of highly-qualified specialists under the direction of Colonel Harvey T. Alness, commanding officer of the Army Air Forces 1st Experimental Guided Missiles Group at Eglin Field, Florida. It is his duty to subject to punishing tests new projects in the remote control field development of AAF engineers.

The following radio control and television equipment was used in the flight from Hawaii to the United States in *Operation Remote*:

- a. Installed in drone aircraft:
  - (1) AN/ARW-1 Radio Control Receiver
  - (2) AN/AXT-3 Television Transmitter
- b. Installed in mother aircraft:
  - (1) AN/ARW-18 Radio Control Transmitter
  - (2) AN/AXR-1 Television Receiver

The AN/AXT-3 differs from AN/AXT-2 in that it contains an additional optical system and conversion unit for televising flight panel data. All AN/AXT-3 sets were created through modification of AN/AXT-2 sets.

-30-

The U.S. Army metascope, used to detect the presence of infrared light. Small enough to be held in one hand, this instrument was used by paratroopers to detect the infrared radiation which signaled landing spots. A small lead-sheathed compartment in the base of the metascope, containing radioactive material, furnishes the power source for the device. When a control switch on the outer hull of the unit is set on "charge," energy from the radioactive material is used to charge a viewing screen which is thus made sensitive to infrared radiation. A periscope-like mirror with an infrared filter, located in the cover of the unit, is raised to pick up the infrared light.



# Prepare NOW for a Better Job in RADIO ENGINEERING



**Don't Delay—Write Today!**

## ADD TECHNICAL TRAINING TO YOUR PRACTICAL EXPERIENCE

Cleveland Institute Courses Offer Complete TECHNICAL TRAINING Ranging From Low-Level to College-Level

- A. **Master Course in Radio Communication.**  
Covers fundamentals of Radio and includes complete preparation for FCC Commercial License Examinations.
- B. **Advanced Course in Radio Communication Engineering.**  
A college-level Radio Engineering Course.
- C. **Specialized Television Engineering.**  
Including post-war Television Techniques.

### All Courses Include

The Remarkable Workbooks of Instructional Aids, prepared by the instructing staff of Cleveland Institute.

Choose the course best suited to your needs—Start with the section you are qualified to enter—Use the economical CIRE "Pay-As-You-Go Plan."

You may enroll for individual sections for highly specialized training. Study any one or more of the following sections if you do not require a complete course—

- 1. Mathematics of Radio
- 2. Fundamentals of DC and AC Theory.
- 3. Essentials of Radio Communication.
- 4. Communication Networks.
- 5. Advanced Radio Telephony for the Broadcast Operator.
- 6. Audio and Radio Components and Systems (Design of Receiver and Transmitter Equipment).

Write for descriptive folder.

## CLEVELAND INSTITUTE OF RADIO ELECTRONICS

Contractors to the Canadian Broadcasting Corporation

Successors to

NILSON RADIO SCHOOL  
Founded 1939

SMITH PRACTICAL RADIO INSTITUTE  
Founded 1934

RN-1 TERMINAL TOWER, CLEVELAND 13, OHIO

Approved for Veteran Training Under "G-I Bill of Rights"

### (MAIL THIS COUPON)

Cleveland Institute of Radio Electronics, RN-1 Terminal Tower, Cleveland 13, Ohio.  
Gentlemen: Please send information about your home study courses in Radio Electronics.

NAME..... I desire training in.....  
 ADDRESS..... I have had experience in broadcasting   
 CITY..... servicing  operating  mfg.  CAA   
 ZONE..... STATE..... Army-Navy  amateur  other.....  
 I am a High School Grad.  College   
 Degree.....  Check here for Veteran Enrollment Information

### S/C LABS ADJUSTABLE ROTARY BEAM KITS 702A, 702B, 702C,

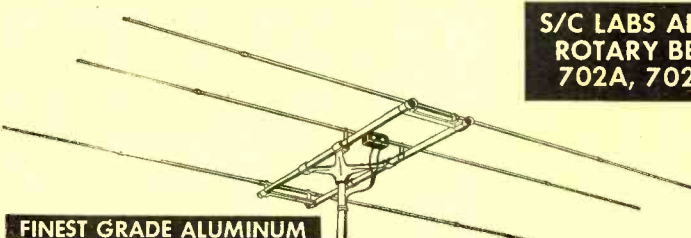

#### FINEST GRADE ALUMINUM

- Type 702A 28.1 mc to 29.7 mc (10 meter band).....\$44.95
- Type 702B 50 mc to 54 mc (6 meter band)..... 29.95
- Type 702C 144 mc to 148 mc (2 meter band)..... 24.50

The new S/C LABS THREE ELEMENT BEAM presents a distinct high-gain directive antenna designed for 2, 6, and 10 meter amateur bands, adjustable in every respect and sound in mechanical design. Electrically and mechanically engineered to give the best in efficiency. Weight of entire beam is less than 15 lbs.

PRECISION AND ADJUSTABLE ANTENNA  
 Type 701A (28-44 mc) 10-meter amateur.....\$6.50  
 Type 701B (44-58 mc) Television 5 meter amateur 5.85  
 Type 701C (88-148 mc) FM 2 meter amateur..... 5.75  
 In stock, all types of coaxial cables, transmission lines and hookup wire.  
 See your local dealer or send for circular.

S/C LABORATORIES, INC., DEPT. R, 20 VAN WAGENEN ST., NEWARK 4, N. J.



# • • • Beyond Your Imagination



**In Postwar Design**  
Model 200 Power Supply only 4" x 4" x 2", delivers 250 volts D.C. at 100 Ma. From 117 volt A.C. source fits in the palm of your hands, weighs only 1 lb. 8 oz. Rectifiers last indefinitely!

UNIT PRICE **\$9.95**



**Code Oscillator**  
Model 205 Code Oscillator chassis only 4" x 4" x 2" variable tone, can be used with any number of keys, phones and speaker. 110 volts AC-DC. Supplied complete with tube.

UNIT PRICE **\$9.95**

LITERATURE AVAILABLE — SEND DEPOSIT WITH ORDER — DEPARTMENT N

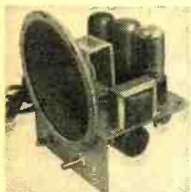

**No. 30—Three Tube Phono Amplifier Kit** as shown with 3" PM speaker. You get all parts and instructions. Operates on 115 V. A.C.-D.C. Uses 12SQ7, 50L6, 3S25 tubes.

Kit Complete **\$4.95**

Chassis only **\$0.59**



**Model 80 Phono Amplifier** A.C. only delivers 4 watts output. Tone and volume control. Wired and tested complete with 6J5, 6V6 and 80 type tubes.

UNIT PRICE **\$10.50**

## SOUND PRODUCTS COMPANY

80 Main Street

WHITE PLAINS, N. Y.

NOW YOU CAN SEE AND HEAR THE SIGNAL WITH THE NEW

# CA-12 Signal Tracer

★ **FEATURING** ★

Simplest operation . . . only one connecting cable — **NO TUNING CONTROLS!** Highly sensitive due to advanced Vacuum-Tube Voltmeter circuit. Tube and resistor capacity network are built into the Detector Probe.

A new Superior Instrument!

Complete with Probe, Leads, Batteries and Instructions. **\$34.85**

**GENERAL ELECTRONIC DISTRIBUTING CO.** • 98 Park Place • New York 7, N. Y.

Send for FREE catalog of Testing Equipment

**NOW!**  
4-in-1 offers  
**JOB CARD STYLING**

"CUSTOM TAILORED" SERVICE RECORDS STYLED TO ORDER

SAMPLES AND PRICES ON REQUEST

**Radio Press** MORGANTOWN WEST VIRGINIA

### BARGAINS

2" PM Speaker with Output	\$ 1.58
Lapel Mike Cable . . . . .	.066 ft.
Generator Condensers	\$ .24
Solar .1—25 or .5 MFD . . . . .	
Solar 30 MFD 450 Can. . . . .	
Plugs into Octal Socket . . . . .	\$ .78
Signal Generator—All Wave . . . . .	\$49.95
Tube Checker—Latest Portable . . . . .	\$39.50
Table Radio Phono. Cabinet Blank . . . . .	\$ 9.95
Superior CA-11 Signal Tracer . . . . .	\$18.75
Record Changer . . . . .	\$18.95 ea.—2 for \$35.00

Send For Latest Bulletin

**MAC'S RADIO SUPPLY**  
8320-22 LONG BEACH BLVD.  
SOUTH GATE, CALIF.  
Telephones — KIMBALL 4111 - 4112

## International Short-Wave

(Continued from page 128)

in Eastern U.S. A Chinese station heard mornings on the West Coast on approximately 6.050 may be one of the new Nanking transmitters. (Dilg)

XTPA, 11.650, Canton, is coming through again early mornings to the East; appears to use only Chinese in programs, but does announce call in English at times.

Since China has gone back to standard time, XNCR, 7.520, Yenan, is scheduled 7-8:30 a.m.

XORA, 11.695 (varying), Shanghai, has poor signal on West Coast this winter. (Dilg) Was fair to good early mornings here in West Virginia during later summer and early autumn, but has been inaudible lately.

CZECHOSLOVAKIA — Prague's OLR4A, 11.84, is being heard opening at 3 p.m. daily; starts English program at 3:30 p.m., with the news being read at 3:45 p.m.; appears to use French at 4 p.m., Spanish at 4:30 p.m.; uses Dutch later on and usually identifies in German around 5:30 p.m.; the National Anthem ("Kde Domov Muj") follows and the carrier leaves the air at approximately 5:35 p.m. (Havlena) Sends fair to good signal here in West Virginia.

In the nightly North American beam, 7-7:30 p.m., OLR5A, 15.230, has a fair to strong signal; English news is heard most evenings, around 7:07 p.m. (Casey) I note that more fluent English is being broadcast.

DENMARK—OZF, 9.520, Copenhagen, is scheduled 12:30-5:30 p.m.; OZH, 15.320, is heard on same schedule, but Sundays only no English. (Friis) The new 50-kw. short-wave station is to commence operations early in 1947. (Cushen)

DOMINICAN REPUBLIC—Glyn Moss, Ontario, sends along this information secured direct from a friend employed at HI9T. This station is located in Puerto Plata and is called "Broadcasting Tropical"; operates daily, 10 a.m.-2 p.m. and 4-7 p.m., except on Thursdays when the evening transmission runs to 9 p.m. Frequency is 6.175.

ENGLAND—Latest official listings of the BBC's North American Service are: GWH, 11.80, 5-6 a.m.; GSP, 15.31, 6-8:15 a.m.; GRP, 18.13, 8-11:15 a.m.; GRP, 18.13, 11:30 a.m.-4:15 p.m.; GSP, 15.31, 4:15-7:45 p.m.; GWH, 11.80, 4:15-9:45 p.m.; GSC, 9.58, 4:15-11 p.m.; GRH, 9.825, 5-11 p.m.; and GSL, 6.11, 7-11 p.m.

GSK, 26.100, is reported to be carrying the African Service, afternoons.

European Service of the BBC is still being heard in the United States afternoons and after midnight on such frequencies as 7.120, 7.230, 7.260, 7.320.

FINLAND—From this country English news is being heard nightly at 7:25 p.m.; has Finnish between 7:35-7:45 p.m. sign-off; is heard in East on OIX4, 15.190, but woman announcer says OIX2, 9.505, is also being used at



the time of this beam to America.

FRANCE—Recently, *Radio Paris* was heard on 9.94 in the evening North American beam, beginning at 9 p.m. with *English* news, but at last report was back on 9.550; 11.845 is in parallel and is the better signal. (Balbi) Appears to have dropped the 10:30 p.m. *English* news repeat. (Cooper)

FRENCH INDO-CHINA—*Radio Saigon's* evening transmission on 11.778 is now heard 6-7:15 p.m. (Balbi) I believe this is entirely in French. A good signal is heard from this station at 5-5:30 a.m. when *English* news is given. According to Swedish observers, the 4.810 transmitter is heard there well at 5:30-6 a.m.

Rex Gillett, Australia, reports that after a short period on about 9.580, Hanoi is again being heard back on 9.600; at the conclusion of *English* news about 6:15 a.m., the station announces, "You have just been listening to the day's news broadcast from Hanoi, Indo-China." Later in the day, Hanoi is heard in Australia on 11.900; modulation of both outlets is always poor.

FRENCH WEST AFRICA—*Radio Dakar*, FHE3, heard signing on at 1:45 p.m., usually is blocked out by WLWS, 11.710, when latter takes to the air at 2:15 p.m. (Harris)

GERMANY—Leipzig, 9.680 (listed as 9.688), "*Mitteldeutscher Rundfunk*," is heard in Denmark with a powerful signal, 8 a.m.-2 p.m. and between 4-6 p.m. (Friis) "*Berliner Rundfunk*,"

6.072, has *German* news between 11:45 p.m.-12:10 a.m.

DTCY, the 100-kw. American short-wave station in Munich, 5.3025, is still testing each Monday, Wednesday, Friday at 9-9:30 a.m.; address, The Military Government Station DTCY, A.P.O. No. 170. (Skoog)

BFN, 7.290, Hamburg, carries same program as AFN, 6.078, Saturdays, 6-7:20 p.m.; should not be confused; BFN often relays BBC's GFP. (Harrison) In British Columbia, is heard opening at 1 a.m., relays BBC's "7 o'clock news" at 2 a.m.; good signal. (Cooper)

GOLD COAST—ZOY, announcing as on 61.04 meters (probably is 4.915), Accra, is heard in South Africa daily from 12 noon to 1:30 p.m.; relays BBC news from London at 1 p.m., followed by local news and schedules. (BSWL)

GADELOUPE—"Radio Guadeloupe," 5.985 (varying), was recently picked up at 7:35 p.m., still going at 8:05 p.m. (Bromley)

GUAM—According to Australian and New Zealand sources, it is probable that WXLI, "*Radio Barrigada*," 1380 kcs., using 325 watts at present, will add short-wave facilities, in addition to becoming the main U.S. outlet in the Western Pacific area.

GUATEMALA—TGWA, 15.170, has fine signal now, evenings. (Harris)

HOLLAND—PCJ, 15.220, Hilversum, appears to have daily morning broadcast beginning at 8 a.m. (Grivakis) This is probably beamed to Nether-

lands East Indies. *PCJ* will celebrate its 20th anniversary this year.

HONG KONG—According to a recent DX broadcast from *Radio Australia*, ZBW is now operating on 9.540; West Coast monitors report the frequency rather as about 9.538; poor signals are heard some mornings here in the East, around 6:30-6:45 a.m.

INDIA—VUD7, 6.19, Delhi, now signs on at 10 a.m., is audible on West Coast to around 11 a.m. (Balbi) The 15.16 frequency is heard well both East and West Coasts mornings; some days has surprisingly good signal here in West Virginia at late as the 9:30 a.m. *English* news period. The 8:30 a.m. *English* news is heard well some mornings on 11.850.

Calcutta's 7.21 is used in parallel with Delhi's 15.16, 11.87, and 9.59, mornings; *English* news is at 7:30 a.m. Madras, on 7.255 (listed), also carries this 7:30 a.m. news. (Balbi) Calcutta goes down to the 3-megacycle band at 8 a.m. (Dilg)

Bombay is using 7.24 mornings instead of 9.63; carries *English* news at 7:30 a.m.; moves to 4.880 at 9:15 a.m. (Dilg)

IRAN—*Radio Teheran*, EPB, 15.100, can be heard some mornings in the eastern U.S. around 6:15 a.m. when it has *English* news; identifies in French at 7 p.m. as "Ici Teheran," then continues with French news; I recently heard the station leave the air abruptly at 7:30 a.m.

Swedish observers report EPQ, 6.155

## Model 2450 ELECTRONIC TESTER

★  
There's never been a tester like this!

Here's a tester with dual voltage regulation of the power supply DC output (positive and negative), with line variation from 90 to 130 Volts. That means calibration that stays "on the nose"! That means broader service from a tester that looks as good as the vastly improved service it provides. This model includes our Hi-Precision Resistor which outmodes older types.

HIGHLIGHTS—42 ranges: DC and AC. Volts: 0-2.5-10-50-250-500-1000 • DC MILLIAMPS: 0-0.1-1.0-10-50-250-1000 • OHMS: 0-1000-10,000-100,000 • MEGOHMS: 0-1-10-100-1000 • CAPACITY IN MFD: 0-.005-.05-.5-5-50 • LOAD IMPEDANCE: 51 megohms on DC Volts • CIRCUIT LOADING: Low frequencies. Circuit loading equal to 8 megohms shunted by 35 mmfd. High frequency circuit loading equal to 8 megohms shunted by 5 mmfd.

Detailed catalog sheets on request.

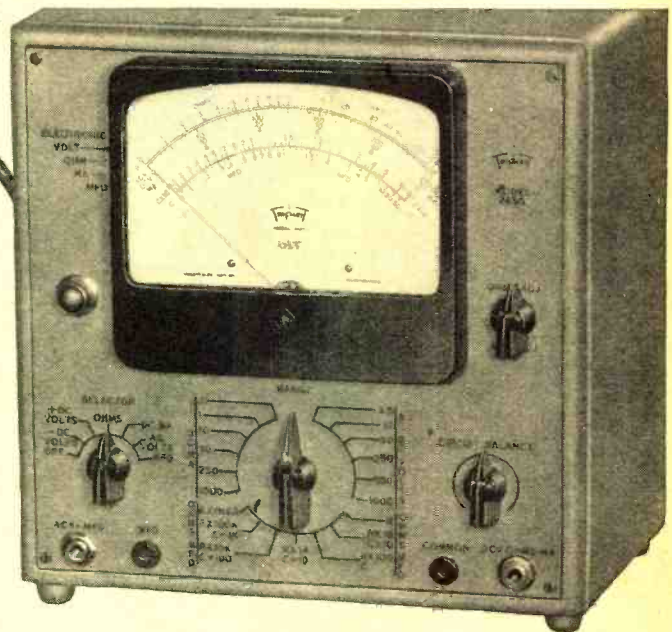

Precision first  
...to last

# Triplet

ELECTRICAL INSTRUMENT CO. BLUFFTON, OHIO





# BUYERS SYNDICATE Presents

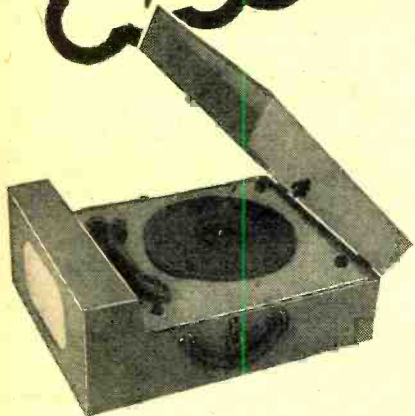

## PHONO-KIT

PORTABLE ELECTRIC PHONOGRAPH KIT

A REAL QUALITY 110V AC PHONOGRAPH KIT  
CONSISTING OF THE FOLLOWING PARTS

- Handsome leatherette portable case
- High quality motor with 9" turntable
- Light weight crystal pickup
- 5" Alinco speaker with transformer
- Tone tested 2 tube amplifier with tubes
- Tone control and needle cup
- Nothing else to buy. Only 1 hour to assemble for play. Full instructions supplied.

SPECIAL YOUR COST ..... **\$21.50**

LOTS OF TWO OR MORE ..... **\$19.95**

### OTHER BUYERS SPECIALS

- 2 Tube Amplifiers, tone and volume controls and tubes. Your cost 4.45
- 3 Tube Phono Amplifier including tubes, tone and volume controls. High quality parts. Ready to play. Your cost 5.25
- Phono Oscillator with 2 tubes, tested and ready to play. Your cost 5.25
- Speakers 5" P.M. Alinco magnet. Your cost 1.65
- Speakers 6" P.M. Alinco magnet. Your cost 1.85
- Output Transformers for 50L6 tubes. Your Cost .59
- Output Transformers for Push Pull 50L6 Your cost .79
- Standard 4 Prong Vibrators made by Mallory. Used on most auto sets. Your cost 1.40
- 2 volt, 7 Prong Vibrators for G.E. and other portable sets. Your cost 1.50
- Acorn Tubes Type 955. Your cost .60
- Microampmeters 0-500, 2" round. Famous brands. While they last. Your cost 3.25

### WRITE FOR BARGAIN CATALOG

20% deposit with order. Balance C. O. D.  
All materials sold on money back guarantee

## BUYERS SYNDICATE

786 CAREW STREET, SPRINGFIELD, MASS.

(varying), is heard there around 11 a.m.

**IRELAND**—Bertram Podall, Vermont, writes that in April of last year, following directions given on a broadcast of *Radio Eireann*, he wrote to the Consulate General of Ireland, Chrysler Building, New York City 17, and received a letter from that office stating that his report was being forwarded to Dublin and that he would hear from there. In two months he did receive a letter thanking him for his report "and to confirm your reception of the 4th of April." The verie came from Office of the Engineer-in-Chief, Department of Posts and Telegraphs, The Castle, Dublin.

**ITALY**—*Radio Italiana*, 9.630, Milan, is being heard in Denmark, 1-6 p.m. (Friis) Comes in to West Coast well by 5 p.m.; has bird identification; Italian news is at 6 p.m., just prior to closedown; has occasional identification in *English*. (Cooper) Is heard on 11.810 afternoons in East, has *English* period between 1:20-2:10 p.m.; announces 9.630 as in parallel. (Grivakis)

**JAPAN**—JLP, 9.605, Armed Forces Network, Tokyo, off since November 1. (Bilbi) I recently heard JVU2, 11.845, Tokyo, in contact with San Francisco between 7-8 a.m., excellent signal.

The Home Service from Tokyo is heard early mornings "back at the old stand" on 7.258, 7.285, 9.560, 9.505, 4.930, 4.910, and others. (Dilg)

**JAVA**—Rex Gillett, Australia, reports that a recent letter received from Lieut. W. Werner, formerly of *Radio Balikpapan*, Dutch Borneo, stated that a new 100-kw. transmitter has arrived in Java from the United States and that a suitable site in either Batavia or Bandoeng was being

sought. Whether this is for short-wave or BCB use was not indicated.

*The Indonesian* operating on approximately 12,002 was heard by Australians to announce location as Djokjakarta; was heard at 5 a.m.; signals in Australia are only fair; is heard in certain parts of the U.S. also, particularly in the Deep South.

From South Africa, Mervyn Laubscher reports the Indonesian on 8,000 is heard as early as 8:30 a.m. with weak signal; at 9:30 a.m. announces program for Dutch Forces and has requests until 11:30 a.m.; announcements are mostly in Dutch, but at 11:30 a.m. sign-off a man announces in *English*, "This is the Official Dutch Station in Bandoeng"; further *English* announcements are quite irregular, sometimes they announce frequencies but usually just say that they're signing off and wish everybody "Goodnight." Time in Bandoeng at 11:30 a.m. EST is given as "midnight." Announced wavelengths of 99.5 and 37.5 meters (3,015 and 8,000, respectively).

**LUXEMBOURG**—*Radio Luxembourg*, 6.092, is heard with an *English* session between 3-3:30 p.m. (Milne)

**MADAGASCAR**—*Radio Tananarive*, 6.138 and 6.063, is heard on West Coast most mornings; at times, however, only the 6.063 transmitter is audible. (Dilg)

**MALAYA**—Singapore's 15.275 is heard well early mornings in Colorado. (Woolley) The 15.300, 15.275, 11.735, and 6.77 frequencies open now at 3:45 a.m.; *English* periods are at 3:45, 6:30, 7:30, and 9 a.m.; oriental type sessions are broadcast during the intervening times; the station closes down at 9:30 a.m. (Gillett, RADIO CALL) "The Voice of Britain" period

Kenneth C. Prince, manager of the 1947 Radio Parts & Electronic Equipment Show (left) and Jack Berman, of Shure Brothers, Show president, inspect a floor plan of the exhibit hall at the Stevens Hotel in Chicago where record crowds are expected to assemble to view new radio components. Peggy Skeffington of the Show staff explains display arrangements. Drawing for exhibition space took place in N. Y.

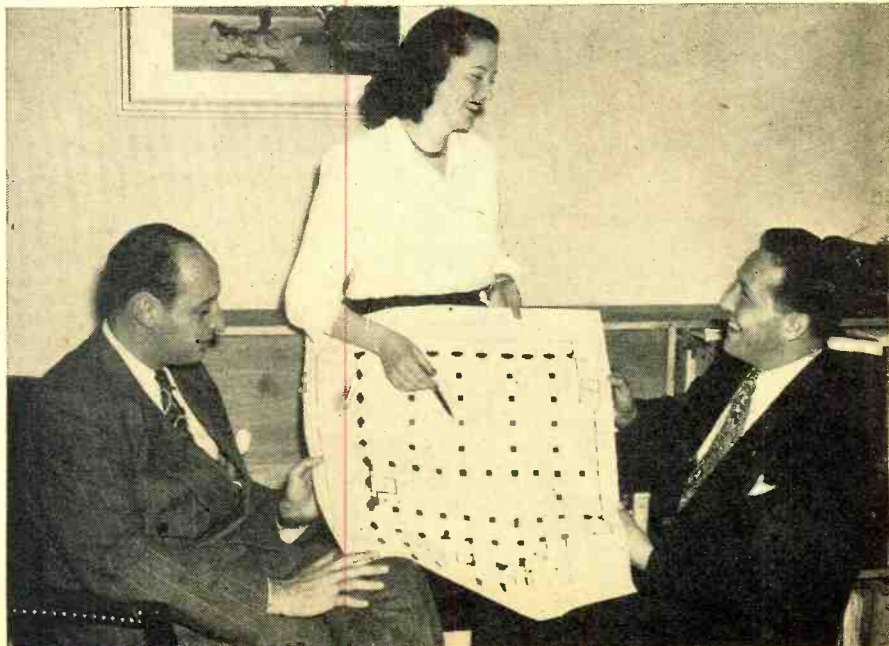



appears to be scheduled for 8:30 a.m.

**MANCHURIA**—August Balbi, California, reports a station on 11.77, heard from 5 a.m., that may be MTCY, Changchun (Hsinking), listed on 11.775 with 20,000 watts. Manchukuo has been heard mentioned many times.

Australians report a station tuned on 7.275 at 8:30 a.m. with a news service in a Chinese dialect may be located in this country; such cities as Harbin and Hsinking are mentioned frequently; music is broadcast prior to 8:30 a.m. (Gillett)

**MAURITIUS**—Reports from several quarters that a s.w. station is operating from this island on the 41-meter band have not been confirmed. A careful check by Mervyn Laubscher, Johannesburg, South Africa, at my request, did not reveal a station operating from Mauritius. Mr. Laubscher reports, however, that his failure to pick up the station may have been because of bad static interference on that band; he will check further. It is possible the station reported was an amateur.

**MONACO**—Radio Monte-Carlo, 6.130, heard signing on at 1:30 a.m. with musical selection; then woman announces, "Ici Radio Monte-Carlo"; musical program follows. (Sutton) Is heard in England at 3:30-4:30 p.m.; badly QRM'd; uses single gong; woman announcer; French only; frequency appears to be higher than listed, probably about 6.135/40. (Harrison)

In a verification letter to a Scandinavian correspondent, Karl-Ake Bergstrom, Radio Monte-Carlo officials wrote: "We do not own our complete equipment yet, but we hope that the final installation will take place in 1947. Our transmissions are probably not heard very well at present because we have only one long-wave transmitter of 10 kw. on 410 meters and one experimental short-wave station of 300 watts on 48.95 meters. Our transmissions take place each day at 1:30-3:30 a.m., 6-8 a.m., and 1-5:15 p.m. We hope to be in a position to give better service starting in 1947 when our complete installation will be finished. We will have a short-wave outlet of 25 kw. at the beginning of 1947 and our long-wave station will run with 120 kw., probably around July, 1947." A descriptive booklet on the Principality of Monaco was enclosed. The address is Administration-Direction, 16, Bd. Princesse Charlotte, Monte Carlo, Monaco.

**MOZAMBIQUE**—A station heard Sundays opening at 10 a.m. on approximately 4.910 is believed to be Mozambique; weak signal, but should improve during winter months. (Dilg)

**NEW CALEDONIA**—Radio Noumea, 6.210 (listed as 6.208), now gives power as 500 watts. (Gray) Operates around 2-4 or 5 a.m.

**NEWFOUNDLAND**—VONH, 5.970, St. John's, is heard well at 8 p.m. in English newscast.

**NEW ZEALAND**—ZLT7, 6.715, Wellington, appears to have left the air, possibly in preparation for advent of the long-promised new s.w. transmitter.

January, 1947



# "COME AND GET IT! SAVE REAL DOUGH IN THIS TRADE-IN SALE OF TEST EQUIPMENT & RECEIVERS"

"Here's the deal, fellows . . . if you have something to trade, send us your old instrument by prepaid express. Notify us which new instrument you are interested in. We'll quote you our best deal. You are under no obligation for an appraisal. References: Dun & Bradstreet, United Bank and Trust Co. of St. Louis."

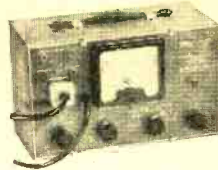

## "YOU GET A HUGE ALLOWANCE ON A VOMAX"

Trade in the old—get a new "Vomax," one of the finest test instruments of its type! Send in your old instrument today and we'll make you a real allowance toward this outstanding VTVM even though its regular price is still only . . . **\$59.85**  
Less A Terrific Trade-In Allowance

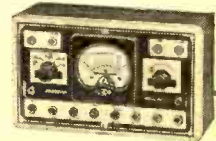

## "BIG TRADE ON RADIO CITY MULTITESTER"

Model 447. DC Volts: 0-5-50-500-2500. AC and Output Volts: 0-10-100-500-1000. D C M A : 0-1-10-100-1000. Ohmmeter: 0-500-100,000 ohms. 1 megohm. Db. Meter: minus 8 to plus 50 db. Res. price . . . **\$17.95**  
Less Trade-in Allowance



## "A REAL DEAL ON HICKOK 532P TUBE TESTER"

The original Dynamic Mutual Conductance Tube Tester, standard for Laboratories, Tube manufacturers and set manufacturers. Reg. price (big trade-in still to be deducted) . . . **\$121.20**

Thordarson Smoothing Choke, 200 Millis, 12 Hly. 2 mfd. 150V Condensers. . . **\$3.50**

**Ballentine Phono Motor**  
With turntable. A quality, velvet-smooth precision motor . . . **\$4.44**

## "UP TO \$150.00 ALLOWANCE ON AN RME 45"

Your Ham receiver may be worth up to \$150.00 in trade on this outstanding new receiver. Send your set in or write us what you have. We'll reply right away with a deal to good to pass up!



**\$198.70**

## "PLENTY OF REAL BARGAINS, FELLOWS!"

Hammarlund-type APC Padder Condensers, 25, 35, 50, 100 and 140 mmfd., your choice, each . . . **34c**  
Navy Gray ALUMINUM HORNS with 15 watt driver unit, while they last for only . . . **\$17.50**

AMPLIFIER CHASSIS with covers. De Luxe style, chrome trim, gray enamel.			
Number	Size	Reg. Price	Sale Price
3973	7 x 17 x 9	\$4.95	\$3.72
3974	10 x 14 x 9	5.40	4.05
3975	10 x 17 x 9	5.70	4.28
AMPLIFIER CHASSIS with cover. Standard style, gray enamel.			
3983	10 x 14 x 9	\$3.51	\$2.64

W0ULH W0IYD W0P6I W0GTF W0LDO W0ZIP

Write for Free Catalog

*Walter Ashe*  
**RADIO CO.**  
1125 PINE ST. ST. LOUIS, MO.

## CAREERS in RADIO

**INTENSIVE COURSES**—Thorough, technical education for progressive men and women.

Licensed by the State of New York

- 1. RADIO TECHNICIAN**—The MRI General Course. Includes F.M. & Television. Prepares for FCC Broadcast Licenses.
- 2. RADIO & TELEVISION SERVICING**—Prepares for employment as Repairman on Standard Broadcast, F.M. & Television Receivers.
- 3. RADIO COMMUNICATIONS**—Prepares for FCC Operators' License. Leads to position as Merchant Marine or Flight Radio Officer; Commercial Operator.
- 4. FUNDAMENTAL RADIO MATHEMATICS**—The MRI Preparatory Course. Required pre-training for students lacking a basic mathematical background.

**MELVILLE RADIO INSTITUTE**  
45 W. 45th St., N. Y. 19, BR 9-5080  
"The Radio School Managed By Radio Men"

**MELVILLE RADIO INSTITUTE**  
45 West 45th St., New York 19, N. Y.

GENTLEMEN:  
Send me FREE information about your school. RN

Name.....  
Address.....

MAIL THIS COUPON NOW



# The LANE RECORDER

Now available for  
**IMMEDIATE DELIVERY!!**



Here's the 78 r.p.m. Recorder and Phono-Combination You've Been Waiting For!!!

- \* **HIGH FIDELITY AMPLIFIER.** Flat from 30 to 15,000 cycles.  $\pm 2$  db. Amplifier uses push-pull output, phase inverter, inverse feedback.
- \* **BUILT TO LAST.** High quality components throughout.
- \* **GENERAL INDUSTRIES MOTOR AND RECORDING UNIT. JENSEN SPEAKER.**
- \* **LIGHTWEIGHT PLAY-BACK PICKUP.**

Technical know-how, skill in construction, and the use of **ONLY HIGH QUALITY PARTS**, result in a unit that not only sounds good, and looks good, but is also built to last . . . to give performance and service for years.

**MAGNIFICENT TONE QUALITY!!** Why? Because the LANE uses a high fidelity circuit, push-pull output, phase inverter, and inverse feedback. Flat from 30 to 15,000 cycles.

The LANE phase inverter circuit is **ALWAYS IN BALANCE**, even after the tubes grow older—a patented feature. The LANE also incorporates an excellent form of inverse feedback that works beautifully.

**LOOKS GOOD!!!** The LANE is built into a luxurious portable case. Well built—with extra re-inforcement, leather carrying handle. Also has a handy compartment for carrying mike and cable.

**BUILT TO LAST!!!** Here's a feature that's extremely important. We use only high quality parts in all LANE equipment. All condensers have a **100 to 300% SAFETY FACTOR**. This means that condensers, in addition to being the best available, are rated at voltages considerably higher than actually needed. Resistors too, and other parts, are the finest available. The AC DC circuit combines simplicity with extreme durability and efficiency. Components run cool.

Cuts up to 12" discs.

Tube line-up: 6SJ7, 6SC7, two 25L6's in PP and 25Z6 rectifier. AC motor. Phono has output of 5 watts. All our products are guaranteed.

**SEND FOR YOURS TODAY!!!**

Price  
f.o.b. N. Y. **\$119.50**

Astatic JT 30 crystal microphone, price, \$10.50

We also have available for immediate delivery the Burkaw home recorder. (78 RPM, AC DC single ended amplifier, AC motor, freq. response approx. 50 to 8000 cycles.) Price (including crystal **\$97.50** mike)

Terms: 25% deposit, balance C.O.D.

**NEW YORK RADIO COMPANY**  
83 AMSTERDAM AVENUE  
NEW YORK 23, N. Y.

ters from this country. Watch for the new ones early this year; listed assignments include ZL1, 6.080; ZL2, 9.540; ZL3, 11.780; ZL4, 15.280; ZL5, 17.770; and ZL6, 25.800.

**NICARAGUA—YNFT**, 7.502; Granada, "La Voz de la Sultana," is heard signing off with march at 10:19 p.m. (Bromley)

**NORTHERN RHODESIA—ZQP**, Lusaka, broadcasts experimental transmissions daily from 10:30 a.m. to 12 noon on 80.5 meters; I believe the frequency is around 3.640 (listed, but may be as high as 3.690); on Sundays closes at 11:30 a.m. *English* and native programs are broadcast, and reports are invited. Address, Information Officer, P.O. Box 209, Lusaka, Northern Rhodesia. (BWSL) Bill Croston, Ohio, reports ZQP, 3.914, 10:30 a.m.-1 p.m., with weak signal and bad fade.

**NORWAY—**According to the BSWL, Oslo conducted tests for the British Isles in August, ending at 5 p.m., on frequencies announced as 6.130, 6.180, 9.540, and 11.735.

**NOVA SCOTIA—CJXC**, 6.010, Sydney, is being heard in Sweden at 6:30 p.m.; this is good reception inasmuch as CJXC is listed as using only 1000 watts.

**PALESTINE—**The "Sharq-al-Adna" station at Jaffa appears to have replaced its 6.710 frequency with 6.170; 6.135 and 6.790 are usually in parallel, heard opening at 11 p.m. in East (some Eastern DXers report sign-on as early as 10:30 p.m.) and around 9-10 a.m. in West.

**PANAMA—HOX series**, Panama City, is one of the most widely reported stations that took to the airwaves during 1946. It has been heard in such widely separated parts of the world as Northern Europe, Africa, and New Zealand.

Direct from W. T. Morrison, Chief Engineer, comes these schedules: HOXA, 15.100, 12 noon-9 p.m.; HOXB, 11.810, 9-11 p.m.; HOX, 940 kcs., transmits 12 noon-11 p.m. with 1,000 watts. The short-wave transmitter is a RCA Et-4750, 7500 watts. Spanish is the principal language used, but *English* news is scheduled for 6 p.m. and 10:55 p.m., news in Spanish is heard at 1 and 7 p.m.

Mr. Morrison is planning a special *DX broadcast, dedicated to readers of RADIO NEWS, for some time later in the winter.* Address of this station is Box 1335, Panama City, Republic of Panama.

**HOLA**, 9.505, Colon, "Radio Atlantico," is heard around 8:45 p.m. with an *English* program.

**PHILIPPINES—KZRH**, 9.640, Manila, is heard in Denmark closing at 11 a.m. (Friis) Australians report this station is heard "Down Under" around 6 p.m. (Gillett) A verification letter received by Mervyn Laubscher, South Africa, indicates this short-wave transmitter is affiliated with NBC; has an 18-hour schedule (*daily to 11 a.m.*), and uses a medium wavelength also. Address is Manila Broadcasting Company, Inc., 7th Floor, Insular Life

now you can  
**SEE and HEAR** the signal  
with the new **CA-12**  
*Signal Tracer*



**FEATURING**  
Simple Operation... only one connecting cable... No tuning Controls. A new Superior Instrument Product. Complete with Probe, Test Leads, Batteries and Instructions.

Price **34.85**

**Federated Purchaser**  
INCORPORATED  
distributors of **RADIO - ELECTRONIC**  
and **SOUND EQUIPMENT**  
80-RN PARK PLACE, N. Y. 7  
Phone: WH 4-2080

## ELECTRONICS

Electronic Technician Training Course. Qualify for Radio Communication (Commercial Government License); Radio Repair Service; or be an Industrial Electronic Technician. Register now for new classes starting every four weeks. Approved under G. I. Bill of Rights. Residence day and evening school. Write to

**ELECTRONICS INSTITUTE, INC.**  
21 HENRY, DETROIT, MICH.

In the Rocky Mountain Region It's  
**RADIO & TELEVISION SUPPLY CO.**

ELECTRONIC EQUIPMENT

152 Hobson Avenue, Pueblo, Colo.  
P.O. Box #892

"If we don't have it, we'll get it—  
or it can't be had! Phone 5729"

Now  
for **EVERY WORK SHOP!**  
**NEW** *Invention* **Electroplates**  
by **BRUSH**



**Easy to Plate CHROMIUM**

**GOLD, SILVER, NICKEL, COPPER**

For Pleasure and Profit!

If you have a workshop—at home or in business—you need this new Warner Electroplater. At the stroke of an electrified brush, you can electroplate models and projects—you can replat worn articles, faucets, tools, fixtures, silverware, etc. with a durable, sparkling coat of metal. Gold, Silver, Chromium, Nickel, Copper, Cadmium. Method is easy, simple, quick. Everything furnished—equipment complete, ready for use. By doing a bit of work for others, your machine can pay for itself within a week. So make your shop complete by getting a Warner Electroplater right away. Send today for **FREE SAMPLE** and illustrated literature. **ACT AT ONCE!**

- MODEL MAKERS
- MAINTENANCE
- HOBBY SHOPS
- HOME SHOPS
- SALVAGE PARTS

**WARNER ELECTRIC CO.** Dept. L-28  
1512 W. Jarvis Chicago 26, Ill.

**FREE Details & Sample!**

**WARNER ELECTRIC CO., 1512 W. Jarvis, Chicago 26, L-28**  
Gentlemen; Send Free Sample and Details to:  
Name \_\_\_\_\_  
Address \_\_\_\_\_  
City \_\_\_\_\_ State \_\_\_\_\_



Building, Manila, Philippines. Mr. Laubscher says he finds this station audible only for few hours prior to the 11 a.m. sign-off, strength is weak to fair; reception in July, when he sent in his report, was much better than it has been this winter. In New Zealand, KZRH is a good signal from 4 a.m. (Milne)

KZRM, 9.590 (listed as 9.570), is being heard in Denmark starting at 10 p.m. (Friis)

POLAND—Radio Polskie, 6.100 (varying), has English news now at 3:15 p.m., according to British sources. Some reporters still list the time as 3 p.m., however.

PORTUGAL—CSX, 6.374, Lisbon, has a short session between 3:50-4:15 p.m. (Milne) Is good signal in New York between 5:30-7 p.m. sign-off. (Beck)

RUMANIA—According to the official house organ, "Night-Owl," of the *Jonoping-Huskvarna DX Club*, Sweden, *Radio Romania Libera*, Bucharest, operates on a wavelength of 48.31 meters (assigned to a frequency of 6.189), 12:30-2 p.m.

The Bucharest transmitter on 9.252, *Radio Dacia Romania*, is heard in Sweden at 8:30 a.m. (*Night-Owl*) I believe English news is scheduled for that time.

SIAM—HSPP, 5.990, Bangkok, signs off at 9:45 a.m.; program is mostly in Asiatic languages. (Dilg) Reporters in Australasia say some English is heard.

SOUTH AFRICA—Johannesburg IV, 6.095, is heard in Sweden at 12 noon. (*Night-Owl*) Capetown, 5.877, heard 11:45 p.m.-12:30 a.m. now, with BBC news relay from London at 12 midnight. (Sutton)

FET15, 7.045, *Radio Cordoba*, is a good signal in New York at 6:55 p.m. sign-off. (Beck)

SWEDEN—Signals are improving greatly from SBT, 15.155, Stockholm, in the North American daily beam (*English* and *Swedish*), 10-10:55 a.m.; after usual chime interval signal, continues in Home Service, has English again around 12:35 p.m., leaves the air usually at 1:15 p.m.; the 10.780 frequency (SDB-2) is good in Home Service all afternoon to around 5:45 p.m. sign-off.

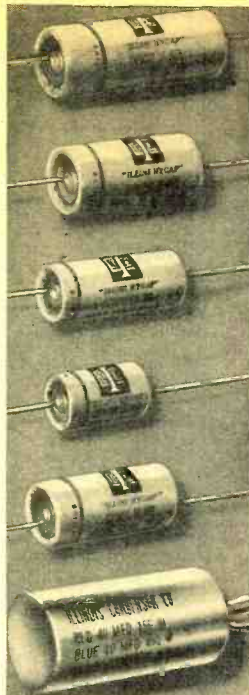

Now in full production on

**ELECTROLYTIC CAPACITORS**

to serve you better . . . faster!

Our new plant has been specially designed for the manufacture of Electrolytic Capacitors. Newest production techniques, closer, more rigid control, air conditioning for better quality and employee working conditions and finest materials . . . all are features which insure you of the highest product standards. Illinois' Capacitors have been used by leading concerns of the nation for over 12 years. They have an unsurpassed reputation for lightweight, compact construction combined with ruggedness for long life.



Your copy of our latest catalog is ready for you. Write for it today.



**ILLINOIS CONDENSER CO.**  
1616 NORTH THROOP STREET • CHICAGO 22, ILL.

# WATCH RADIOMART for Values . . .

**Resistor Kits of Chosen Values**  
EACH KIT CONTAINS 100 INSULATED CARBON RESISTORS. ALL RMA COLOR CODED. ALL STANDARD BRANDS. EVERY ONE IS A POPULAR REPLACEMENT SIZE.

**KIT No. R050L**— $\frac{1}{8}$  &  $\frac{1}{2}$  WATT; RANGE FROM 10 to 10000 OHMS; 5 each of 20 good sizes. Price per kit . . . \$3.50

**KIT No. R050H**— $\frac{1}{8}$  &  $\frac{1}{2}$  WATT; RANGE FROM 14000 to 20 MEGOHMS; 4 ea. of 25 good sizes. Price per kit . . . \$3.50

**KIT No. R120**—1 & 2 WATT; RANGE FROM 10 OHMS to 2.2 MEGOHMS; 5 each of 20 good sizes. Price per kit . . . \$5.50

**TRICOR SOLDER**

The best—1 lb. roll . . . \$ .66

**ANTENNA WIRE—50' ROLLS**  
TINNED COPPER STRANDED  
No. 18. 12 rolls for only . . . \$4.25

**SENSATIONAL!!!**

**52 SILVERED MICAS**—List price \$63.50; 2 each of 26 types ranging from 27 to 2700 mmfd. Your Special Price . . . \$4.95  
20% with order—Balance, including postage, C.O.D. Reliable, Prompt Service.

**G. E. REACTOR—A PHENOMENAL BARGAIN**—THIS HUSKY G. E. REACTOR IS RATED AT 116 H @ 150ma; 1350V, OPERATING; 3000V INSULATION; 5.5 OHMS DC RESISTANCE;  $6\frac{3}{4}$ " L x  $5\frac{1}{2}$ " W x  $6\frac{1}{2}$ " H; Stock No. L745. A Steal at . . . ea. \$5.95

**Now in Stock—Immediate Delivery Price**

723 A/B Tube and Socket . . . . .	\$7.95
Socket for 723 A/B . . . . .	.15
No. 22 Hook-up Wire—Solid—50' Roll . . . . .	.29
*Kit of 12 Rolls—6 colors . . . . .	1.69
Jones Plug No. P406LAB . . . . .	.25
Jones Socket No. S406LAB . . . . .	.30
UHF Low Loss Octal Sockets . . . . . 12 for	2.25
Octal Sockets—Push-on—with ring . . . . . 12 for	.75
4-Prong Sockets—Push-on—with ring . . . . . 12 for	.75
Focus Coil for AN plan 12 scope; 4500 turns	
No. 29 Wire: 264 ohms dc resistance . . . . .	1.95
250 mmf-1200 wv-xmit. mica . . . . .	.30
400 mmf-2500 wv-xmit. mica . . . . .	.40
.0051 mfd-2500 wv-xmit. mica . . . . .	.95
.1 mfd-500 wv-G.E. Pyronol . . . . .	.75
.15 mfd-2500 wv-G.E. Pyronol . . . . .	1.95
Stupakoff Feed-thru Ins-Kovar: $1\frac{1}{2}$ " L, including	
solder lugs each end . . . . .	.15
Knob. Xmit Finger Grip: Black; $1\frac{1}{2}$ " hex set	
screws . . . . .	.20
Antenna Reel. Aluminum, with handle; 5" dia.	
x $\frac{1}{8}$ " W . . . . .	1.25
Rotary Switch—SP5T—prog. short—single	
ceramic wafer—silver plated contacts—2	
click ball index—Oak . . . . .	.59
Rotary Switch—DPDT—2 wafers and shield—	
3 dummy lugs—long throw detents—2 click	
ball index—Oak . . . . .	.49
Rotary Power Switch—3P3T—Arrow H. & H.	
15a—125v; 10a—250v . . . . .	1.25
Variable Air Trimmer—3 to 35 mmf—10 plate . . . . .	.29
Variable Air Trimmer—5 to 55 mmf—19 plate . . . . .	.29

**Just Arrived**

<b>POWER TRANSF.</b> —115v/50-60 cps; 900v-100ma-CT; 6.3v-5a-NCT; 5v-2a; double half shell; static shield. Stock No. TP536 . . ea. \$4.50
<b>FILAMENT TRANSF.</b> —110-220v/50-60cps; 11.7v-3.25a. Stock No. TF841 . . ea. \$3.50
<b>FILAMENT TRANSF.</b> —Pri.-81/163/230v; Sec.-11.7/5.85v @ 3.25a; 50-60cps; .038KVA; .75KV Insulation. Stock No. TF744 . . ea. \$3.00
<b>INPUT TRANSF.</b> —60mc; shielded; ceramic core; intuned; two windings; brass case; $1\frac{3}{8}$ " sq. x $1\frac{3}{16}$ " (overall). A beauty for experimenters. Stock No. TI576 . . ea. \$1.25
<b>OUTPUT TRANSF.</b> —Push-pull; for use with pair of 50L6, 35L6, 25L6. Stock No. TO858 . . ea. \$1.15

**RADIOMART, Inc., Dept. RN 147, 149 Riverdale Ave., Yonkers, N. Y.**

Gentlemen: Please rush my copy of your latest Bulletin 11, containing a thousand and one bargains in radio parts.

Name . . . . .

Address . . . . .

**Check one**

- Service Dealer  Ham  
 Laboratory  School



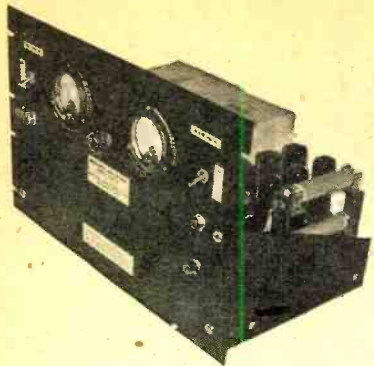

**The Manufacturer of PRECISION REGULATED POWER SUPPLIES is not our only line**

**We are Procurement Agents for many hard-to-get items.**

**Some of our bargains include:**

Wire, #22 West. Elect. Switchboard, double insulation.....	Per 1000 ft.	\$6.50
Resistors, 1/2 Watt.....	Per 100 ft.	1.75
Resistors, 1 Watt.....	Per 100 ft.	2.35
Resistors, 2 Watt.....	Per 100 ft.	2.75
Meter, 3" GE Type D041; 0-30 MA.....		4.95
Meter, 3" Westinghouse Type NX35; 1 Mil mvt.....		4.65
Meter, 2" Weston 506; 1 Mil mvt.....		3.65
Meter, 3" Weston 301; 1 Mil mvt.....		4.75
Meter Multiplier, Weston, 5 Megohm, precision wire wound, 5 KV insulat....		2.15
Tube, 836.....		2.65
Tube, Cathode Ray, 5HP4, complete with socket, shield, and mounting.....		9.45
Tube, 6AG7; 6AG7; 6SL7; 6SJ7; 6H6; 6SG7; VR150; VR105; 2X2; 6L6; 6V6; etc.....		.73
Tube socket, porcelain, octal.....		.13
Microswitch.....		.35
Condenser, transmitting, W.E. Oil, .00035MFD, 25,000 Volt.....		7.10
Condenser, CD Type TLA, 4MFD, 600 V.....		1.25
Condenser, CD Type TLA, 2MFD 1000 V.....		1.15
Condenser, Aerovox Type GL, Electrolytic 8 MFD 600 Volts.....		.85
Condenser, bathtub, all sizes, average.....		.23
Motor, 115VAC 60 cy. 1750 RPM, 1/50 HP complete/w 6:1 reduction gear & Mtg. assy.....		8.25

**We also have in stock a complete line of Transformers, Chokes, Power Resistors, Variable Condensers, Cable, Cords, Terminal Bds., Pots, Insulators, Switches, etc.**

**IF YOU WANT IT—WE HAVE IT**

**ATT.: Manufacturers, Jobbers, and Exporters —Inquire as to our Quantity Prices.**

**Facilities available for Light Manufacturing and Assembling.**

**NATIONAL RADIO SERVICE CO.**

Reisterstown Rd. & Cold Spring Lane  
Baltimore 15, Md.

**ELECTRONIC COMPONENTS**

New 5CPI's in original sealed cartons (6-lbs.).....	\$7.95
New 3BPI's in original sealed cartons (5-lbs.).....	\$5.95
Sockets for above, with tube, 45c; otherwise.....	\$.90
New 5CPI steel shields, cadmium plated (3-lbs.).....	\$.85
New 954, 953, 956, 957 Acorn tubes in original cartons, not rejects, postpaid in U. S. & Canada.....	\$.89
Westinghouse 4 1/2" dia. 0-200 D.C. microammeter.....	\$6.50
Westinghouse 4 1/2" dia. 0-150 D.C. voltmeter.....	\$5.50
Westinghouse 4 1/2" dia. 0-20 D.C. milliammeter.....	\$4.25
Miniature 1/2 wave selenium rect. 18v 1/2-lma., 5 for.....	\$1.00
Matched pairs sel. rect. for meters 1/2 lma., 2 for.....	\$.50
100 feet spaghetti 1/2 HV cambric, 1/2 plastic (2-lbs.).....	\$1.00
12-18v electric controlled carbon pile volt. regulator.....	\$.65
115-15v-3A, 1.4v-2A & 230-30v-3A, 2.8v-2A, 50 watt 60 cyc. herm. sealed xformers, black crinkle (4-lbs.).....	\$1.25
New dynamotors 24v DC to 240v DC 30 ma (6-lbs.).....	\$2.75
New dynamotors 24v DC to 270v DC 120 ma (6-lbs.).....	\$3.25
New dynamotors 24v DC to 450v DC 200 ma (8-lbs.).....	\$4.25
Relays 24v DC DPDT plus DT grounding, HV Insul.....	\$.89
Astaire L-40 Phono pick-up arm with crystal.....	\$2.90
Phono motors 9" turntable 110v/60 cycle.....	\$4.95
New J-38 Signal Corps keys with switch (1-lb.).....	\$.89
RG-34/U 72 ohm Coax 40' or less, 8 cents a foot; in coils 50-99', 6.5 cents a foot. Handles up to 2kw.	
Seisyn 115v/60cy. transm. & recv. (12-lbs.) 2 for.....	\$8.50
G.E. 57.6v/400cy. differential generators (adds or subtracts electrical angles) (3-lbs.) each.....	\$2.45
Headset Hi to low imp. UTC xformers with jack & plug.....	\$.49
Antenna, Osc. R.F. & peaking coils, kit of 10 (1-lb.).....	\$1.25

Please include sufficient shipping postage. We also ship C.O.D. orders. Write for free electronic bargain list.

**OHMEYER ENGINEERING LABS.**

Fairview Blvd. Dept. C. Hempstead, N. Y.

**SWITZERLAND—HER3, 6.165** (listed as 6.166), Berne, is heard leaving the air at 5:32 p.m. (Bromley) **HER4, 9.535, not HEI4, 9.539**, is being used by Berne between 12:20-1:40 a.m., with HER3, 6.165, in parallel; opens with setting-up exercises; has German news at 12:45.

**TAHITI—FO8AA, 6.980** (appears higher, about 6.99), Papeete, *Radio Club de Tahiti*, appears to be scheduled 10-11:45 p.m. or to 12 midnight, irregularly, Tuesdays and Fridays; uses French marching song (not "La Marseillaise") prior to closedown which is usually without announcement. (Dilg) Heard 10 p.m.-12 midnight a recent Saturday. (Croston)

**TANGIERS—**The station on approximately 6.190, heard in England between 3-5 p.m. (not complete schedule), uses *English*, Spanish, French, and Arabian languages; identifies about every half hour in *English* as "Radio International, broadcasting from Tangiers." Usually has *English* at 4:45 p.m., but no news has been noted; poor signals. (Harrison)

**TURKEY—TAP, 9.465, Ankara**, is still reported on Sundays with the "Postbag" program, and to England, also in *English*, on Thursdays and Mondays, for fifteen minutes, all these periods beginning around 4:30 p.m. (Sternfelt) Has had *CWQRM* here in West Virginia. On the same frequency is heard weakly some days at 12:45 p.m. in regularly-scheduled *English* news period; now coming through to West Coast again. (Cooper)

**U.S.S.R.—Komsomolsk, 9.565**, signs on at 9 p.m., off at 12:30 a.m., and back on at 3 a.m.; has *English* news now at 4 a.m. (Balbi) Some days Moscow can be heard in *English* beam to Britain at 12 noon on several frequencies in the 19-m. band (15.385, 15.412, 15.440). (Harris)

Although not announced, a Russian

transmitter is being heard mornings on 11.720, from around 7 to 8:15 a.m., relaying Moscow's beam to North America; frequencies announced at 7:15 a.m. recently were 11.63, 15.18, 15.36, and 17.82. The 7 o'clock newscast is followed by Review of the Soviet Press and then a commentary; further news is heard at 8 a.m.; at 7:45 a.m. they announce addition of 9.565, 11.89, and 15.44.

New frequencies in Moscow's Home Service, heard after 10 p.m. on West coast, include 9.715, 15.23, 11.745, and irregularly, 11.87. (Balbi)

Excellent signals are heard in England from Moscow on 6.160 at 5 p.m. when *English* news is presented. The transmitter on 6.020 (probably Kiev) is heard in European languages around 4-5 p.m.; Kremlin clock is heard striking at 5 p.m.; excellent signal. (Harrison)

Tiflis, 11.960, is heard 1-2 a.m. or later and also at 1:15 p.m., all Russian; Petropavlovsk (Kamchatka), 6.070, is heard on Sundays, 1-1:35 a.m., in British Columbia blots out Toronto; mostly music. (Cooper)

Kiev, 11.72, is being used yet in evening transmission to North America, 6:20-9 p.m., in spite of announcement of operating on 6.020; between 9-9:15 p.m. sign-off, uses Yiddish. Frequencies announced as used between 6:20-7:30 p.m. to North America include 7.36, 11.89, and 15.73; only the 7.36 one is audible in New York; transmitters announced for 6:20-9 p.m. are 7.24, 7.30, 9.48. (Beck) Some evenings they announce and are heard between 6:20-7:30 p.m. on 15.17.

**U.S.A.—**This interesting comment regarding reception of American short-wave broadcasters along the eastern coast of South America comes from Charles Mohr, written from Sao Salvador, Brazil: "I have been observing a phenomena the past few weeks

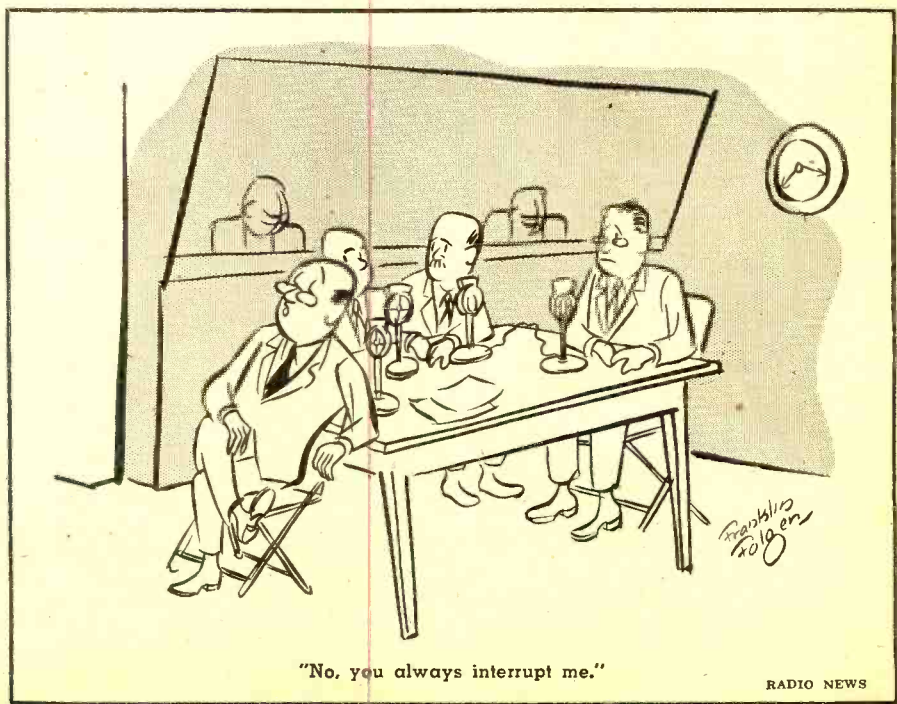

"No, you always interrupt me."

RADIO NEWS



which I have never heard about before. It may have been previously recorded, but if so, it has been unknown to me. From my observations, the beam of American short-wave stations is increasing in the number of degrees from 0 to 360. Stations on the East Coast of the United States (WRUA, WRUL, for example), beamed to Europe, have been heard fairly well near the end of October, whereas in September they were absolutely silent. Stations on the East Coast (such as WLWO, 11.790, for instance), beamed to Latin America, are heard with much poorer signals on the east coast of South America than they were during September. Stations on the West Coast of the United States (such as KNBX, 15.250, KWIX, 17.760), with main beams to China and Japan and with reciprocal (plus 180°) beams, which were heard with fair signals on the southern coast of Brazil, are now unheard. San Francisco stations beamed on Central and Southwest Pacific (KGEI, 15.130, and others), with reciprocal ordinarily over the eastern United States or the Caribbean, are being heard very well now." On the return trip to the United States, Mr. Mohr promises to let us know of any further developments in his observations regarding signals of U.S.

VATICAN—Listeners in England report HVJ, 15.100 (listed as 15.095) and 9.660, has English news at 9 a.m., and on 5.970 (listed as 5.971) at 1:15

p.m. BSWL) The 6.190 transmitter is heard in foreign languages during the afternoon to about 4 p.m.; some days the 9.571 transmitter has a talk in English at 2:30 p.m. (Harrison)

WESTERN SAMOA—ZMB6, 7.700, *Apia Radio*, which tested in early autumn around 12 midnight-1:05 a.m., has not been heard lately. (Balbi, Dilg)

YUGOSLAVIA—*Radio Belgrade*, 6.150, is heard 1-6 p.m.; the 9.420 (listed as 9.418) frequency is heard between 12 midnight-2 a.m.; both have fair to good signals. (Croston)

**ACKNOWLEDGMENTS**

ANGLO-EGYPTIAN S U D A N—Short. AUSTRALIA—Gillett; "Sky-rider," ADXC; Wood, Radio Australia; Pye, Hallett. BRAZIL—Mohr. BRITISH COLUMBIA—Cooper, Virgin. BURMA—Burma Broadcasting Service. CALIFORNIA—Balbi, Crossley-Meates, Gould, Dilg, Curtiss. CEYLON—Radio SEAC, SEAC Forces' Radio Times. COLORADO—Woolley. CONNECTICUT—Beauregard. DENMARK—Friis; Johansen, Danish Short Wave Club. DISTRICT OF COLUMBIA—Howe, URDXC; Scully, Havlena, U.S.S.R. Embassy, Eaton. ENGLAND—Jones, Watkinson, Bowes-Taylor, Simpson, Short Wave News, Harrison, Hunt, ISWC, ISWL, Rowden, Short Wave Review, Friend, McGee, BSWL, Tonks, Norris, Daniels, Chang, Hall, Mitchell, White, Lloyd, FRENCH EQUATORIAL AFRICA—

Jacques, Radio Brazzaville. HOLLAND—Kœlmans; Startz, PCJ; de Groot. INDIA—Laljee. INDIANA—Brimlow. KANSAS—Seckler. LOUISIANA—Smith, Crandall. MALAYA—Department of Broadcasting. MARYLAND—Grivakis, Weyrich. MASSACHUSETTS—Kernan, French, Florentine, Harris, Holzman, Sternfelt. MISSOURI—O'Connor. MONTANA—Steinmetz. NEW JERSEY—NNRC; Williams, American QLS Bureau; Wooley. NEW YORK—BBC, Casey, Legge, Australian News and Information Bureau, Ignoll, Beck, March, Sink, Dellins. NEW ZEALAND—Barr, NZDXC, Milne, Gray, Cushen. NORTH CAROLINA—Ferguson. NOVA SCOTIA—Brooman. OHIO—Berg, Sutton, Croston, Gates. ONTARIO—Bromley, Moss, Brook. OREGON—Hayre. PANAMA—Morrison, Radio Centro Americana. PENNSYLVANIA—Black, Callahan, Bachman, Cooley, Znaidukas. POLAND—Radio Polskie, Radio i Swiat. QUEBEC—Gauvreau. SCOTLAND—Wilson, Morris. SOUTH AFRICA—Laubscher. SWEDEN—Bergstrom, Skoog, Erik Petersson; Samsioe, Radiotjanst; Ekblom, Nils Johnsson; Sundback, "Night-Owl"; Carl-Eric Petersson, Lindhe, Gilbert Andersson; DX-News. TENNESSEE—Seaton. TEXAS—Thompson, Rice. VENEZUELA—Raper. VERMONT—Podall. VIRGINIA—Norris. WEST VIRGINIA—Rupert, Reese, Gonder. WISCONSIN—Reed.

# FREE!

## Radionic Catalog



Thousands of items illustrated, described and priced in our new 1947 catalog. Hams, Servicemen, Experimenters, Engineers, Schools, Institutions, Govt. Depts., Industrial Organizations, Laboratories, etc. will find this book a great help in their search for "hard-to-find" equipment.

**NEW!**

BLILEY Crystal-Controlled Oscillator  
A superb test instrument  
**\$69.50**  
WRITE FOR DETAILS

**RADIONIC EQUIPMENT CO.**  
170 Nassau St., Dept. 51, New York 7, N. Y.

Please send me a copy of your 1947 catalog.

Name .....

Address .....

City ..... State .....

## Revolutionary ... VOICE RECORDINGS on PAPER!

with the new

### Mail-A-Voice

A new electronic wonder — you can record your voice on a paper blank about the size of a dinner plate! No grooves—no scratches—no needles to fuss with—no skill needed to make excellent "voice letters"!

- 3 1/4 minute recording
- Can be folded for mailing
- Costs only a few pennies each
- Can be used over and over again
- Plays back on any Mail-A-Voice
- Excellent fidelity from 100 to 3000 cycles.



**Many Uses for Mail-A-Voice**  
For those quick, personal reports...  
an unbeatable "vocal scratch pad" ... inter-office memos ...  
doctors ... attorneys ...  
salesmen ... announcers ... children and others. It's light weight, 13 1/2 pounds and attractively cased in grey metal. For AC only.

Shipped prepaid anywhere in U.S.

Only **\$49.50**





## CW MEN:

YOU WANT ACTIVITY AND  
PR GIVES IT TO YOU!

Chirpy signals . . . due to sluggish crystals . . . are a thing of the pre-war past for amateurs who insist on PR Crystal Controls. Yes—PRs follow your bug at high speed—on the highest frequencies. You get perfect keying activity without sacrifice of crystal output by excessive "backing off." This means more excitation to the final, higher input potential, more watts in the antenna, better final efficiency . . . clean keying with the weights off!

PR Crystal Controls are unconditionally guaranteed. Low drift at all frequencies . . . less than 2 cycles per MC. Accurate within .01 per cent. Exact frequency (integral kilocycle) at no extra cost! Gasket sealed against contamination. Stable under the most severe high power output conditions. Available for ALL BANDS at your jobber now! Accept no substitute! Petersen Radio Company, Inc., 2800 West Broadway, Council Bluffs, Iowa. (Telephone 2760)

10 Meters—PR Type Z-5 . . . . . \$5.00  
20 Meters—PR Type Z-3 . . . . . 3.50  
40 and 80 Meters—PR Type Z-2 . . . . . 2.65



**RADIO COURSES**

- RADIO OPERATING — CODE
- RADIO SERVICING — ELECTRONICS
- REFRIGERATION SERVICING

Personal Counselling Services for Veterans  
Write for Latest Trade & Technical Catalog  
**Y.M.C.A. TRADE & TECHNICAL SCHOOLS**  
7 W. 64th Street New York City

**Specify SAUERISEN**  
**ACIDPROOF CEMENTS—COMPOUNDS**  
FOR  
Tanks, Sewers, Stacks, Floors  
Technical cements for all purposes.  
Send sketches or samples  
Sauerisen Cements Company · Pittsburgh 15, Penna.

## The Electroplex (Continued from page 39)

feedback between the plate and grid of  $V_{1B}$  through  $C_1$  and  $R_1$ . The feedback is most effective for the higher-frequency components of the transient negative voltage which is applied to the grid when the control switch is opened at a time when  $V_{1B}$  is conducting. The circuit is thus rendered relatively insensitive to the transient and tends to wait until  $V_{1A}$  begins conduction, then terminates the dash in the normal manner for correct timing.

Condenser  $C_2$  connected between the fixed contacts of the control switch remedies a slight lag in response when the control switch is moved to the dot position.

A different type of relay may be used, provided that the series resistance of the relay coil and  $R_2$  totals 7500 ohms. The plate current of  $V_{1B}$  is about 7 milliamperes but the relay should be able to close on 5 milliamperes.

The monitoring oscillator uses the amplifier section,  $V_{3A}$ , of a combination rectifier-amplifier tube. It is a blocking oscillator such as is used in sweep generators for radar and television equipment. It produces short pulses separated by time intervals much longer than the pulses. The output signal therefore has a very high harmonic content, resulting in a distinctively musical tone.

The fundamental frequency of the oscillator is dependent primarily on the discharge time of the grid condenser,  $C_3$ , and is practically independent of the resonant frequency of the tank circuit. A potentiometer,  $R_{15}$ , controls the positive bias to which the grid leak,  $R_{17}$ , is returned, thereby controlling the frequency of the audio tone. The fundamental frequency is variable from about 400 to 2000 cycles per second. The frequency control potentiometer,  $R_{18}$ , is mounted at the upper right-hand corner of the front panel.

Condenser  $C_6$ , not ordinarily found in blocking oscillator circuits, was found necessary in order to lengthen the pulses which otherwise were so short that their energy content was very low. The result was greater audio output power and a more pleasing tone quality.

The oscillator transformer,  $T_1$ , is a universal midget output type which has six taps on the secondary winding. It is connected to provide an impedance transformation from 8000 ohms plate-to-plate to voice coil. The oscillator tube,  $V_{3A}$  is rather lightly loaded and draws only about ten milliamperes plate current. The oscillator is a surprisingly efficient noise-maker, the volume control being normally set at about one-third of maximum. The volume control potentiometer,  $R_{16}$ , is mounted at the upper left of the front panel.

Since the frequencies of both the tim-

## REMARKABLE VALUE



**Famous Quality**  
PORTABLE RADIO-PHONO COMBINATION KIT

- 5-tube superheterodyne radio
- 3-tube amplifier
- Large P.M. Speaker
- High gain crystalpick-up

Model RP-55P (illustrated) Ready for assembly, . . . . . **\$31.95**

### ALSO AVAILABLE

Kit Model S-5P—5-tube superhet radio, less tubes . . . . . \$10.95  
Kit Model RP-3. Portable Phono, with tubes . . . . . \$19.95  
Kit Model RP-55. Combination Radio & Phono, with tubes . . . \$34.95  
Kit Model RC-3. Portable Record Changer, with tubes . . . . . \$39.95  
Kit Model PB-4. Portable Battery Radio Kit, with tubes . . . . . \$15.95  
All Kits Supplied Less Wire and Solder  
Write for Descriptive Catalog K

**RADIO KITS COMPANY**  
120 Cedar Street, New York 6, N. Y.

## QUALITY HEADSETS

Manufactured to meet rigorous U. S. Government specifications! Both types extremely sensitive and employ matching transformers for hi-impedance outputs. Each employs miniature phone units with Alnico magnets. The "MINIATURES" are a lightweight, compact type with soft rubber ear tips, flexible rubber cord, rubber spring-clip and standard phone plug. **\$2.95**  
PRICE COMPLETE . . . . .

"NOISE-PROOF" Headsets employ the same hi-efficiency phone units but in rubber-cushioned magnesium earcaps that fit snugly and comfortably over each ear. Ideal for hams and commercial operators, recording engineers, aircraft pilots and others. Their superiority for comfort and efficiency, over regular headsets, **\$5.95** is overwhelming.  
PRICE COMPLETE . . . . .

Send check or money order for Post-paid delivery. Dealer & Distributor inquiries invited on quantity.

**TAYBERN EQUIPMENT CO.**  
120 GREENWICH ST., NEW YORK 6, N. Y.

## RADIO TUBES

Most Critical Types in Stock  
50L6, 1A7, 35Z5, etc.  
Brand New, in Sealed Cartons  
100% Guaranteed  
Repairmen and Dealers, Write For List at Trade Discounts  
**RADIO-EXPERTS**  
178 E. 33rd Street Paterson 4, N. J.

GET ON SUN'S MAILING LIST!

**SUN RADIO**  
& ELECTRONICS CO., Inc.

122-124 DUANE ST. · NEW YORK 7, N. Y. · Barclay 7-1840

RADIO NEWS



## HAM SPECIALS from KENYON

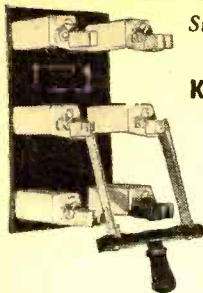

Sturdily constructed  
**ANTENNA  
KNIFE SWITCH**

now only  
**49c**

Double pole, double  
throw, on fully insu-  
lated porcelain base.



### STANDARD ALL-STEEL CABINET

for Receivers and Low-  
powered Rigs.

Special

Size 8 $\frac{3}{4}$ " x 19" panel.  
Black crackle finish, carry  
handles—hinged top.

**\$6.50**

NO C. O. D. ORDERS—PRICES F. O. B. WASHINGTON

### KENYON RADIO SUPPLY CO.

2214 14th St. N. W., Columbia 3161  
WASHINGTON 9, D. C.

Distributors of Electronic Equipment

*Slanted  
FOR  
SERVICE!*

### THE NEW MULTIPLEX

MODEL  
458



### Volts - Ohms - Mils - Output

Back of the bench, out of the way, but easily readable and always ready for instant use. Those are the features that have made the Multiplex Model 458 V.O.M. a shop and laboratory favorite.

All popular ranges of A.C. and D.C. volts, A.C. and D.C. mils, ohms and output are conveniently available. Readings are sharply visible on the big 5 $\frac{1}{2}$ " meter.

D.C. Volts . . . 0 to 2,000 . . . in 6 ranges  
A.C. Volts . . . 0 to 1,250 . . . in 5 ranges  
D.C. Mils . . . 0 to 100 . . . in 3 ranges  
A.C. Mils . . . 0 to 250 . . . in 3 ranges  
Ohms . . . 0 to 2,000,000 in 6 ranges  
Output . . . . . 5 ranges

The Multiplex Model 458, built to high industrial standards, is priced remarkably low—only \$26.00 net. Write today for new circular.

**CHICAGO INDUSTRIAL INSTRUMENT CO.**  
219 West Chicago Avenue  
CHICAGO 10, ILLINOIS

ing circuit and the oscillator are somewhat dependent on the plate voltage, it is desirable to maintain a constant load on the power supply. For this reason, the oscillator runs continuously with the output being keyed by short-circuiting the voice coil through the back contact of the keying relay,  $RL_1$ . This arrangement affects stable and clickless operation of both the oscillator and the timing circuit.

### Power Supply

The power supply circuit is rather conventional and requires little comment except to point out the advantage of connecting the pilot light in series with the power line. It serves as a line fuse as well as an on-off indicator. Also, it indicates whether the audio oscillator is functioning properly. If the brilliance of the light changes when the oscillator is keyed, it is an indication that the oscillator is too heavily loaded and/or is not blocking. To reduce the loading, the output connection should be made to a lower impedance tap on the secondary winding of the oscillator transformer. The key has been found to operate satisfactorily from both a.c. and d.c. 115 volt power lines.

### Construction

The arrangement of parts, as illustrated, is governed primarily by the desirability of minimizing waste space in order that the instrument may be as compact as possible. Fortunately, since the keying frequencies are less than 20 cycles, the layout problem is not complicated by consideration of stray capacitances and the leads may be as long as is expedient. However, leakage conductance through insulation or condensers must be minimized in order to prevent faulty operation. The condensers should be of the best quality and have a low leakage conductance.

The control switch was made from parts of an old "bug" and is mounted upside down on the bottom of the chassis. Both of the fixed contacts are mounted on a strip of lucite which is visible in the photograph. The lucite strip is secured in place of the arm which had previously supported the adjustable stop for the dot side of the old "bug."

The potentiometer  $R_3$  and  $R_{33}$  are mounted on brackets secured to the chassis and their shafts are sawed off and slotted flush with the right-hand side of the cabinet where holes are provided for their adjustment. From the outside, these adjustments are inconspicuous, looking like ordinary screw heads.

The keying terminals are mounted on the back of the cabinet. The back and bottom of the cabinet are perforated with  $\frac{1}{4}$  inch holes to provide ventilation. Ventilation holes are also drilled in the chassis wherever space can be found for them. The heat within the cabinet induces an adequate flow of air in through the bottom of the cabinet, which rests on rubber

## METERS SPECIAL OFFER

Surplus—New—Guaranteed

### SET 1

#### D. C. MILLIAMMETERS

3 Matching Simpson Meters, 3 $\frac{1}{2}$ ", round, flush, bakelite cases, 0-15 MA, 0-100 MA, 0-200 MA. Excellent for "ham" rigs. Your cost for these 3 meters, postage paid anywhere in U.S. or Canada, ONLY..... **\$9.75**

### SET 2

#### A.C. VOLTMETER, A.C. AMMETER, and D.C. AMMETER

3 Triplett Meters, 3 $\frac{1}{2}$ ", round, flush, bakelite cases, 0-150 volt A.C., 0-75 Amperes A.C. and 0-15 Amperes D.C. Your cost for these 3 meters, postage paid anywhere in U.S. or Canada, ONLY..... **\$8.95**

### SET 3

#### A.C. VOLTMETER and A.C. AMMETER

2 matching 3 $\frac{1}{2}$ ", G.E. round, flush, bakelite cases, 0-150 volt and 0-80 Amperes. Your cost for these 2 meters, postage paid anywhere in U.S. or Canada, ONLY..... **\$7.95**

### SET 4

#### A.C. VOLTMETER

Westinghouse Aircraft Meter, flush, round, bakelite case, 2 $\frac{1}{2}$ ", 0-150 volt A.C. Black scale, luminous markings, suitable for use from 25 to 125 cycles.

#### R.F. AMMETER

Simpson 2 $\frac{1}{2}$ ", round, flush, bakelite case, 0-3 Amperes Radio Frequency White scale.

#### D.C. MILLIAMMETER

G.E. DW-41, 2 $\frac{1}{2}$ " round, flush, bakelite case, 0-1 MA mvt. Special scale marked 0-500 MA and 0-140 D.C. Volts-MA. Complete with paper V-O-MA scale.

#### D.C. MILLIAMMETER

Gruen, 2 $\frac{1}{2}$ ", round, flush, bakelite case, 0-3 MA, white scale.

#### D.C. AMMETER

G.E. 2 $\frac{1}{2}$ " round, flush, stamped metal case, moving iron vane type, 0-15 Amperes D.C.

#### RECTIFIER TYPE MICROAMMETER

Hickok 2 $\frac{1}{2}$ ", round, ring mounted, metal case, 0-700 microamperes D.C. Full scale, 0-100 microamperes D.C. Half scale, 0-1 M.A. A.C. Full scale. Complete with self contained half wave rectifier. Black scale, luminous markings, scale 0-10. Your cost for these 6 meters, postage paid anywhere in U.S. or Canada, ONLY..... **\$9.95**

## MARITIME SWITCHBOARD

336 Canal Street  
New York 13, N. Y.



# NOW—A REALLY HIGH-POWERED— Radio Engineering Library

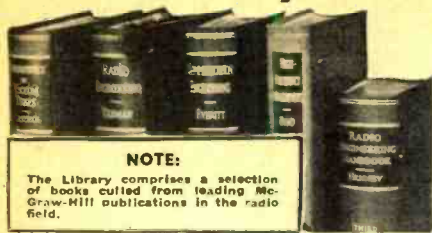

**NOTE:**

The Library comprises a selection of books culled from leading McGraw-Hill publications in the radio field.

- especially selected by radio specialists of McGraw-Hill publications.
- to give most complete, dependable coverage of facts needed by all whose fields are grounded on radio fundamentals.
- available at a special price and terms.

THESE books cover circuit phenomena, tube theory, networks, measurements, and other subjects—give specialized treatments of all fields of practical design and application. They are books of recognized position in the literature—books you will refer to and be referred to often. If you are a practical designer, researcher or engineer in any field based on radio, you want these books for the help they give in hundreds of problems throughout the whole field of radio engineering.

**5 VOLUMES, 3559 PAGES, 2558 ILLUSTRATIONS**  
1. Eastman's FUNDAMENTALS OF VACUUM TUBES

2. Terman's RADIO ENGINEERING
  3. Everitt's COMMUNICATION ENGINEERING
  4. Hund's HIGH FREQUENCY MEASUREMENTS
  5. Henney's RADIO ENGINEERING HANDBOOK
- 10 days' examination. Easy terms. Special price under this offer less than books bought separately. Add these standard works to your library now; pay small monthly installments, while you use the books.

10 DAYS' FREE EXAMINATION—SEND COUPON

McGraw-Hill Book Co.

330 W. 42nd Street, New York 18, N. Y.

Send me Radio Engineering Library, 5 vols., for 10 days' examination on approval. In 10 days I will send \$2.50 plus few cents postage, and \$4.00 monthly till \$28.50 is paid, or return books postpaid. (We pay postage on orders accompanied by remittance or first installment.)

Name .....

Address .....

City and State .....

Company .....

Position ..... RN 1-47

Come to the famous

**COYNE**  
TRAINING SHOPS

where you learn by doing



**TRAIN FOR RADIO-ELECTRONICS IN A FEW WEEKS**

**Prepare For A Good Job Now With A Lifetime Future!**

Trained Radio-Electronics men needed now. They will be needed too in the years to come. Don't be caught napping. Get a Radio training now and be ready. Learn by Doing. Free employment service for life after graduation. Many earn while learning. If you are short of money, ask about my Student Finance Plan. Now added Training in Electric Refrigeration. We are also equipped to train those who qualify under G. I. Bill. We also have facilities for men with physical disabilities whether due to war or other causes. Fill in and mail coupon for details.

**SEND COUPON FOR FULL DETAILS**

B. W. COOKE, Dir., Radio-Electronics Div.  
COYNE ELECTRICAL SCHOOL  
500 S. Paulina St., Dept. 17-1K, Chicago 12, Ill.

Send Big Free Book; also details about Coyne Part-Time Employment and Student Finance Plan.

Send G. I. Bulletin  Physical Disability

NAME.....AGE.....

ADDRESS.....

CITY.....STATE.....

bumper feet, and out through the holes in the back.

The smallest available parts were used throughout. As a result, the cabinet occupies about the same table space as the "bug" which it replaced. The dimensions of the cabinet are 6 1/2 inches long by 3 3/8 inches wide by 5 1/4 inches high.

The few adjustments of the control switch mechanism may be reached conveniently by unscrewing the four bumper feet which secure the bottom of the cabinet.

### Adjustment

The adjustment of the key comprises setting potentiometers  $R_2$  and  $R_3$  for the correct, or desired, dot and dash lengths. To insure the correct mark-to-space ratios of 1 for dots and 3 for dashes, the best method is to connect a volt-ohmmeter across the keying terminals. Switch the meter to the "ohms" scale. Set the speed control at about 25 words per minute. Then hold the control switch in the dot position and adjust  $R_2$  until the meter reads exactly half-scale on any "volts" range. Now hold the control switch in the dash position and adjust  $R_3$  until a deflection of 3/4 of full scale is obtained. No further adjustment of  $R_2$  and  $R_3$  will be required as the mark-to-space ratios will remain substantially constant for all settings of the speed control. The relays should be set for a minimum space between contacts and for very light spring tension. Also, there should be at least 1/64 inch space between the relay pole piece and the armature when the relay coil is energized.

The nominal speed of transmission may be determined by counting the number of dots per second and multiplying by 2.5 or by multiplying the number of dashes per second by 5. The speed control may thus be calibrated directly in words per minute as is shown in the photograph. This nominal speed is attained when the operator properly executes the spaces between letters and between dots and dashes.

### Modifications

It seems desirable to indicate a few modifications which appear feasible, though not confirmed experimentally. For example, the plate of  $V_{1A}$  might be coupled to the grid of a transmitter keyer tube which is normally biased beyond cut-off. The voltage at the plate of  $V_{1A}$  is of approximately rectangular waveform in accordance with the code signals being transmitted, with about 45 volts difference between maximum and minimum amplitude. The coupling circuit should include a blocking condenser of about 2  $\mu$ fd. and the grid leak of the keyer tube should be at least one megohm. The 45 volt signal from  $V_{1A}$  must be sufficient to drive the grid of the keyer tube above cut-off voltage and thus turn the keyer tube on and off in response to the code signals.

Further reduction in size of the unit may be accomplished by the use of a

## OSCILLOSCOPE FOUNDATION KIT

5-INCH

Consisting of Case, Chassis, two shelves (right & left), tube shield and bracket, front panel, screen window frame, handle, plastic window socket, with 5CP1 Cathode Ray tube.



SPECIAL

**\$18.95**

- 2x2 Tube ..... \$1.00
- Socket for 2x2 Tube ..... .25
- H.V. Condenser .5 M<sup>rd</sup> 2000 V.... 1.95
- KIT, without Cathode Ray tube. 11.95
- 5CP1 Cathode Ray tube only..... 7.40
- Tube shield and bracket only..... 1.98

Highbridge Radio-Television and Appliance Co.

340 CANAL STREET NEW YORK 13, N. Y.

## RESISTORS is Our Business

CARBON INSULATED & WIRE WOUND

IMMEDIATE DELIVERIES  
Any quantities—any makes!

POTENTIOMETERS  
with and without switches

CAPACITORS

paper tubular, oil-filled and mica

TUBES?

Yes, some of them!

LEGRI S. COMPANY

846-850 Amsterdam Avenue

New York 25, N. Y.

Phone: ACademy 2-0018

**NEW TINY POCKET SIZE RADIO!**

Slips in your pocket or purse—wt. only 3 ozs. Complete READY TO PLAY as shown with self-contained phone for personal use. Beautiful black plastic case. Has patented fixed Crystal-Slide Tuning Dial NO TUBES, BATTERIES, OR ELECTRIC PLUG-IN REQUIRED. USUALLY RECEIVES LOCAL BROADCASTS without outside aerial wires.

**GUARANTEED TO WORK** when connected and used according to instructions. Can be used in homes, offices, hotels, cabins, in bed after hours, etc.

SEND ONLY \$1.00 (cash, money order, check) and pay postman \$2.99 plus delivery fees on arrival or send \$3.99 for postpaid delivery. IDEAL GIFT FOR CHILDREN OR ADULTS ALIKE! Get your PA-KETTE RADIO NOW for real enjoyment. (All Foreign Orders \$5.00 U.S. Cash.)

PA-KETTE ELECTRIC CO., Dept. RN-1, Kearney, Nebr.

## RADIO ENGINEERING TELEVISION ELECTRONICS

Courses in every phase of radio and electronics open to high school graduates. Thorough training, modern courses. Enrollments limited. Approved Veteran Training.

VALPARAISO TECHNICAL INSTITUTE  
Dept. RS Valparaiso, Indiana



# POTTER'S BARGAINS

Simplex, Model 312 AC-DC Volt-Ohm-Mil pocket meter.

Ranges: AC-DC Volts, 25/50/125/250 V.  
AC-DC Mills, 50 MA  
Ohms, 100,000

Net \$6.00 less test leads.

807's New in cartons 99c each.

Stellar Speaker Cement, 2 oz. bottle.... 28c  
Polystyrene Coll Dope, 2 oz. bottle..... 28c  
Thinner for above, 2 oz. bottle..... 19c  
Postage extra. Shipping weight 8 oz. each.

## IMMEDIATE DELIVERY

on the following item:

Hytron's famous VHF kit. Assembled... \$11.95  
Same not assembled..... 9.95  
Hytron 75 tube used in VHF kit..... 3.75

Federal Selenium Rectifier, 100 MA. Replaces 117Z6 and 28 other rectifier type tubes. Quantities 1 to 6, \$1.09 each. Write for other types available and quantity prices.

Phono Motors, Gen. Ind. Model LX... \$ 4.08  
Model D-2. 33 1/2 and 78 RPM..... 15.90

We carry a good stock of Amphenol, American Microphones, Chi. Ind. Testing Eqt., Costal Signal Generators, Dayco Tube Testers, Federal Selenium Rectifiers, General Cement Products, Haldorson Transformers, Hytron Radio Tubes and over 50 other nationally known lines. Write for our monthly price lists of available parts and merchandise.

## POTTER RADIO CO.

Dept. RN

1312-14 McGee St. Kansas City 6, Mo.

## GAY-TONE Phonographs by ALSAM

Model T-22—Table Top Electric Phonograph

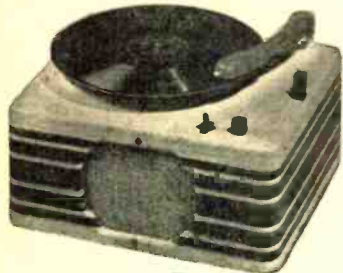

Model P-1012—3 tube portable electric phonograph

or

Model B-101—hand wound battery operated phonograph



Write for prices!

PROMPT DELIVERY

ALSAM PRODUCTS COMPANY  
805 MILWAUKEE AVENUE  
CHICAGO 22, ILL.

January, 1947

6J6 and a 6AL5 miniature tubes as  $V_1$  and  $V_2$ , respectively. No important circuit changes would be necessary except provision for the correct heater voltage for these tubes.

### Operation

The experienced operator will become proficient in the use of the *Electroplex* after one or two hours of casual practice. Numerals, such as 5 and 0 are easiest to send at the start and illustrate well the advantage of the key. A single test word should be selected and transmitted repeatedly at varying speeds until familiarity with the action of the key has been acquired. The basic rhythm established by the timing circuit is quickly picked up by the operator and he is soon transmitting almost perfectly timed code signals with maximum readability and minimum effort.

The beginner should set the speed control for at least ten words per minute even though he may leave much more than normal spacing between letters. As his skill improves, he will increase his speed by closing up the gaps between letters. Both he and his tutor will be pleasantly surprised at the accuracy of his sending and his rapid progress toward higher speeds.

-30-

## Practical Radio Course

(Continued from page 45)

non-linear element in single-electrode input type mixers in superheterodyne receivers designed to operate in the u.h.f. and s.h.f. ranges that are beyond the capabilities of even diode tube mixers. These miniature crystal rectifiers, which measure only 1/4 inch in diameter by 7/8 in. length, are really wartime improvements over the Galena crystal detectors of the 1920 era, and are now made in compact, fixed form. Without them, present-day microwave and radar receivers would be impossible to construct.

Two types of these crystal rectifiers, both illustrated in Fig. 2, are in use. The germanium type constructed as shown at A contains a very small piece (1/8" square and about .025" thick) of crystal material consisting of a carefully controlled mixture of germanium and a small amount of tin. This is soldered to one lead wire. The exposed surface is highly polished so that the point of the springy tungsten wire catwhisker may be readily moved about until a sensitive spot is found, and then the unit is sealed. The theory which has been proposed to explain the operation of a crystal rectifier is too complicated to justify going into detail here. Briefly, the soldering of the crystal to the copper lead wire forms a large contact area, the tungsten contact point a small contact area and since, in certain crystals, electrons have been found to move more readily in one direction across such a junction than the other, rectification occurs. The outside case

## THE MASTERS CHOICE!

### SUPREME MODEL 504B TUBE AND SET TESTER

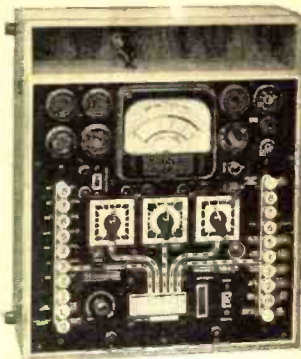

Any craftsman distinguishes himself by the appearance of his tools and equipment. For 19 years SUPREME equipment has identified thousands of successful radio service engineers. SUPREME equipped repair shops distinguish themselves for their professional appearance, dependability, and profitable operation.

One among the complete group of SUPREME radio testers is the Model 504B Tube and Set Tester.

- **METER**— large 4-inch square-face meter, 500 microampere.
- **SPEED**— push-button operated.
- **FLEXIBLE**— simple, yet Universal Floating Filaments feature insure against obsolescence.
- **SIMPLICITY**— roll chart carries full data for tube setting. No roaming test leads when using multi-meter—only push a button.

#### SPECIFICATIONS

DC VOLTS — 1000 Ohms per volt: 0-5-25-100-250-500-1000-2500.  
AC VOLTS — 0-5-10-50-250-1000.  
OUTPUT VOLTS, 0-5-10-50-250-1000.  
OHMMETER, 0-200-2000-20,000 Ohms  
0-2-20 Megohms

#### Condenser Check:

Electrolytics checked on English reading Scale at rated voltages of 25-50-100-200-250-300-450 volts.

#### Battery Test:

Check dry portable "A" and "B" batteries under load.

# SUPREME

SUPREME INSTRUMENTS CORP.

GREENWOOD, MISS.

U. S. A.

"SUPREME BY COMPARISON"



See the complete SUPREME line. Write for new SUPREME catalogue No. 446.



**Sigmon's - WEST VIRGINIA'S**  
LARGEST RADIO SUPPLY HOUSE!

**AMPLIFIER for GUITAR OR PHONO**



- ★ TUBES: 6SJ5, 6J5, 6L6, 5V4G
  - ★ 4 Tubes—Hi Gain
  - ★ Two Microphone or Instrument Inputs
  - ★ Phone Input
  - ★ 6½ Watts—Beam Power
  - ★ Solid Wood Cabinet
  - ★ Aeroplane Cloth Covered
  - ★ Tone Control
  - ★ Heavy Duty 8" Speaker
  - ★ Complete with Tubes
- Complete with Tubes—List \$59.50 **Your Cost \$37.00**

VMI BRUSH CONTROL MIKE—Net \$10.40  
MM TURNER CONTACT MIKE—Net \$ 9.45

**PHONO AMPLIFIER**

3 Tube AC-DC  
Uses: 50L6, 35Z5, 12SR7,  
and 450 ohm speaker  
Net \$5.97



FOR LATEST CATALOG WRITE TO...

**Sigmon's**  
RADIO SUPPLY  
CHARLESTON, W. VA.

**Carry 3000 RADIO FACTS IN YOUR POCKET!**



**RADIOMAN'S HANDBOOK**

Helps You On the Job!

The handiest radio reference book on the market... a library of 3,000 facts, wiring diagrams, formulas, charts, tables, rules—condensed into one pocket-size 4½" x 7" volume. Take it with you on the job—have the answers to daily problems always on hand. Saves time—helps you earn more. Flexible leatherette cover withstands hard usage. Get this book on free trial now!

**GET THIS BOOK FREE!**

TRY IT ON THE JOB—see how often you refer to it—how much time it saves you. Then, if you are not satisfied, return it to us. If you keep the book, AFTER 7 days, you pay only \$3.25.

Educational Book Publishing Division  
**COYNE ELECTRICAL SCHOOL**  
500 S. Paulina Street, Dept. 17-T3, Chicago 12, Ill.

**FREE TRIAL COUPON**

Educational Book Publishing Division  
**COYNE ELECTRICAL SCHOOL, Dept. 17-T3,**  
500 S. Paulina Street, Chicago 12, Ill.

Please send Radioman's Handbook on 7 days FREE TRIAL. If satisfied after 7 days, I will pay you \$3.25—if not, I will return book to you.

Name \_\_\_\_\_ Age \_\_\_\_\_  
Address \_\_\_\_\_  
City \_\_\_\_\_ Zone \_\_\_\_\_ State \_\_\_\_\_

CHECK here if you want to pay postman \$3.25 on delivery. Same 7 days' trial arrangement and money-back guarantee.

is marked "plus" and "minus" to indicate that when the side marked "plus" is connected to the positive terminal maximum current will flow. The tungsten wire is at the end marked "plus."

The germanium crystal rectifier is rated for operation up to 100 mc. but it can be used on somewhat higher frequency. Its cathode-to-anode capacitance is only 3  $\mu\text{fd.}$ , so it is suited for use in FM and television receivers which have high intermediate frequencies. For operation into low-resistance loads, this rectifier is said to be superior to vacuum tube diodes.

The silicon type, constructed as shown at B, employs a silicon crystal and a longer tungsten wire catwhisker. The silicon type crystal rectifier will operate satisfactorily at higher frequencies than will the germanium type, but it must be operated at lower current and voltage levels. One unit (Sylvania No. 1N21B) is recommended for 3000 mc. operation. Another (Sylvania No. 1N23B) is recommended for 10,000 mc. operation. Still another (Sylvania No. 1N26) is designed for 25,000 mc. operation.

Both the germanium and the silicon type crystal rectifiers shown in Fig. 2 are very rugged mechanically.

**Operation of Crystal Rectifiers as Mixers**

The treatment that has been presented here for the diode tube as a mixer applies in part to crystal mixers also. The circuit arrangement used for them, see Fig. 3, is also similar to that employed for the diode mixer, the crystal unit being substituted for the diode.

Like the diode mixer, the crystal mixer will convert in both directions, even though the ratio of forward current to back current may be as high as 1000 to 1 in some types. This action is minimized by suitably plating the crystal element before it is embedded in its fusible alloy mounting.

Because no frequency-conversion gain is obtained with them (actually a conversion loss of approximately 10 db. is sustained when they are employed), crystal mixers are widely used only in those receivers designed for operation on the u.h.f. and s.h.f.

ranges where conventional forms of vacuum tube mixers and frequency converters would fail to operate satisfactorily. For this type of service they have no competition at the present time.

Due mainly to the fact that the capacitance existing across the actual crystal element acts as a bypass to the high-frequency voltage which would normally appear across the contact junction, the conversion efficiency decreases with increase in frequency. In the compact, well-designed, completely-enclosed cartridge type units now available (see Fig. 2), the internal structure has been designed to produce an exceedingly low amount of shunt capacitance. For example, the cathode-to-anode capacitance of the Sylvania 1N34 germanium crystal shown in Fig. 2A is only 3  $\mu\text{fd.}$ . Because its capacitance is very low, the crystal rectifier's electrical time constant is very small.

Also, the resonance frequency of the crystal rectifier unit must be kept well above the highest operating frequency that will exist in the mixer circuit, for erratic operation results when the series resonance frequency of the crystal unit is approached. The series resonance frequency is made high by proper design that reduces the inductance of the contact lead and the capacitance across the crystal element.

Crystal rectifiers are not as uniform in operating characteristics as are diodes. Also, when used as mixers they must be protected from strong signals or r.f. fields that will set up sufficiently strong currents to damage the junction between the contact and the crystal. Consequently, they are unable to handle extremely high signal voltages and they must be protected from them, otherwise burning of the sharp catwhisker contact point will result.

An important advantage of well-designed crystal mixers besides their ability to operate at very high frequencies, is that they have a high signal-to-noise-ratio. Also, the fact that either or both sides may be operated above ground by any reasonable potential is a distinct advantage over the tube diode for many uses. Then

Fig. 3. Basic circuit for a frequency-converter stage in which a crystal rectifier is employed as the mixer. This arrangement is widely used in u.h.f. and s.h.f. receivers.

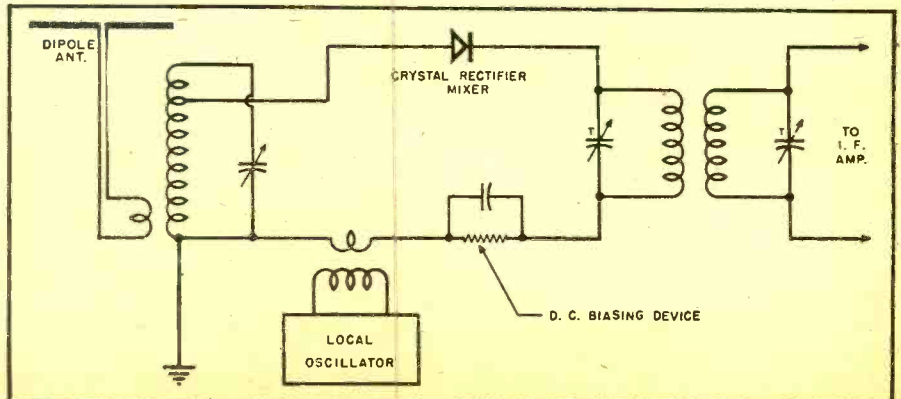



too, they require no heater or plate supply, so the possibility of hum is reduced.

The tabulation (Table 1) has been prepared to classify the various types of mixers and converters discussed in the last seven articles of this series, and to summarize pertinent information concerning the operation of each type. Also, the particular article of this series in which each type was discussed, and the illustrations in that article which refer particularly to it, are listed for convenient back-reference in the right-hand column.

This concludes our discussion of frequency conversion. The intermediate-frequency amplifier will be studied next.

(To be continued)

### Crystal Diode Applications

(Continued from page 43)

screws to hold the disc in place. Drill a  $\frac{3}{8}$ " hole in the other end of the tube shell and insert a grommet.

In the disc, which can be made of phenolic, polystyrene, or lucite, a banana plug is mounted for a probe. A 4-40 bolt is mounted off center on the disc to serve as a ground for the crystal diode, the condensers, and resistor. The probe in Fig. 1 was to be used at frequencies above 100 kc. so two 100 micromicrofarad Ceramicon condensers were used.

If audio frequencies are to be measured, a larger condenser would be necessary, as the effective impedance of the diode is lower than a tube diode. If this is kept in mind, the probe can prove quite useful. It can be plugged into the d.c. voltage jacks of your volt-ohm-milliammeter and will read peak a.c. volts. Provided it does not seriously load a circuit, it will measure a.c. voltages up to 100 megacycles.

With the 100 micromicrofarad condensers eliminated and a 1 microfarad condenser substituted, the meter will read audio frequencies accurately. The average volt-ohm-milliammeter uses a copper oxide rectifier for its a.c. ranges, which does not accurately indicate voltages above several thousand cycles. The crystal probe converts a volt-ohm-milliammeter into an audio output meter which is independent of frequencies. Remembering that the input impedance is in the order of several hundred thousand ohms, the readings would be reasonably accurate.

The crystal diode, plus a microam-

Fig. 4. Detector and a.v.c. circuit designed around the 1N34 crystal diode. This circuit differs from that of Fig. 2 in that higher output voltage is obtained.

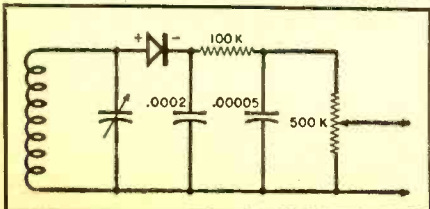

January, 1947

LUKKO Offers—

## TWO SPECIALS!

### Electrolytic Filter CONDENSER

89¢ each



- Can be used as single 20 Mfd. at 450V, 15 Mfd. at 450V or 35 Mfd. at 450V
- Hermetically sealed
- Manufactured Oct. 15, 1946
- Complete with mounting nut
- Diameter of can— $1\frac{3}{8}$ "
- Diameter of threaded stud— $\frac{1}{8}$ "
- Height of can— $\frac{1}{4}$ "

- 20 Mfd. & 15 Mfd. at 450 WV
- Common positive

### 5" PM SPEAKER

- 7 oz. Alnico 3 Magnet
- Heavy Duty cone and dust cap
- A good replacement for auto radios
- Designed and used in Navy marine receivers

\$195 each



Write today for our big sound catalog and get on our mailing list. We carry a complete line of radio parts, equipment and accessories.

### THE LUKKO SALES CORPORATION

5024 Irving Park Road

Chicago 41, Illinois

Established 1924

## NEW SOLDERING GUN with adjustable tip FOR TOUGH JOBS

HEATS IN 5 SECONDS



### TIP ADVANTAGES

STAYS TINNED—NO BURNING



SEE WHERE YOU SOLDER



WORK AT CLOSE QUARTERS



High heat produced in loop type tip by induction principle gives speed and flexibility to soldering with the new gun type Speed Iron. Ideal for intermittent operation on maintenance and radio service work.

Available at your radio parts distributor or write direct for descriptive bulletin.

- ★ 115 Volt 60 Cycle 100 Watts
- ★ Built-In Light Weight Transformer
- ★ Intermittent Operation With Trigger Switch
- ★ Can't Overheat or Burn Out
- ★ Tip Heats And Cools Fast
- ★ Impact Resisting Case
- ★ Soldering Heat In 5 Seconds

810 PACKER STREET

WELLER MFG. CO. • Easton, Pa.

Export Dept.—25 Warren Street, New York 7, N. Y.

In Canada—Atlas Radio Corp., Ltd., 560 King Street N. W., Toronto, Ont.



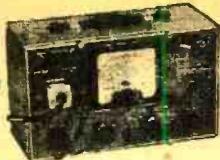

NOW  
IN  
STOCK!

ORDER  
TODAY!

**McMURDO-SILVER "VOMAX"**

Net Price \$59.85  
Model 904 Capacitance-Resistance Bridge \$49.90  
Model 905 "Sparx" signal tracer \$39.90

LEADING STANDARD BRANDS:  
**12" PM SPEAKERS**  
with New Alnico 5 Magnet  
Capable of handling 12 watts output  
**SPECIAL—\$10.50**

EASTERN 14 Watt Amplifier \$38.22  
RADIO LINE FILTER—SPECIAL \$ 4.75  
5" PM SPEAKERS—alnico 5 magnet \$ 1.65

MANY TEST INSTRUMENTS  
IN STOCK!  
LOOK AT THESE VALUES!

SIMPSON 215 volt-ohm-milliammeter \$32.50  
SIMPSON 260 volt-ohm-milliammeter \$38.95  
SUPREME 542-B volt-ohm-milliammeter \$23.65  
SUPREME 599A tube & set tester \$62.50  
SUPREME 576 oscillator \$68.95  
SUPREME 504B tube and set tester \$89.50  
SUPREME 562 Audalyzer \$127.00  
ELECTRONIC DESIGNS "Pro-Vac" \$59.50  
SPECO signal tracer, with probe \$44.95  
TRIPLETT 666-H volt-ohm-mil. \$20.00  
TRIPLETT 625-N volt-ohm-mil. \$45.00  
TRIPLETT 2432 signal generator \$88.50  
TRIPLETT 2405 volt-ohm-milliammeter \$56.75  
TRIPLETT 3212 counter tube tester \$63.50  
RADIO CITY 322 tube tester \$41.50  
RADIO CITY 461AP volt-ohm-mil. \$43.50  
RADIO CITY 802-N tube and set tester \$59.50  
WATERMAN 2" oscilloscope \$66.00  
DUMONT 274—5" oscilloscope \$99.50  
DUMONT 164-E 3" oscilloscope \$105.00  
DUMONT 208-B 5" oscilloscope \$235.00  
Also, TUBES • AMPLIFIERS • PHONOS

SEND FOR NEW FREE CATALOG!

SCENIC RADIO & ELECTRONICS CO.  
53 PARK PLACE • Dept. J • N. Y. 7, N. Y.



now you can

**SEE and HEAR** the signal  
with the new **CA-12**

*Signal Tracer*



**FEATURING**

Simple Operation...  
only one connecting  
cable... No tuning Con-  
trols. A new Superior  
Instrument Product.  
Complete with Probe,  
Test Leads, Batteries  
and Instructions.

Price **34.85**

We handle a complete line of Radio Parts and Tubes. Write for the latest LIFETIME BULLETIN just off the press. Thousands of money-savers in parts, supplies, equipment. Address

**Lifetime**  
SOUND EQUIP. CO., Dept. 54  
911-913 JEFFERSON AVE., TOLEDO 2, OHIO

meter and a dipole antenna, constitutes a simple field strength meter for measuring field strength and antenna patterns.

Substitute a pickup coil for the antenna and it becomes a handy resonance indicator for u.h.f. oscillators or transmitters. Being inexpensive and requiring no power, it would be very useful in portable or mobile equipment—for instance, in a portable transmitter-receiver, the diode could be used as follows: Mixer or first detector in the receiver; second detector in the receiver; a.v.c. rectifier in the receiver; rectifier on a.f. modulation meter in transmitter; rectifier in r.f. tuning meter on transmitter.

These five functions would normally have to be done with five diode tubes and, so, in the case where power is at a premium, the crystal would prove quite a battery saver.

In pulsed circuits, the crystal diode is also useful. It is here that we may make use of the fact that it provides a diode, together with its own load resistor. Useful, also, is its low forward resistance. For instance, if we have a piece of gear which is keyed off with a positive pulse but whose operation is erratic if the pulsing source contains some negative overshoots, then a crystal diode connected across this pulsed input will short out any negative going overshoots but will easily pass all positive pulses. Its back resistance, in the order of several hundred thousand ohms, constitutes the grid resistor of the input tube and, thereby, saves a part. It may, likewise, be used in d.c. restoration circuits whose resistance is not over several hundred thousand ohms.

A multivibrator may be improved by

General Electric's recently completed 130-foot steel tower located in the Helderberg mountains 12 miles from Schenectady. The structure at the top of the tower contains antennas, transmitting and receiving apparatus for the company's experimental microwave, two-way radio relay network to operate between New York City and Schenectady as a carrier for television and FM radio programs, facsimile and business machine circuits. Other such relay towers are now under construction.



**OUR KNOW HOW**

IS THE ANSWER TO YOUR  
**INSTRUMENT REPAIR PROBLEMS**

INSTRUMENT SERVICE technicians are specialists in METER and TEST EQUIPMENT repairs.

You will get prompt and guaranteed repair service on all makes of METERS — MULTI-METERS — SIGNAL GENERATORS — VACUUM TUBE VOLT-METERS — TUBE CHECKERS.

ALL CALIBRATIONS CHECKED AGAINST PRECISION STANDARDS.

Inquiries solicited.



INSTRUMENT SERVICE Co.

2515 AMSTERDAM AVENUE  
NEW YORK 55, N. Y.

**Deluxe Radio  
Parts Assortment**

**\$500**  
PER KIT

Contents Include All This:

- THROAT MIKE
- MOTOR OR DYNAMOTOR
- TRANSFORMERS
- SWITCH BOX
- SWITCHES
- KNOBS
- RESISTORS
- CHOKES
- COIL FORMS
- TUBE SOCKETS
- PILOT LITE W/BULB
- CONTACT POINTS
- INSULATORS
- FLEXIBLE SHAFTS
- TERMINAL BOARDS
- CONDENSERS
- RELAYS
- FUSE HOLDER

AND MISC. SMALL PARTS

Shipping Weight 20 lbs.

SEND ONLY \$5.00 for each kit wanted.

No C.O.D. ORDERS FILLED

ALL SHIPMENTS BY RAILWAY EXPRESS  
CHARGES COLLECT

**GEORGE BROOKS & ASSOCIATES**

220 SOUTH HALSTED STREET CHICAGO 6, ILLINOIS

**RADIO ENGINEERING!**

EX-SERVICE MEN can complete work here in shortest possible time. Courses also in Civil, Electrical, Mechanical, Chemical, Aeronautical Engineering, Business Administration, Accounting, Secretarial, Science, 63rd year. Enter Jan., Mar., June, Sept. School now filled to capacity. No applications can be accepted until further notice.

DEGREE IN  
27 MONTHS

TRI-STATE COLLEGE 1617 College Ave.  
ANGOLA, INDIANA

**ROTA-BASE**

NEW HANDY LAB. DIAL. Simply turn the movable dial to the tube number desired on the ROTA-BASE and complete, correct connections are instantly indicated on the "prong" diagram. Filament, grid, plate, cathode, etc., to more than 300 tube types are given. No more valuable time lost on lengthy reading or thumbing of pages. ROTA-BASE actually gives a "prong" picture of the connections. PRICE NOW ONLY \$1.00. Postage prepaid or sent C.O.D. plus postage. Money back if not delightfully pleased.

REED MFG. CO. 124 W. 4th St.  
Los Angeles 13, Calif.

**PEN-OSCIL-LITE**

Extremely convenient test oscillator for all radio servicing; alignment • Small as a pen • Self powered • Range from 700 cycles audio to over 800 megacycles u.h.f. • Output from zero to 125 v. • Used by Signal Corps • Write for information.

GENERAL TEST EQUIPMENT CO.

38 Argyle Buffalo 9, N. Y.



# WAR SURPLUS! RADIO PARTS

## POWER SUPPLY KIT

A Power Supply Kit for 110/220 V. 60 Cycle. A.C. complete with a power line filter. Output from filter: 270 V.D.C. @ 150 Ma. load. Filament windings: 6.4 V. @ 4 A. & 5 V. @ 3 A.

- PARTS LIST**
- 1—Power Transformer
  - 1—Line Filter
  - 1—Dual Choke
  - 1—Condenser Bank
  - 1—Octal Tube Socket
  - 1—Toggle Switch
  - 1—Bleeder Resistor and Hook-up Wire

**Special Per Kit**  
**\$10.00**

## AMPLIFIER ASSEMBLY (No. 157 P-4)

- Consisting of the following items:
- 8 Relays, G.E. #CR2791-B109P36. 1 Amp. Silver Contacts. DPDT, 2 contacts normally closed 8000 ohms, closes at 10 Ma.
  - 4 Transformers—Signal input—pri. 115 V., #1 (150 V., pri. inductance at 50 Ma. D.C. 0.28 H, turns ratio pri. to each sec. 1 to 10, freq. response flat from 20 to 6000 CPS.
  - 1 Transformer—Power—pri. 115 V., 400 CPS; sec. #1 630 V., with CT; sec. #2 150 V.
  - 11 Octal Tube Sockets, snap ring type mfg.
  - 8 Dual Capacitors .1 x .1 mfd., 600 V. D.C., oil filled, bathtub type.
  - 4 Capacitors, 1 mfd., 1000 V. D.C., G.E. Pyronal.
  - 4 Capacitors, .25 x .25 mfd., 1000 V. D.C., G.E. Pyronal.

**SPECIAL \$6.00**

## BEGINNER'S RADIO PARTS KIT

Sixty pieces of good parts plus a punched radio chassis.

- 1—5x3 1/2x3 chassis punched for three tube sockets.
- 1—10,000 ohm volume control.
- 1—pr. 1—5 pr. and 1—octal tube sockets.
- 1—multi-tap wafer switch.
- 1—air condenser.
- 2—matched knobs.
- 1—phone-plug.
- 1—roll stranded hookup wire, insulated.
- 1—spool solid hookup wire, bare.
- 3—small coil forms.
- 2—2.5 mh. RF chokes.
- 1—iron-core variable inductor.
- 2—.05 mfd. bypass condensers.
- 1—.25 mfd. bypass condenser.
- 15—assorted 1/2 watt resistors.
- 10—assorted 1 watt resistors.
- 15—assorted mica condensers.

**At Least 61 Pieces All For \$3.00**

## RELAYS

A set of five very useful relays for the price of one of them.

- 1—SPST Myacalex insulated antenna relay, 115 V.A.C.
- 1—DPDT power relay, 115 V.A.C.
- 1—DPDT power relay, operates on 28 V.D.C.
- 1—DPDT power relay, operates on 10 Ma. D.C.
- 1—SPDT timing relay, operates on 24 V.D.C.

**SPECIAL ALL FOR \$3.00**

A bank of 8—8000 ohm DPDT relays, closing at 10 Ma. D.C.

## FOR 8 RELAYS

**\$4.00**

## RESISTORS

- 100 Assd. 1/2 Watt Carbon Resistors.....\$2.00
- 100 Assd. 1 Watt Carbon Resistors..... 3.00
- 50 Assd. 2 Watt Carbon Resistors..... 2.00

Two meter vertical antenna complete with base and Type "N" coax. connectors. **SPECIAL \$1.00**

15 Assorted Volume Controls, 1000 r. to .5 meg. **SPECIAL \$3.00**

## CONDENSERS

- 5 Assorted oil, paper, and electrolytic filter condensers with voltage ratings up to 600 V. **SPECIAL \$3.00**
- 20 assorted oil and paper bypass condensers, .1 mfd. and up, and up to 600 W.V. .... **SPECIAL \$3.00**
- 50 assorted bypass condensers .001 mfd. to .5 mfd. up to 600 W.V. .... **SPECIAL \$3.00**
- 50 assorted mica condensers..... **SPECIAL \$2.00**

All items listed above are subject to prior sale. Terms cash with order F.O.B. Chicago, Ill. Remit only exact amount of purchase.

# IRVING JOSEPH

220 S. Halsted St., Chicago 6, Ill.

Buyer and Distributor of Surplus Stocks

# Within the INDUSTRY

**LESLIE G. THOMAS** has recently been elected vice-president in charge of manufacturing of *Solar Manufacturing Corporation*, of New York.



Mr. Thomas will have complete supervision of production at *Solar's* plants in Chicago, Bayonne and North

Bergen, New Jersey. He has had extensive experience in the various manufacturing phases of the radio parts industry and until recently served as vice-president and works manager of *International Resistance Company* of Philadelphia.

**NORMAN A. KOETKE** has been added to the executive staff of the *National Electronic Distributors Association's* national office.

Mr. Koetke, who brings to the association a wide range of experience, will assist the executive secretary, Louis B. Calamaras.

The addition of the new staff member will permit an increase in the services rendered by the Association to its members. A monthly publication will be prepared for members to supplement the regular bulletin service now offered. Mr. Koetke's presence in the national office will release Mr. Calamaras and permit him to attend chapter meetings, visit manufacturers and appear before representative groups.

**JOSEPH L. COLLINS** has been appointed chief engineer of the *Aerovox Corporation* of New Bedford, Massachusetts.

Mr. Collins previously headed the Electrolytic Engineering Division and prior to that time was in charge of Electrolytic Engineering, *Sprague Electric Company*.

**SAMUEL LUBIN**, formerly a member of the new development section of the



Technical Standards Division of REA, has recently joined the field engineering staff of *Sprague Electric Company* of North Adams, Massachusetts.

Mr. Lubin will be stationed in Washington, D. C. in charge of contacts with all government agencies and laboratories, including the Navy Department, Signal and Air Corps and the Departments of the Interior, Commerce and Agriculture.

During the war Mr. Lubin served as transition engineer of the Radio Research Laboratory at Harvard University. From 1932 to 1939 he was managing director of *International Radio Ltd.* of Tel Aviv, Palestine, representing American firms in North Africa and the Near East.

Mr. Lubin received his engineering training at Northwestern School of Engineering, George Washington University, Washington, D. C.

**DON E. CORSON**, well-known in the radio parts field, has recently been appointed to the post of manager of the Special Products Division of *Solar Manufacturing Corporation*.

Before joining *Solar*, Mr. Corson was associated with *Aerovox Corporation* in the capacity of sales manager of the Power Division and *Cornell-Dubilier Electric Corp.* where he served as sales manager of the Power Factor Division.

Mr. Corson is a graduate of M.I.T. and is a member of the American Institute of Electrical Engineers.

**RALPH S. MERKLE** is the new manager of parts sales for *Sylvania Electric Products Inc.* in



which position he will direct the sales of small metal and mica parts, wire and welded wire products manufactured in the company's plants at Emporium and

Warren, Pa. and Jamestown, New York.

Mr. Merkle joined the staff of *Sylvania* in August of 1929 and has served as sales engineer, sales representative, commercial engineer and in the customer technical service department.

He was granted a leave of absence from June, 1942 until July 1, 1946 during which time he served in the Signal Corps and assisted in the development of the Joint Army-Navy electron tube program which resulted in the JAN specifications. He was discharged with the rank of major.

**VICTOR E. OLSON** has been appointed sales manager of the Receiver Sales Department of *Allen B. DuMont Laboratories, Inc.*

Before assuming his new post with *DuMont*, Mr. Olson was Eastern Sales Manager of the *Meissner Manufacturing Division* of *Maguire Industries*, in charge of dealer organization and sales promotion of their radio-phonograph combinations.

In his new position Mr. Olson will be



connecting a diode from grid to ground on one or both of the multivibrator tubes. During the flip over period, one of the multivibrator tube's grids acts as a diode when it is driven positive. This grid, however, does not have a very low resistance in such a case, so it may be driven quite a bit positive, giving rise to an unwanted overshoot on the edge of the square-wave. Also, it takes an appreciable time for the coupling condenser to discharge, after this function has taken place. A diode connected from this grid to ground will keep the grid from being driven so far positive and will quickly discharge the coupling condenser which will steepen the square-wave output of the multivibrator and increase its frequency range.

There are a host of other uses for these crystal diodes, the low cost of which makes them practical where a tube and associated power requirements would be impractical. Its frequency response compares favorably with a miniature diode, which will make it as commonplace as the neon bulb in the ham shack. It has many ham applications, such as in noise silencer circuits, crystal detector in a monitor or frequency meter, tuning indicator and in antenna pruning. There will be other uses and it is hoped that this discussion will stimulate your thinking on the subject.

-50-

### For the Record

(Continued from page 8)

know what great brains are cooking up these new servicing plans, but we do know these facts: AM has created a force of nearly 60,000 dependable servicemen-dealers who have been reasonably gainfully employed in keeping the 60,000,000 AM receivers in working order. But servicing AM sets is supposed to be child's play compared to techniques that will be required to service FM and television. If any radio manufacturer or groups of manufacturers plans to develop a large organization to service FM and TV (and they confidently expect these media to be publicly accepted on a large scale) then they had better prepare to employ 100,000 to 150,000 technicians to handle the service which will be required in every city, town and hamlet.

Years ago, when the automobile industry faced a similar problem—they *did* something about it by supplying vital information to local blacksmiths and bicycle repairmen—the forerunners of our modern automotive mechanics.

Mr. and Mrs. Customer, especially farmers and others living in remote areas—many without telephones—are not going to sit around for a couple of weeks waiting for the serviceman to arrive. They would far rather rely on their local serviceman, just as they would their doctor, to be able to call on them promptly—when needed. O. R.

January, 1947

# 4 Points

## TO REMEMBER

### FOR BETTER SOLDERING

**Skillfully designed for versatility in soldering, this rugged pencil iron tackles those big jobs with ease, yet has that light magic touch so necessary in delicate precision soldering.**

*More Points to Remember*

- ... heats in 90 seconds
- ... requires only 20 watts
- ... weighs 3.6 ounces
- ... length 7 inches

*Perfect Balance*

**No. 536** Pyramid Tip, made from Tellurium

**No. 539** Chisel Tip, made from Tellurium

**No. 537** Pencil Tip, made from Elkaloy A, Tip 1/8" dia.

**No. 538** Chisel Tip, made from Elkaloy A, Tip 1/8" dia.



These 4 INTERCHANGEABLE tips give you a point for each particular job.

**UNGAR Electric Tools**

BOX 2255, TERMINAL ANNEX, LOS ANGELES 54, CALIF.

SEE YOUR NEAREST RADIO, HARDWARE OR HOBBY DEALER

# Presenting The New Improved

## JFD REMOTE-O-CABLE REPLACER

Servicemen's  
Net Cost  
**\$64.30**

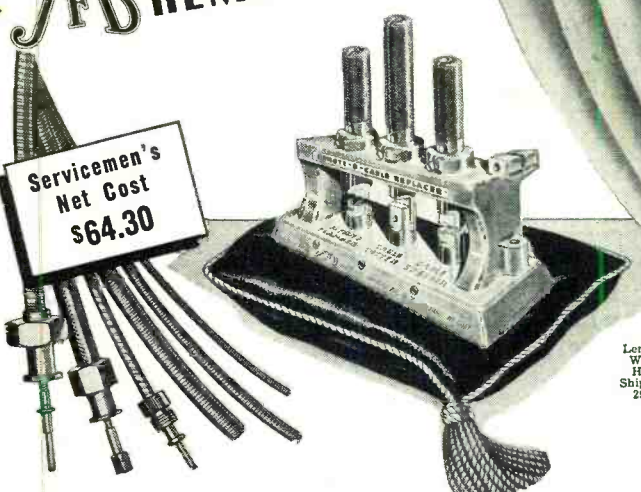

Length 10 1/4 in.  
Width 4 1/4 in.  
Height 13 in.  
Shipping Weight  
28 1/2 Pounds

### The Most Efficient Auto Radio Tuning Cable-Servicing Machine in Use Today!

Completely redesigned to meet MODERN Servicing requirements, the NEW JFD REMOTE-O-CABLE REPLACER is a vital necessity in the workshop of every auto-radio serviceman

- 1 SWEDGES SHAFTING TO PREVENT UNRAVELLING.
- 2 CUTS SHAFTING TO EXACT LENGTH
- 3 REPLACES OLD FITTINGS ON NEW SHAFTING
- 4 CASING GROOVE MAKES CUTTING EASY

J. F. D. MANUFACTURING CO., 1111 FT. HAMILTON PKWAY, BERKIN, N. Y.



## WAR SURPLUS SALES

### RADIO - ELECTRICAL - ELECTRONIC EQUIPMENT - PARTS - SUPPLIES

**SUPERIOR 2 KVA Power Stats:** input 115 volt AC, 50-60 cycle single phase—output voltage range 0-135 volt; maximum rated output current 15 amp available over entire range of output voltage; weight \$29.50 approx. 20 lbs.

**SUPERIOR 2 KVA 3 1/2 KW power stats,** 2 in tandem, each 115 volt AC single phase. Same as the above but twice the input and output voltage. \$54.50

**WESTERN ELECTRIC or SYLVANIA 1-N-21:** 1-N-23 Crystals, 35c each. 3 for \$1.00

**ZENITH-BENDIX or RAWLINS Frequency Meters BC 221** with original crystals; complete with spare tubes and calibration book, each one tested, guaranteed. \$54.50

**WESTON—2" Meter, Model 506—** metal case, 1 1/2 mil. D.C. 2.50

**G.E. 2" Meter, Model 8DW44,** bakelite case; 0 to 1 amp. R.F. 2.50

**Phantom antennas,** each .50

**Crystals 5000 KC complete in holders** 1.95

**Standard rack cabinets heavy gauge steel,** gray crackle finish; panel opening 12.95 19" wide, 27" high.

**PHILCO TANK ANTENNA—**all aluminum, copper weld, dark grey finish; 12 feet long, in 3 sections; weight 10 oz.; base 5/16", dia. tip 1/8". Very special. \$0.98

Many other interesting items

Prompt Delivery  
25% deposit required on each order  
Shipped F.O.B. New York  
Minimum Order \$2.00

## MICHAEL STAHL, INC.

39 RNJ VESEY ST.

Tel. COrtland 7-5980 New York 7, N. Y.

NEW—JUST RELEASED!



### SOLAR Model CF-1-60 EXAM-ETER

With Exclusive Patented Solar "Quick-Check" Circuit. A sturdy, reliable instrument designed to simplify and speed up electronic servicing.

- QUALITY CHECKING OF CAPACITORS UNDER ACTUAL OPERATING CONDITIONS.
- CAPACITANCE—10 mmf. to 2000 mf. mfd.
- POWER FACTOR—0 to 55 percent.
- LEAKAGE CURRENT—at voltages up to 550 volts.
- INSULATION RESISTANCE—3 to 10,000 megs.
- RESISTANCE—100 ohms to 7.5 megs.
- DC Vacuum Tube V.M. —0-550 volts.
- AC Vacuum Tube V.M. —10 to 50 volts.
- Complete with tubes and test leads, ready to operate. \$59.70

### RCP Model 802N COMBINATION TUBE-SET TESTER



Immediate Delivery from Stock.

A complete tube tester and a complete set tester, with only 5 simple switches to operate for both tube and set tester combined.

**RANGES**  
DC V.M. 0/10/50/500/1000 at 1000 ohms per v.  
AC V.M. 0/10/50/500/1000.  
DC M.A. 0/1/10/100/1000 DC Ammeter 0/10.  
Ohmmeter 0/500/5000/1,000,000/10,000,000. Low ohm center.

D.B. Meter—8/15/15 to 29/29 to 49/32 to 55 db.  
Four range output meter—same as AC volts.  
Size: 12 3/4 x 12 3/4 inches. Weight: 13 1/2 lbs. Complete in handsome hardwood case, with test leads, self-contained batteries, ready to operate. Net. \$59.50

**ADSON RADIO CO.**  
221 FULTON ST., NEW YORK 7, N. Y.

responsible for the sales of DuMont television receivers.

\* \* \*

**MILTON E. LAUER** has been named to the newly created post of Product Manager of the Radio Tube Division, Sylvania Electric Products Inc.



Mr. Lauer will be responsible for close coordination between manufacturing, engineering, sales and administrative departments with respect to all products of the Radio Tube Division.

He has been associated with Sylvania since 1933 and has served in various capacities in the production department of the company. From September, 1944 until June, 1945 he served as Chief, Production Scheduling and Distribution Unit, Electron Tube Section, Radio and Radar Branch of WPB.

\* \* \*

**WILLIAM C. LEWIS**, former chief of the Stromberg-Carlson government contract terminations department, has been promoted to the position of assistant sales manager.

A veteran of 17 years' service with the company, Mr. Lewis will assume many of the duties of the Rochester radio, telephone and sound equipment sales executives in order to free them for field activities.

\* \* \*

**MARVIN J. ALEF** has been elected to the post of president and general manager of Aviola Radio Corporation of Phoenix, Arizona, according to a recent announcement made by the Board of Directors.



Mr. Alef is well known in radio, manufacturing, and

merchandising circles having held executive positions with Detrola Radio Corporation, Lee Anderson Advertising Company, Willys-Overland Company and Warren City Manufacturing Company before joining Aviola.

Aviola manufactures a line of radios, record players and phono-combinations in addition to aluminum window frames and sashes.

\* \* \*

**GEORGE C. CONNOR** has recently been named general sales manager of the Electronics Division of Sylvania Electric Products Inc.



Mr. Connor, who has been associated with the company since 1934, will be responsible for the merchandising and

sale of electronic products, including special tubes, measurement controls, strobotrons, thyratrons, photo tubes and custom-built precision equipment.



## Radio Servicemen

### FREE CATALOG

Your Buyer's Guide for New Test Instruments

Contains nationally-known volt-ohm milliammeters, tube testers, signal generators, set analyzers, oscilloscopes, etc., all available on Wards Convenient Monthly Payment Plan. This first post-war issue of the Airline Electronic Equipment Catalog also features Amateur communications receivers and Wards Airline Sound Systems. Send for your free copy today.

Mail this coupon to  
MONTGOMERY WARD, Chicago, Ill.  
Please send your free Catalog of Airline Electronic Equipment.

Name \_\_\_\_\_  
(Please PRINT Plainly)

Address \_\_\_\_\_

City \_\_\_\_\_ State \_\_\_\_\_





**Resco Sound Systems**  
No Better Quality  
No Lower Prices

**A Resco Value Scoop!**  
**RCA OUTDOOR SPEAKER**

Designed and Engineered by RCA for the U. S. Navy for use on warships



**Specifications**  
Magnet weight—7 lbs.  
Rated Wattage — 30  
watts, Voice Coil—8  
ohms impedance. Com-  
plete with output trans-  
former for multiple use.

**6 for \$84** **\$15 Each**

**MODEL PA-1 READY TO INSTALL**

Completely assembled system, ready to hook up. Includes high fidelity 14-watt amplifier; 12" PM speaker; crystal microphone; wall baffle; 25 foot speaker cable and connectors.

**52<sup>95</sup>**

Other Sound Systems Also Available... Write for Full Details.

**Radio Electric**  
SERVICE CO. OF PENNA., INC.

7TH AND ARCH STREETS, PHILA. 6, PENNA.  
Branches: 5133 Market St. and 3145 N. Broad St. in Phila.  
Also in Wilmington, Del., Easton, Pa., Allentown, Pa., Camden, N. J.



**Clippard**  
**ELECTRONIC VOLT-  
OHMMETER, MODEL 406**  
Immediate Delivery!

We invite comparison of this instrument with any at any price for appearance, ruggedness, accuracy, stability. 0-1 to 1,000 volts U.H.F.. A.C., D.C. 0-1,000 megohms. Pen-type dual-diode A.C. probe. No extras to buy. Send for details or order today.

**\$89<sup>50</sup> NET**

From Jobber or F.O.B. Cinti.

**CLIPPARD INSTRUMENT LAB., INC.**  
1125 Bank St., Dept. 3, Cincinnati 14, Ohio

During the early part of the war, Mr. Connor was liaison agent between *Sylvania Electric* and the government on the engineering development of radio and radar products, and in 1943 he established the company's West Coast sales office.

\* \* \*

**CARL W. MULLER** has assumed his new duties as vice-president and general manager of *Sorensen & Co., Inc.* of Stamford, Conn., manufacturers of precision voltage regulator equipment and experimental and special electronic apparatus.



Mr. Muller received his degree in mechanical engineering at St. Mary's University. He served with the AAF from 1927 to 1939. During the war, Mr. Muller was stationed at Wright Field as project engineer on cold weather instruments for aircraft power plants. He was chiefly responsible for designing airplane instruments to withstand below zero temperatures.

He holds various patents on navigation instruments developed and used during the war in connection with Link trainers. He received the Civilian Meritorious Award for his development work.

\* \* \*

**ERNEST L. WARD** has been named vice-president of *Sprague Electric Company* of North Adams, Massachusetts.

Mr. Ward, who joined the executive staff of *Sprague* in 1946, will include among his new duties the coordination of the manufacturing and service activities of the company.

Prior to joining *Sprague* Mr. Ward had extensive experience in the investment banking field where he specialized in industrial operations and organization.

\* \* \*

**LEE BUNTING** has been named sales manager of *Garrard Sales Corporation* of New York, American agents for the *Garrard Automatic Record Changer*.



Before entering the selling field, Mr. Bunting was a radio engineer. His previous affiliations include, serving as project and commercial engineer of *Meissner Manufacturing Company*, Mt. Carmel, Illinois and sales manager of the Record Changer Division of *Maguire Industries, Inc.* of Bridgeport, Connecticut.

\* \* \*

**DON A. DAVIS**, for several years chief engineering representative for the *Cannon Electric Development Company* of Los Angeles, has been appointed sales manager of the company.

Mr. Davis replaces William V. Brainard who resigned to form his own

**The BUY of a LIFETIME!**

U. S. SIGNAL CORPS

**5 Meter**  
**SHORT WAVE**  
**TRANSMITTERS**  
(72.2 Mc.)

only **\$3.49**

Xmtr & Tube only  
Less mike, batteries  
and antenna.

One 1½ volt dry cell and 67½ volts of B operates it. Just attach di-pole, key or mike, connect the batteries and it's ready to use. Signal Corps spec wired with silver wire silver-mica condensers, and precision resistors. Highly stable circuit with Lo-Loss silver inductance. (Adjustable paddler.) Schematic supplied.

- Converts to walkie-talkie and Ham bands.
- Weighs less than a pound.
- Shipped by express only. No C.O.D.s.
- No Parcel Post.
- A sacrifice at only \$3.49. Postal or express money order or certified check.

**NEWARK SURPLUS MATERIALS CO.**

324 Plane St. Dept. N. Newark 2, N. J.  
Send stamp for our giant Catalog

**REPAIRMEN AND MANUFACTURERS GUARANTEED! RADIO TUBES!**

Miniature 3 Way Portable Kits 1R5, 1T4, 1S5, 3Q4, 117Z3.

Miniature 12 Volt Kits  
12BE6 Replacing 12SA7  
12BA6 Replacing 12SK7  
12AT6 Replacing 12SQ7  
35W4 Replacing 35Z5  
50B5 Replacing 50L6

G.T. 12 Volt Kits  
12SA7 12SK7 12SF7 12A6 35Z5

LARGE QUANTITY OF FOLLOWING TYPES  
3Q5 6SK7 6K6 6F6 6G6 6P5 6SJ7 32L7

Send list of requirements of tubes not listed

**LE-HI ELECTRICAL COMPANY**  
660 Broadway Dept. RN-100 Newark 4, N. J.

**Guaranteed Factory Rebuilt Radio VIBRATORS—\$1.00**

6 volt Non Synchronous Vibrators \$1.00 ea. 6 volt Synchronous, 12, 32, and 110 volt Vibrators \$1.25 ea. Defective parts replaced. **48 HOUR SERVICE.** For the very prompt service enclose remittance and return postage. We rebuild any make or kind of radio vibrator. C.O.D. orders accepted. Send your sick vibrators to

**BEST VIBRATOR CO.**  
Box 5802, Cleveland 1, Ohio

**RADIO COURSES**

Servicing, Broadcast Engineering, Commercial Operating, Television  
INDIVIDUAL LABORATORY WORK!—LEARN BY DOING!  
DAY AND EVENING CLASSES  
Approved by the Maryland State Department of Education and the Veterans Administration  
FREE TO VETS—TEXTBOOKS, TOOLS, TEST SET

Write for Bulletin  
**BALTIMORE TECHNICAL INSTITUTE**  
1425 Eutaw Place—Dept. R. Baltimore 17, Maryland

**WIRELESS PHONO OSCILLATOR**

NO LICENSE REQUIRED  
Transmits recordings from phono pickup or voice from mike to radio without use of wires up to 500 ft. Neatly Designed.  
Complete Kit, less tubes.....\$3.49  
Above Kit assembled and tested.....\$4.49  
A Kit of tubes, 12SA7, 35Z5.....\$2.49  
Immediate delivery.  
**CONSTANT ELECTRIC**  
112 Cornelia Street Brooklyn 21, N. Y.



## SERVICEMEN—HAMS

### BARGAINS! FAST DELIVERY!

4-Tube amplifier, 110 V. @ 400 cps., can be converted to 110 V. @ 60 cps. ....	\$6.95
Radio Fuses, Ass'td sizes, 100 for. ....	3.65
0-200 Micro ammeter, 2 3/4" ....	3.98
5-Conductor Cable, 20' lengths. ....	.79
Panel-Type fuse holders, 10 for. ....	1.39
Panel-Type Neon Holders complete with bulb, 6 for. ....	1.79
Plug-in Dry Electro. Capacitor, 40-40 mfd., 250 V. DC, 6-prong mtg. bracket inc. ....	.59
Toggle Switches, Ass'td, 6 for. ....	1.95
6 V. Panel Light assemblies, 10 for. ....	3.95
Cut & Tinned hookup wire, 10 lbs. for. ....	3.69
Lip Microphone, Type T-45. ....	.89
110 V. Dry Rectifier, Half-wave. ....	1.95
110 V. Rectifier, Full-wave. ....	2.95
Meter Rectifiers, Half-wave. ....	.95
Meter Rectifiers, Full-wave. ....	1.69
Klystron Tubes, Type 723AB. ....	6.72
Dynamotors (Original Cost \$416), Input 24 V. DC @ 13 A. Outputs —300 V. DC @ 26 MA, 150 V. DC @ 100 MA, and 14.5 V. DC @ 5 Amps, with voltage regulator and built-in filter system. Complete. ....	9.95
Carbon Resistors, 500 Ass'td sizes and wattages. ....	9.95
Power Transformer, 110 V. AC primary. Secondaries: 1500 V. AC CT, two 6.3 V. AC and a 5 V. AC. Includes two 20 Hy 300 MA chokes. Entire Lot, complete. ....	7.95

### AMERICAN SALES COMPANY

1811 WEST 47th STREET, CHICAGO

## 2 & 3 Conductor Twisted Communication Type Wire

Made by Columbia for all inter-communication, transmission and various other purposes. Color coded twisted wires with Geon plastic insulation, insuring high resistance to dirt, oil, water, flame and many other normally destructive factors.

Per 1,000 feet	
2 conductor .....	\$11.07
3 conductor .....	16.71

### SPECIAL OFFER!

22 Gauge twisted pair consisting of 2 stranded wires, tinned copper shield and waxed cotton braid overall.

250 ft. coil .....	\$10.63 per coil
1,000 ft. spool .....	37.50 per spool

### Single Conductor Shielded Wire

Stranded tinned copper conductor, high dielectric insulation, with closely woven tinned copper shield overall. Ideal for shielded lead-in or wherever electrostatic shield is necessary. Put up in 500 foot metal spools.

\$9.25 per spool

Same as above, but has additional cotton braid overall.

250 ft. spool .....	\$ 7.50
1,000 ft. spool .....	28.10

See Your Local Jobber or Write Direct

Our Latest Catalog Will Be Available Shortly. Be Sure to Write for Your Copy.

Columbia Wire and Supply Company  
5736 North Elston Avenue, Chicago 30, Illinois

sales promotion service. Mr. Davis joined *Cannon Electric* in 1941 as a member of the sales-engineering staff. He holds both an electrical and civil engineering degree from the University of California.

\* \* \*

**GEORGE O. CROSSLAND** has taken over the post as district manager of the *Capehart Division, Farnsworth Television & Radio Corporation*, in the Philadelphia area.



Mr. Crossland's new territory will include Virginia, Maryland, Delaware, District of

Columbia, the eastern section of Pennsylvania and the southern half of New Jersey. He will have charge of the distribution in this area of the new *Capehart* and *Panamuse* phonograph-radio instruments.

He is a graduate of Indiana University and has been serving as assistant manager of the sales division with headquarters in Fort Wayne.

\* \* \*

**L. W. HOWARD**, formerly vice-president in charge of engineering for a West Coast transformer manufacturing company, has purchased the inventory and equipment of the *Electronic Components Company* and with O. D. Perry has formed the *Triad Transformer Mfg. Co.*, with offices and plant at 423 N. Western Avenue, Los Angeles 4, California.



Mr. Howard, who has had 16 years' experience in the transformer business, will have charge of engineering and sales and Mr. Perry, one of the founders of *Electronic Components Co.*, will be in charge of production.

The new company will manufacture specialized transformers for the radio, aviation, geophysical and other electronic fields.

\* \* \*

**SHERMAN K. HUGHES** has been named general manager of the *Mark Simpson Manufacturing Company* of Long Island City, New York, manufacturers of sound systems.



Prior to joining the *Simpson* organization, Mr. Hughes was, for many years, associated with the *Jensen Manufacturing Company* of Chicago.

His appointment is in line with the new expansion program at *MASCO* which among other things includes the expansion of manufacturing facilities of the company. A recently erected 30,000 square foot factory in Long Island City will increase the production space of the company.

# TRANSVISION

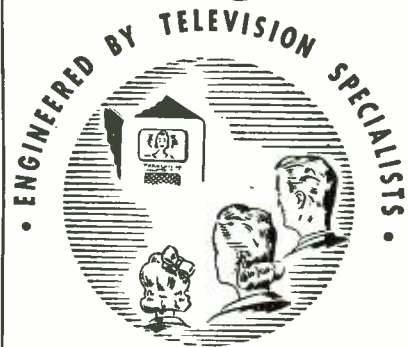

THIS NEW

## TELEVISION KIT

Offers you a High Quality TELEVISION RECEIVER

ready for Easy, Rapid Assembly

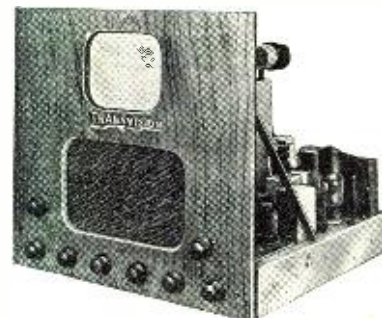

*Easy-to-Assemble: No knowledge of television required. COMPLETE easy-to-follow INSTRUCTION SHEET gives you all the knowledge you need.*

This Kit INCLUDES SOUND, all component parts, and the following:—

1. Specially designed Television Antenna.
2. A \$30.00 Lectrovision seven-inch Picture Tube . . . plus ALL other tubes.
3. Pre-tuned R-F unit.
4. Finished front panel.
5. All solder and wire . . . and sixty feet of low loss lead-in cable.

Operates on 110V.; 50-60 cycles A.C.

Price: complete with ALL tubes, \$159.50. Shipment will be made approximately 4 weeks after receipt of order. \$25.00 deposit required on all orders, balance C.O.D.

### Trade Inquiries Invited

We believe that the comparative quality of this set is superior to other available sets. For full information write to:

### TRANSVISION, INC.

108-4th Street New Rochelle, N. Y.



# Superior!



MODEL 100

ACID ETCHED PANEL

## Electronic Voltmeter Ohmmeter

Gives you constant accuracy and guaranteed performance. A stable bridge circuit type vacuum tube meter for measuring AC-DC voltages and ohms. Actual tests establish its superiority. Simple to operate. Hand calibration and hand calibrated multiplier resistors assure constant accuracy and stability.

Measures DC volts up to 600 with constant input resistance of 11 megohms. Resistor in the DC probe permits readings in signal-carrying circuits. Positive or negative indications through a reversal switch. Net price, \$75.00.

Meter Ranges: DC 0-3; 0-30; 0-150; 0-300; 0-600. Multiply by 4 with external probe. AC 0-3; 0-30; 0-150; 0-300. Ohms 0-1000; 0-10M; 0-100M; 0-1 Meg.; 0-100 Meg.

**ELECTRONIC MANUFACTURING CO.**  
714 RACE STREET, HARRISBURG, PA.

WAR SURPLUS BARGAINS

WAR SURPLUS BARGAINS

BIG SAVINGS

Hundreds of specials for RADIO SERVICEMEN

- CATHODE RAY TUBES
- POWER & TRANSMITTING TUBES
- HEADPHONES, etc.
- HARD-TO-FIND TEST METERS

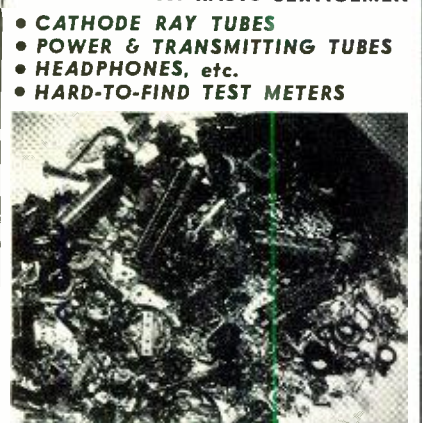

**7 LB. EXPERIMENTERS RADIO PARTS ASST.**  
A "gold mine" for the experimenter, radio serviceman, handyman and repairman. Hundreds of valuable radio, radar and electronic parts, screw machine parts, bushings, sub assemblies, etc. More than your money's worth every time. An amazing value. Money-back guarantee.

**K130R—FULL 7 POUNDS ONLY \$1.79**

War Surplus Bargain Book  
Page after page of war surplus and other bargains for the radio serviceman; also specials for home, shop and outdoors.  
**IT'S FREE! WRITE TO-DAY**

FREE CATALOG

**STARK'S** Dept. RN-1 509 So. STATE STREET CHICAGO 5, ILLINOIS

# RADIO NEWS • 1946

INDEX TO VOLUMES 35-36

<b>AMATEUR (RECEIVERS)</b>		
Converting the SCR-522 Receiver (Frank, W9JU) .....	35 Oct.	Motor-Driven Antenna (Long, W9NLP) .....
Designing the Postwar Receiver (Halligan, W9WZE & Read, W9AA) ..	50 Oct.	10-Meter Vertical Coaxial Antenna (Hays, W6RTP) .....
Super-Regenerative 2 Meter Receiver (Kirk, W3CRB) .....	30 Oct.	The Television Receiver Antenna (Teevan) .....
Super Sensitive Amateur Receiver (Hays, W6RTP) .....	32 July	<b>AVIATION</b>
Transmitter-Receiver for Ham Beginners (Sullivan) .....	32 Aug.	Future of Electronics in Aviation (Goodell & Coleman) .....
Wide-Range Converter-Receiver (Hargrove) .....	40 Feb.	Ground Control Approach System (McDuffie) .....
<b>AMATEUR (TRANSMITTERS)</b>		Highway in the Sky (Boone) .....
An Inexpensive Midget Phone-C.W. Transmitter (Turner, W1AY) .....	32 Oct.	Installation and Operation of V.H.F. Ground Transmitter and Receiving Station (Boone) .....
Autotune Transmitter AN/ART-13 (Lichterman) .....	50 Dec.	Low Power Aircraft Transmitter (Kaufman) .....
Converting the SCR-522 Transmitter (Frank, W9JU) .....	35 Nov.	Pilotless Plane Run by Radio (Winters) .....
Compact 75 Watt Transmitter (Lewis, W8MQU) .....	23 July	Planning an Aircraft Radio Installation (Scalborn) .....
Crystal Controlled 2 Meter Transmitter (Speight, W9FST) .....	36 Aug.	Radio Operated Airplane (Winters) ..
Flea Power Voice Transmitter (Kaufman) .....	35 Aug.	The Aircraft Radio Serviceman (Wayne) .....
Home Built Signal Shifter (Heytow, W9FAL) .....	48 Mar.	<b>BOOK REVIEWS</b>
Mobile—on Ten Meters (Ford, W6YT) ..	25 Dec.	A Business of My Own (Morgan) ..
New Transmitter for Amateur Radio (Bruene, W0TTK & Hale, W0JIH) ..	39 Nov.	A Chronological History of Electrical Development (National Electrical Manufacturers' Assoc.) .....
100 Watt—28 mc. Transmitter (Lefor, W2BIQ) .....	50 Apr.	Calculus Refresher for Technical Men (Klaf) .....
1000 Watt R.F. Amplifier for the Ham (Hooton, W8KPX) .....	28 May	Capacitors (Brotherton) .....
75 Watts in One Cubic Foot (Kawai, W6MNQ/9) .....	36 Dec.	Coyne Radioman's Handbook (Coyne) .....
350 Watt—5 Band Transmitter (Brier, W9EGQ) .....	40 Mar.	Electric Motor Repair (Rosenberg) ..
Transmitter for 2 Meters (Crowell, W1FEC & Parmenter, W1JXF) .....	28 June	Electrical Radio, Electronics Dictionary and Data Book (Coyne) .....
Transmitter-Receiver for Ham Beginners (Sullivan) .....	38 Sept.	Electron Optics and the Microscope (Zworykin, Morton, Ramberg, Hillier & Vance) .....
200 Watt All-band Transmitter (Hooton, W8KPX) .....	40 Nov.	Electronic Tubes, Transmitting Types (General Electric) .....
Unusual Phone Transmitter .....	35 Dec.	Electronics Dictionary (Cooke & Markus) .....
Unusual Transmitter for 28-54 mc. (Turner, W1AY) .....	40 Jan.	Inside the Vacuum Tube (Rider) ..
<b>AMATEUR (MISC.)</b>		Mathematical and Physical Principles of Engineering Analysis (Johnson) .....
All Purpose Transmitter Remote Control System (Johnson) .....	68 June	Most-Often-Needed 1946 Radio Diagrams (Beitman) .....
A Simple Remote Tuning Device for Receivers (Hannum) .....	76 Jan.	Practical Radio and Electronics Course (Beitman) .....
Combination Noise Limiter and Pre-selector (Boles & Boles, W2NBU) ..	41 July	Principles of Radio for Operators (Atherton) .....
Developments in Solid Dielectric R.F. Transmission Lines (Graham, W8LUQ) .....	46 Oct.	Radar What It Is (Rider & Rowe) ..
Make Those "Ham Fests" Interesting (Hubel) .....	90 June	Radar—What It Is and How It Works (Dunlap) .....
Microwave Pulse Modulation for Ham Communications (Endall) .....	41 Apr.	Radio Service Standard Rate Book (Oelrich) .....
Milwaukee Hams Hold Contest (Davis) .....	72 Mar.	Radio Sound Effects (Creamer & Hoffman) .....
The Deko-Xtal Holder (Ohlinger) ..	76 Aug.	Radio the Fifth Estate (Waller) .....
<b>AMPLIFIERS</b>		Radio Tube Vade Mecum, 1945 (Brans) .....
A Volume Expander Compressor (Preamplifier (Moses) .....	32 June	Reference Data for Radio Engineers (Federal Telephone & Radio Corp.) ..
Cathode Follower for Power Amplifier (Stevens) .....	52 Aug.	Soul of Lodestone (Still) .....
High-Fidelity All Purpose Amplifier (Rogers & Putman) .....	32 Apr.	Teach Yourself Radio Communication (Reid) .....
The Multiamp (Jackson) .....	58 Sept.	Television Show Business (Dupuy) ..
Unique Phono Amplifier (Peit, W2GBZ) .....	50 May	Television Simplified (Kiver) .....
<b>ANTENNAS</b>		The Radio Amateur's Handbook (ARRL) .....
A Simple Method of Controlling the Beam Antenna (E. Harris) .....	60 Aug.	Two-Way Radio (Freedman) .....
Four Element 144 mc. Rotary Beam Antennas (Brier, W9EGQ) .....	64 Sept.	Understanding Microwaves (Young) .....
		<b>BROADCASTING</b>
		From Studio to Master Control (Seitz) .....
		Listening to the World (Cross) .....



**BUSINESS MANAGEMENT**

As I See It! (Rider).....	35	Feb.
"For the Defense" (Bartels).....	70	July
Hospitalization for Radios (Sprungman) .....	45	Aug.
Income Tax Saving Facts for Radio Dealers (Ashe) .....	58	Nov.
Let's Talk Shop (Marty).....	53	Feb.
Modernize With Light (Loewe)....	30	Aug.
Patterns in Selling Radio Service (Wendel) .....	25	July
Profitable Servicing (Lowry).....	48	Sept.
Should Agencies Be Used to Collect Delinquent Accounts? (Harold)....	126	Nov.
Sound Conditioning Spurs Sales (Rowland) .....	30	Nov.
Striking Displays Can Sell Radio Service (Wendel) .....	30	Dec.
Subscription-Lease Plan (Wendel)..	54	Nov.

**CIRCUITS**

A Method of Oscillator Keying (Miller) .....	116	Sept.
Class "C" Grid Bias Modulation (Part 1) (Smith, W6BCX).....	55	Apr.
Class "C" Grid Bias Modulation (Part 2) (Smith, W6BCX).....	70	May
Designing a Stable V.F.O. (Tyler)..	54	July
Phase Inverters (Bustard).....	57	Feb.
Sound Amplification by Air-Stream Modulation (McQuay) .....	39	Dec.

**CIRCUIT PAGE**

Admiral Model 6A1.....	Sept.
Arvin Models 444, 444A.....	Nov.
Automatic Model 611.....	June
Automatic Model 640.....	Dec.
Belmont Model 5D128.....	Nov.
Belmont Model 6D111.....	May
Bendix Models 526A, 526B, 526D, 526E	June
Clarion Model C100.....	May
Clarion Model C101.....	July
Clarion Model C104.....	May
Crosley Models 56TA, 56TW, 56TC.	May
Crosley Model 56TX.....	Aug.
Crosley Models 66CP, 66CA, 66CQ.	May
Detrola Model 568.....	May
DeWald Models A500, A501, A502, A503 .....	May
Emerson Model 505.....	Oct.
Emerson Model 510, Chassis 120000, 120029 .....	July
Emerson Model 519.....	Aug.
Farnsworth Model ET-060, ET-061, ET-063 .....	Oct.
Farnsworth Models ET-064, ET-065, ET-066 .....	Aug.
Garod Model 5A2.....	July
Garod Model 5D.....	Sept.
Garod Model 6AU-1.....	Nov.
General Electric Models 100, 101, 103, 105 .....	July
General Electric Models 219, 220, 221	Nov.
General Electric Model 321.....	Oct.
General Electric Models YRB60-1, 60-2 .....	Dec.
Grantline Models 605, 606.....	Nov.
Hoffman Model A300.....	Oct.
Hoffman Model A302.....	June
Howard Model 901.....	Aug.
Meck, Models 5C5, A, B, C.....	May
Olympic Models 6-501, 6-502, 6-503.	Oct.
Packard-Bell Model 651.....	Sept.
RCA Models 54B1, 54B1-N, 54B2, 54B3 .....	May
RCA Models 56X, 56X2, 56X3.....	July
RCA Model 56X10.....	Aug.
RCA Models Q10, Q10A.....	Dec.
Radiola Models 61-1, 61-2, 61-3.....	May
Radiola Models 61-5, 61-10.....	Oct.
Sparton Model 5-06.....	Sept.
Stewart-Warner Model 9000-B.....	Dec.
Stewart-Warner Model 9014-E.....	June
Stromberg Carlson Model 1100, Series 10 .....	June
Stromberg Carlson Model 1101, Series 10-11 .....	Sept.
Teletone Series D.....	Dec.
Temple Models E-510 to E-519.....	May
Travler Karenola Model 5000.....	May

January, 1947

**Service—**

**Service—**

**Service—**

**SERVICE - Our Guiding Policy**

● For nearly 20 years, Radio Parts Company has used as a watchword—SERVICE. We have felt and still feel that a company will grow and prosper according to the measure of service it provides for its customers.

● During the past war years, we did our level best to serve all equally in furnishing hard-to-get radio parts. We are proud of our record of seeing that radio service men, amateurs and others received the parts essential to their work.

● In the coming years, we pledge ourselves to continue serving the radio industry to the best of our ability. You can count on Radio Parts Company in the future, as in the past, for dependable parts at all times.

WRITE TODAY FOR OUR LATEST POST WAR CATALOG.

**RADIO PARTS COMPANY**

612 W. Randolph St., Dept. C, Chicago, Illinois



Years of experience and research have enabled HALLDORSON designers and engineers to produce transformers of the highest quality.

Look for the well-known HALLDORSON trademark when ordering transformers. It is your guarantee of high quality backed by long experience. . . . We are developing additional and improved transformers to make our line more complete.

Join the list of alert jobbers who are planning to carry this better line of transformers. **WRITE TODAY.**

**THE HALLDORSON COMPANY**  
since 1913  
4500 Ravenswood Avenue • Chicago 40, Illinois

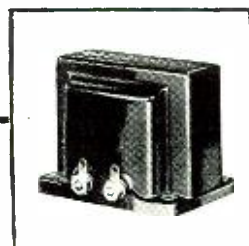

**HALLDORSON**  
*Vacuum Sealed*  
**TRANSFORMERS**



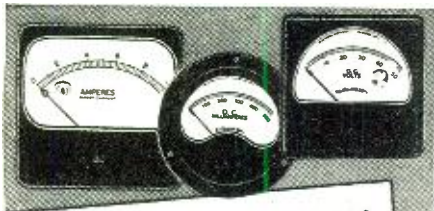

... **PRECISION IS BASIC**

WITH **Burlington**  
**INSTRUMENTS**

These are the features that make Burlington Instruments your logical choice — Alnico Magnets used in all DC moving parts—Perfectly aligned Jewel Supports—Phosphor bronze control springs — Ceramic pointer stops—non-shifting balance weights. All ranges AC or DC available in 2½", 3½", 4½" sizes, rectangular and round.

Inquiries solicited

**BURLINGTON INSTRUMENT CO.**

912 Fourth Street  
BURLINGTON, IOWA

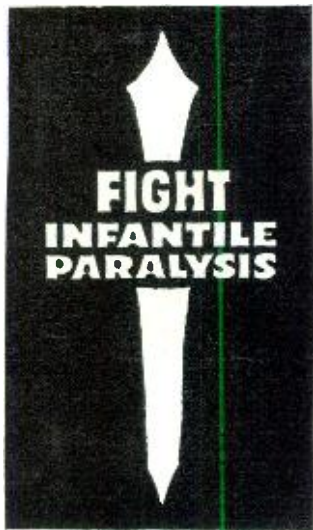

**MARCH OF DIMES**

**JANUARY 15-30**

"No victim of poliomyelitis—regardless of age, race, creed or color—shall be deprived of care and treatment for want of money." — *National Foundation for Infantile Paralysis.*

Your help is needed! Join the **March of Dimes.**

Trav-ler Karenola Model 6000..... May  
Truetone Models D2610, D2611..... Sept.  
Truetone Model D2615..... May  
Truetone Model D2616..... Nov.  
Vogue Models 553R, 554R..... July  
Ward Models 54BR, 1503A, 1504A. May  
Ward Models 64BR-1205A, 1206A.. Dec.  
Westinghouse Models H-122, H-130. June  
Westinghouse Models H-125, H-126. Aug.

**CODE**

Code Practice Oscillator (Chalfin)... 29 Sept.  
C.W. Break-in Monitor (Bard, W6EOS) ..... 45 July

**COMMUNICATIONS**

New Radio Dispatching System (Hubel) ..... 68 Mar.  
Two-Way Radio for Everyone (Freedman) ..... 25 Sept.

**ELECTRONICS**

Build Your Own High-Speed Photo Flash (Dezettel) ..... 52 Dec.  
Electronic Air-Filter (Taylor)..... 52 May  
Electronic Developments in the Rubber Industry (Routh)..... 44 Dec.  
Electronic Metal Analyzer (Winters) 28 Nov.  
Electronics Afloat (Kamen)..... 56 Sept.  
Electronics in Processing Foods (Winters) ..... 31 June  
Self-Synchronous Transmission System (Hansen) ..... 38 Feb.

**ELECTRO-OPTICS (PHOTO-ELECTRIC, ETC.)**

Photo-Electronic Organ (Part 1) (Campbell & Greenlee)..... 25 June  
Photo-Electronic Organ (Part 2) (Campbell & Greenlee)..... 36 July

**EQUIPMENT (TEST)**

Additional Notes on R.F.-I.F.-A.F. Signal Tracer (Cavaleri)..... 66 Apr.  
A Linear Sweep Generator (Haywood, W20QB) ..... 78 Nov.  
All Wave Signal Generator (Goldberg, W2HKU) ..... 32 Nov.  
A Per-cent Modulation Meter (Turner, W1AY) ..... 43 May  
A Precision Frequency Standard (Saxon) ..... 36 Apr.  
A Precision Resistance Bridge (Dexter) ..... 36 Sept.  
Audio Oscillators (Hoadley)..... 38 Aug.  
Constructing a Grid Dip Meter (Burgess, W9TGU) ..... 50 Aug.  
Crystal Controlled Signal Generator (Johnson) ..... 42 Dec.  
Home-Built Vacuum Tube Voltmeter (Smith) ..... 48 July  
"Juke Box" Analyzer (Turner, W1AY) 41 Sept.  
LCR Meter for Amateur Use (Bernard, W4ELZ) ..... 40 June  
Low Cost Audio Oscillator (Ehrlich). 50 Nov.  
Multi-Range Milliammeter (Turner, W1AY) ..... 49 Feb.  
New High-Gain Visual-Aural Signal Tracer (Silver) ..... 36 Oct.  
135 to 500 mc. Signal Generator (Wonsowicz, W9DUT & Brier, W9EGQ) ..... 35 Jan.  
R.F.-I.F.-A.F. Signal Tracer (Cavaleri) 50 Jan.  
R.F. Probe Design (McAvoy)..... 35 Mar.  
Simple Square-Wave Generator (Hoadley) ..... 48 Dec.  
Test Oscillator TS-47/APR (Moore).. 32 May  
The Multivibrator as a Service Instrument (Ross) ..... 120 June  
Universal Test Instrument (Silver).. 32 Feb.  
V.H.F. Heterodyne Frequency Meter (Goldberg, W2HKU) ..... 32 Mar.

**FACSIMILE**

Possibilities of Home Facsimile (Feldman) ..... 49 Nov.

**FREQUENCY MODULATION**

A Simple FM Converter (Kees)..... 31 May  
FM in Canada (Holloway)..... 30 Jan.

**INDUSTRY**

1946 Radio Parts and Electronic Equipment Conference and Show 46 May  
Radio Heating in Textile Industry (Batsel) ..... 44 Oct.

**TELEVISION COMPONENTS**

**MAGNETIC DEFLECTION YOKES:—**  
No. DY-1S. 5 mh type. For 55° deflection angle as required by 9JP1, 7CP1, 10BP4, 10EP4, etc. 2¼" long, 2½" deep...\$14.75  
No. DY-2L. 5 mh type. For 40° deflection angle as required by 9AP4, 12AP4, 5TP4 etc. 3½" long, 2½" deep...\$15.75  
No. DY-4L. 1.5 mh type as required for TRK-120 and similar receivers. Construction identical to No. DY-2L.....\$15.75

**FOCUS COILS:—**  
2000 ohms, 1000 volt ins. test, 1½" I.D., 4¾" O.D. These are brand new, war surplus, a real buy!!.....\$4.50

**BLOCKING OSCILLATOR TRANSFORMERS:—**

No. OT-103H. For 15,750 cycle oscillators. Housed in very attractive metal case, lug terminals .....\$4.75  
No. OT-101H. Same as No. OT-103H, uncased .....\$3.25  
No. OT-104V. For 60 cycle oscillators. Housed in very attractive metal case, lug terminals.....\$3.95  
No. OT-102V. Same as No. OT-104V, uncased .....\$2.50  
Probably available through your local jobber. If not, order direct. Additional literature available on request.

**THE ELECTRON COMPANY**  
1988 East 59th Street. Cleveland 3, Ohio

*Supplying Every Electronic Need*

- For the—
- Radio Service Man
  - Amateur
  - Student
  - Experimenter
  - Industrial

Write For Illustrated Price List

**GRABREE'S**  
**WHOLESALE RADIO**  
DALLAS 2608 ROSS AVE. TEXAS

**SOUND RECORDING SCHOOL**

A practical 9 months' course in Sound Fundamentals, Recording, and Sound Transmission measurements; in a laboratory containing transmission sets, oscillators, square wave generator and intermodulation analyzer, and other equipment.

Two complete recording studios assimilating broadcast, motion picture and commercial sound recording, under the direction of H. M. Tremaine.

Approved for Veterans  
**DON MARTIN SCHOOL OF RADIO ARTS**  
1655 Cherokee St., Hollywood, Calif.

**SERVICE MEN!**

Red hot values in tubes and parts. Write for our latest list of test equipment.

**RCA • Hickok • Triplett • Simpson**

**CHIEF ELECTRONICS**

104 Main Street Poughkeepsie, N. Y.

**FILMGRAPH PAT'D**  
**Conference Recorders**

UNINTERRUPTED Longtime (up to 12 hours) Conference & Telephone Recordings on Safety Film Models for Dictation "TALKIES"

ECONOMICAL PERMANENT INSTANTANEOUS PLAY-BACK

MILES REPRODUCER CO., INC. 812 BROADWAY, N.Y. 3 RN-1

**CRITICAL RADIO TUBES**

Write For List & Discounts

**BILL'S RADIO REPAIR SHOPS**

Dept. N1, 2038 Washington Street  
Boston 19, Mass.



**AMATEURS  
EXPERIMENTERS  
SERVICE MEN**

**Supplies & Equipment**  
*Leading Brands*

★

Headquarters for  
**HALLICRAFTERS  
NATIONAL HAMMARLUND**

★ ★ ★

**RADIO PARTS DISTRIBUTING CO.**  
128 W. Olney Road  
Norfolk, Va.

**A TOOLSHOP  
IN YOUR HAND**

Smooth, steady power at your fingertips for buffing scratched cabinets, metals, corroded tube and socket pins; removing burrs; sanding, etc. Grinds, drills, saws, engravers, etc. AC or DC. Wt. 12 oz. 25,000 r.p.m. In steel case with complete accessory assortment, postpaid, \$27.50. Handee only with 7 accessories, \$20.50.

**A Fine Gift for a Friend or yourself! Order Now! Prompt Delivery**

**FREE! 52-Page Manual**  
CHICAGO WHEEL & MFG. CO.  
1101 Monroe St., Dept. RE  
Chicago 7, Ill.

**HANDEE** TOOL OF 1001 USES

**BUFFALO'S LEADING  
SUPPLY HOUSE**

In the BUFFALO Area  
see **DYMAC INC.** for your  
radio and electronic parts and  
equipment

**Dymac INC.**

2329-31 Main Street, Buffalo 14, N. Y.

**TWO-WAY RADIO**  
by **SAMUEL FREEDMAN**

An excellent book for planners and users of two-way radio communication. Complete detailed explanation of the mechanics and application. How and where it is used—by police and fire departments, railroads, truckers, and other industries.

\$5.00 at your bookstore, or from  
**ZIFF-DAVIS PUBLISHING CO.**  
185 N. Wabash Ave., Chicago 1, Ill.

Report on European Radio Industry (Laden) ..... 25 May

**INSTRUCTION (COURSES)**

Practical Radio Course (Part 40) (Ghirardi) ..... 57 Jan.

Practical Radio Course (Part 41) (Ghirardi) ..... 50 Feb.

Practical Radio Course (Part 42) (Ghirardi) ..... 46 Mar.

Practical Radio Course (Part 43) (Ghirardi) ..... 46 Apr.

Practical Radio Course (Part 44) (Ghirardi) ..... 48 May

Practical Radio Course (Part 45) (Ghirardi) ..... 55 June

Practical Radio Course (Part 46) (Ghirardi) ..... 42 July

Practical Radio Course (Part 47) (Ghirardi) ..... 46 Aug.

Practical Radio Course (Part 48) (Ghirardi) ..... 46 Sept.

Practical Radio Course (Part 49) (Ghirardi) ..... 52 Oct.

Practical Radio Course (Part 50) (Ghirardi) ..... 40 Dec.

Saga of the Vacuum Tube (Part 21) (Tyne) ..... 50 Feb.

Saga of the Vacuum Tube (Part 22—Conclusion) (Tyne) ..... 52 Apr.

Television Sweep Oscillators (Part 11) (Noll) ..... 52 Jan.

Synchronizing and Separation Circuits (Part 12) (Noll) ..... 54 Mar.

Television Deflection Channels (Part 13) (Noll) ..... 55 May

Television Voltage Circuits (Part 14A) (Noll) ..... 50 June

Operation and Adjustment of Television Receivers (Part 14B) (Noll) ..... 47 July

Television Alignment (Part 15) (Noll) ..... 53 Sept.

Trouble Shooting the Television Receiver (Part 16—Conclusion) (Noll) ..... 52 Nov.

**METAL LOCATORS**

Treasure Finding Modernized (Osborne) ..... 30 Sept.

Try This 1946 Treasure Finder (Osborne) ..... 36 Nov.

**MILITARY**

Arctic Oil Exploration (Roberts) ..... 25 Mar.

Drones—Prelude to "Push-Button" Warfare? (Read) ..... 25 Oct.

Invisible Light Aids Marksman ..... 35 June

Operation Crossroads (Read) ..... 25 Aug.

Operation Crossroads (Read) ..... 32 Sept.

Radio News to Cover—Operation Crossroads ..... 30 July

Radio Teletype in the AACS (Lambe) ..... 52 Mar.

The Army's Radio Relay Equipment (Boone) ..... 25 Jan.

The Signal Corps On—and In—the Air ..... 94 Jan.

The "Spindle Eye" (Luichinger) ..... 32 Dec.

**OSCILLOSCOPES**

A Writing Cathode-Ray Tube (Lineback) ..... 30 Feb.

Build this 5" Cathode-Ray Oscilloscope (Greenlee) ..... 40 Oct.

**PHONO**

A Non-Electrical Phonograph (Kaufman & Kaufman) ..... 53 June

**POWER SUPPLIES**

Constant 6 volt D.C. Supply (Springer) ..... 44 June

Designing an Auto-Transformer (Parmenter, WIJXF) ..... 47 Dec.

Recent Developments in Heavy Duty Vibrator Type Power Supplies (Williams) ..... 46 June

**RADAR, LORAN, SHORAN**

Radar Reaches the Moon (Gootée) ..... 25 Apr.

Shoran for World Mapping ..... 112 Aug.

Spotting Hurricanes and Thunderstorms by Radar (Winters) ..... 45 Mar.

**RADIO COMPONENTS (TESTING)**

Determining the Resistance of a Sensitive D.C. Meter (Dexter) ..... 80 Mar.

Meet the Microphone (Seitz) ..... 28 Aug.

**— LAKE —**

**Amplifying Systems**



**LAKE SENIOR**

Excellent-ly de-signed, compact amplifiers, ideal for students, professional entertainers, homes, factories, schools, etc. Perfect for voice-musical instruments, pickups and contact microphones; clear, rich tone; heavy plywood in luxurious leatherette-covered, sturdy, limited portable cabinets.

**As listed below:**

No.	Watts	Inputs	List.	Your Cost
A18	16	4	\$110.00	\$64.68
A19	16	4	97.50	52.88
A12	12	2	87.50	51.45
A 8	8	1	75.00	51.45
A 6	6	2	75.00	44.10
A 5	5	2	60.00	35.28
A C-DC Model	8	1	75.00	44.10

**HAWAIIAN ELECTRIC GUITAR**  
Beautiful black plastic, trimmed with chrome. 23" scale, 4½ octaves of playing range. List \$50.00. Your Cost ..... **\$29.40**



**Deluxe  
PHONO  
CABINET**

Covered in luxurious, genuine brown leatherette, has deluxe brass hardware throughout, made completely of plywood with brown plastic handle, has padded top and bottom. Motor board 14" x 14". Overall dimensions 16" L. x 15" W. x 8" H. Your net Price ..... **\$8.95**



Portable Phonograph case, of sturdy, durable plywood, in handsome brown leatherette finish. Inside dimensions 16½" long, 13" wide, 9½" high. Has blank motor board. As illustrated above, specially priced at ..... **\$6.95**

Also blank table cabinets of walnut veneer in the following sizes, with speaker opening on left front side: (\*Nre: \*\* has center speaker grill.)

#1	18½"	L x 3½"	H x 4"	D \$1.95
#2	18½"	L x 6½"	H x 5"	D \$2.75
#3	18½"	L x 7½"	H x 6¼"	D \$3.25
#7	18½"	L x 7"	H x 5½"	D \$2.50

\*Speaker opening in center of front side.

All types of radio cabinets and parts are available at Lake's Lower prices. A large stock is listed in our catalog.

**SERVICEMEN—RETAILERS**  
Write for our new, illustrated 16-page catalog NR-116. It's free. Get on our mailing list! Write for our Special Catalog on Microphones, Amplifiers and Sound Equipment!

**Order from Lake!**  
**You'll make no mistake!**  
Dept. A

**Lake Radio Sales Co.**  
615 W. Randolph Street  
Chicago 6, Ill.



# CLEAN ACCURATE HOLES

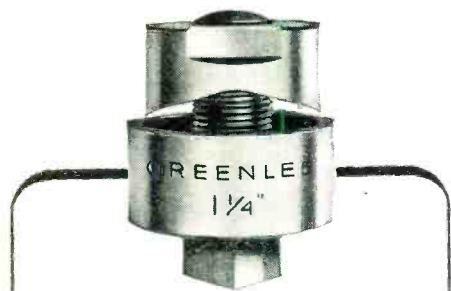

## cut in radio chassis

Greenlee Punches make this tough job easy. No reaming, filing or tedious drilling. Tool has three parts: *punch* cuts through chassis, *die* supports metal to prevent distortion, *cap screw* is turned with wrench to cut holes. Sizes for holes 3/4" to 3 1/2". Ask your radio supply or electrical jobber or write for folder and prices. Greenlee Tool Co., 1881 Columbia Ave., Rockford, Illinois.

WRITE FOR FREE FOLDER S-119



# For Soldering in Tight Places...

## DRAKE

No. 400 Soldering Iron

*Smallest Industrial Iron Ever Designed*  
60 Watts—1/4 in. Tip  
Only 9 in. long—Wt. only 8 oz.

This mighty mite is backed by DRAKE'S 25 years of soldering iron manufacturing experience. The high quality and long service of DRAKE Soldering Irons have made them outstanding favorites with all types of radio men everywhere. The DRAKE No. 400 is an outstanding value at

Only \$4.50 List

Drake Has an Iron for Every Purpose  
Ask Your Radio Parts Jobber



**DRAKE ELECTRIC WORKS, INC.**  
3656 LINCOLN AVE. CHICAGO 13, ILL.

New Selenium Rectifiers for Home Receivers (Eannarino) ..... 45 Nov.  
R.F. Chokes at U.H.F. (Stolze) ..... 54 Jan.

### RECEIVERS

A Novel 2-Tube Receiver ..... 124 Aug.  
High Fidelity Receiver (Hoadley) ... 46 Nov.  
The 1946 Radio Parade ..... 30 Mar.  
The "Super-3" ..... 76 June

### RECORDING

Embossing Sound on Film (Kempner) 36 June  
Improved Sound Reproducer (Volf) .. 38 Jan.  
Serviceman's Recording Studio (Paige) ..... 35 Apr.  
Spotting and Repeating Record Player (Bailey) ..... 29 Feb.

### SERVICE TECHNIQUES

Alignment of Radio Receivers (Cunningham) ..... 38 Oct.  
100 mc. Receivers Require New Servicing Techniques (Gunn) .... 36 May  
Simple Rack Speeds Record Changer Repairs ..... 86 June

### SHORT-WAVE LISTENER

International Short-Wave (Boord) ... 43 Jan.  
International Short-Wave (Boord) ... 43 Feb.  
International Short-Wave (Boord) ... 44 Mar.  
International Short-Wave (Boord) ... 45 Apr.  
International Short-Wave (Boord) ... 54 May  
International Short-Wave (Boord) ... 49 June  
International Short-Wave (Boord) ... 50 July  
International Short-Wave (Boord) ... 55 Aug.  
International Short-Wave (Boord) ... 60 Sept.  
International Short-Wave (Boord) ... 49 Oct.  
International Short-Wave (Boord) ... 44 Nov.  
International Short-Wave (Boord) ... 54 Dec.

### TELEVISION

Direct-Wire Television (Taylor) ..... 38 Apr.  
Practical Television (Monfort) ..... 38 May  
Television for Urbanized Areas (Duvall) ..... 88 Jan.  
Television Must Sound Right (Hubbell) ..... 46 Feb.  
Television Receivers (Monfort) ..... 41 Aug.

### TESTING

Resistance Measurements (Litt, W2LCC) ..... 44 Jan.

### THEORY

Analysis of Parasitic Oscillations in Radio Transmitters (Jackson, W9DZR) ..... 68 Feb.  
Analysis of Radio Interference Phenomena ..... 54 June  
Service Considerations in Megacycle Bands (Sheridan) ..... 38 Mar.  
Velocity Modulation (Kauke) ..... 44 Feb.

### U.H.F.

A Resonant Cavity Wavemeter (McQuay) ..... 36 Feb.  
Frequency Measurements at U.H.F. (Endall) ..... 50 Sept.  
Introduction to U.H.F. Frequency Measurements (Dexter) ..... 32 Jan.

-50-



RADIO NEWS

# EASY TO LEARN CODE

It is easy to learn or increase speed with an Instructograph Code Teacher. Affords the quickest and most practical method yet developed. For beginners or advanced students. Available tapes from beginner's alphabet to typical messages on all subjects. Speed range 5 to 40 WPM. Always ready—no QRM.



### ENDORSED BY THOUSANDS!

The Instructograph Code Teacher literally takes the place of an operator-instructor and enables anyone to learn and master code without further assistance. Thousands of successful operators have "acquired the code" with the Instructograph System. Write today for convenient rental and purchase plans.

# INSTRUCTOGRAPH COMPANY

4711 SHERIDAN ROAD, CHICAGO 40, ILLINOIS

# WAR SURPLUS

CENTRALAB—3000 VDC 50 mmfd. type 850. silver Ceramic. 10 for ..... \$1.39  
SPRAGUE—metal-encased, oil impregnated, tubular condensers 600 VDC .1 mfd. 24 for ..... \$2.19 100 for ..... \$8.49  
CRYSTALS—Sylvania type 1N21, high frequency, plug-in receiving (makes a fine meter rectifier). 2 for ..... .98c  
JACKS—Signal Corps type JK34A, short phone jack. 10 for ..... .98c  
MICAMOLDS—.01 mfd, 400 Volt, molded-in-lite. 25 for ..... \$1.09 100 for ..... \$3.98  
IRC RESISTORS—10,000 Ohm, 10 Watt, type AB, cement coated. 25 for ..... \$2.19 100 for ..... \$8.49  
Write for circular listing many other outstanding values. SPECIAL DISCOUNTS on quantities. Shipping extra.  
Erie Supply Co. 88 Exchange St. Rochester, N.Y.



# SOLVE TRIG PROBLEMS QUICKLY WITH EASY TO USE QUICK TRIG

This NEW IDEA in a slide rule enables you to solve QUICKLY trig., radio, electricity, and carpentry problems. Simply set the slides. Right in front of you are the answers for All THREE sides and angles of a triangle. Gives degrees and tangents of angles. No need to figure with paper and pencil. Easy instructions included.

### SINE CIRCLE

This completes all your trig needs. It gives trig. functions such as sine, cos., tangent, secant, etc., for the complete 360 degrees. Both for only \$1.50 postpaid, or we will send C.O.D., plus postage, by return mail.



REED MFG. CO., 124 W. 4th St., Los Angeles 13, Calif.

# RADIO

RADIO Technician and Radio Communications courses. Register now for new classes starting first MONDAY of each month. Day and Evening Classes.

### AMERICAN RADIO INSTITUTE

101 West 63d St., New York 23, N. Y.  
Approved under GI Bill of Rights.

# RADIO CABINETS RADIO FURNITURE JACK CANTOR

171-A Washington St. New York 6, N. Y.

# CONDENSERS

50 paper and mica condensers \$1.00. Brand new, fine assortment, popular sizes. Wt. app. 1 lb. f.o.b. Cash, check or M. O.  
Kensington, P.O. Box 91, Bklyn. 18, N. Y.



# Technical BOOKS

**"THE SERVICING OF TELEVISION RECEIVERS"** by the *Philco Service Division*. Published by *Philco Corporation*, Philadelphia. 135 pages. Price \$2.25.

Every radio serviceman should own a copy of this book against the day when he will be called upon to service television receivers in his shop.

In the brief span of 135 pages the men of the Service Division at *Philco* have managed to crowd an amazing amount of *practical* information. They have wisely left the discussion of television theory to the engineering texts and have gotten down to brass tacks to deal with some of the problems that will confront the serviceman who has to service the new television receivers now coming from the production lines.

The book is divided into five sections, the basic television system, the composite video signal, the television receiver, television antennas, and servicing the television receiver. Within this structure the authors have presented pictorial material, circuit diagrams and tables, all of which can be used at once by the serviceman.

For those servicemen who are located in areas already boasting of television service, this book is an immediate must. To those for whom television is a thing of the future, a word of warning—it is not too early to study up on the subject.

\* \* \*

**"COMMUNICATION THROUGH THE AGES"** by Alfred Still. Published by *Murray Hill Books, Inc.*, New York. 194 pages. Price \$2.75.

It was with the pleasure at meeting an old friend that this reviewer welcomed the third book from the pen of Mr. Still for, here again, the author has presented another interesting facet in the vast field of electricity, in the thoroughly readable style which characterizes all of Mr. Still's books.

The reader cannot help but feel that the author truly enjoys writing these little books—for so easy and natural is his style that the reader can easily visualize himself having a chat with Mr. Still on the subject rather than reading the story from the printed page.

This time the story deals with all forms of communication from sign language to modern television. The need to communicate with one's fellow man is a basic human need and an exposition of how men have gone about satisfying this desire through the years makes good reading.

This book should find a place in the bookshelves of many homes, both for its interest and the essential information it contains.

\* \* \*

**"RADIO'S CONQUEST OF SPACE"** by Donald McNicol. Published by *Murray Hill Books, Inc.*, New York. 364 pages. Price \$4.00.

January, 1947



## UTC FOR HIPERM ALLOY TRANSFORMERS

The UTC Hiperm alloy audio transformers are specifically designed for portable and compact service. While light in weight and small in dimensions, neither dependability nor fidelity has been sacrificed. The frequency characteristic of the Hiperm alloy audio units is uniform from 30 to 20,000 cycles. These units are similar in general design and characteristics to the famous Linear Standard audio Series.

### UTC HIPERM ALLOY TRANSFORMERS FEATURE . . .

**True Hum Balancing Coil Structure** . . . maximum neutralization of stray fields.  
**Balanced Variable Impedance Line** . . . permits highest fidelity on every tap of a universal unit . . . no line reflections or transverse couplings.  
**Reversible Mounting** . . . permits above chassis or sub-chassis wiring.  
**Alloy Shields** . . . maximum shielding from induction pick-up.  
**Multiple Coil, Semi-Toroidal Coil Structure** . . . minimum distributed capacity and leakage reactance.  
**High Fidelity** . . . UTC Hiperm Alloy Transformers have a guaranteed uniform response of  $\pm 1.5$  dB from 20-20,000 cycles.

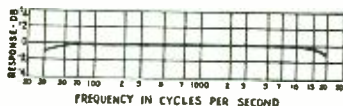

Typical Curve for HA Series

TYPE NO.	APPLICATION	PRIMARY IMPEDANCE	SECONDARY IMPEDANCE	$\pm -1$ DB FROM	MAX. LEVEL	MAX. UNBAL. DC IN PRIMARY	LIST PRICE
HA-100	LOW IMPEDANCE MIKE, PICKUP, OR MULTIPLE LINE TO GRID.	50, 125, 200, 250, 333, 500 OHMS	60,000 OHMS IN TWO SECTIONS	30-20,000	+22 DB	5 MA	\$18.60
HA-100X	SAME AS ABOVE BUT WITH TRI-ALLOY INTERNAL SHIELD TO EFFECT VERY LOW HUM PICKUP						23.95
HA-101	LOW IMPEDANCE MIKE, PICKUP, OR MULTIPLE LINE TO PUSH-PULL GRIDS.	50, 125, 200, 250, 333, 500 OHMS	120,000 OHMS OVER ALL, IN TWO SECTIONS	30-20,000	+22 DB	5 MA	21.25
HA-101X	SAME AS ABOVE BUT WITH TRI-ALLOY INTERNAL SHIELD TO EFFECT VERY LOW HUM PICKUP.						26.60
HA-108	MIXING, LOW IMPEDANCE MIKE, PICKUP OR MULTIPLE LINE.	50, 125, 200, 250, 333, 500 OHMS	50, 125, 200, 250, 333, 500 OHMS	30-20,000	+22 DB	5 MA	18.60
HA-106	SINGLE PLATE TO PUSH-PULL GRIDS.	8,000 TO 15,000 OHMS	135,000 OHMS 1.5:1 RATIO, EACH SIDE	30-20,000	+22 DB	0	15.95
HA-113	SINGLE PLATE TO MULTIPLE LINE.	8,000 TO 15,000 OHMS	50, 125, 200, 250, 333, 500 OHMS	30-20,000	+22 DB	1 MA	17.95
HA-134	PUSH-PULL 89'S OR 2A3'S TO LINE.	5,000 TO 10,000 OHMS	50, 125, 200, 250, 300, 500 OHMS	30-20,000	+32 DB	5 MA	19.95
HA-135	PUSH-PULL 2A3'S TO VOICE COIL.	3,000 TO 5,000 OHMS	30, 20, 15, 10, 7.5, 5, 2.5, 1.2	30-20,000	+32 DB	5 MA	18.60

THE ABOVE LISTING INCLUDES ONLY A FEW OF THE MANY HIPERM ALLOY TRANSFORMERS AVAILABLE . . . WRITE FOR CATALOG.

**FOR IMMEDIATE DELIVERY**

From Your Distributor



*United Transformer Corp.*  
 150 VARICK STREET NEW YORK 13, N. Y.  
 EXPORT DIVISION: 13 EAST 40TH STREET, NEW YORK 16, N. Y. CABLES: "ARLAB"



*Quality Dependability*

## RADIO KITS

KIT-MODEL SK

- 5-Tube AC-DC Super-Het 550-1750 KC
- 40-60 Cycle 105-125 Volt AC-DC
- Walnut Plastic Cabinet 9½" x 6" x 5" Included
- 5" Alnico 5 PM Speaker
- Matched IFs, Loop and Oscillator Coils Assure High Gain Reception
- All Parts Mounted for Easy Assembling
- Only First Quality Standard Parts Supplied
- Instructions and Diagram Assure Easy Wiring
- Uses 50L6 — 35Z5 — 12SA7 — 12SQ7 — 12SK7

**YOUR COST \$11.95, less Tubes, Wire, Solder.**

Send 10% or More with Order  
 Kit of Matched Tubes, RCA or Equal, \$4.95

**GROSSMAN RADIO & ELECTRIC CO.**

WHOLESALE DISTRIBUTORS

CABLE ADDRESS: GRECOLEC

120 CEDAR STREET  
 NEW YORK 6, N. Y.

BRclay 7-2685  
 2686



# HOPP Plastic RADIO DIALS

DIAL WINDOWS, NAME PLATES, GAUGES, CALCULATORS, SCALES, CHARTS, ETC.



PLASTIC RADIO DIALS have endless possibilities in design, size, shape and color combination. Attractive and durable, our radio dials, windows and scales are preferred by many leading Radio manufacturers.

Not only for dials, but for numerous other electronic and electrical applications, Laminated Plastics are preferable.

Consult with our artists and engineers regarding applications for your particular purpose. Or . . . send us your blue prints or samples for quotation.

**THE HOPP PRESS, INC.**  
460 W. 34th STREET, NEW YORK 1, N. Y.  
ESTABLISHED 1893

## RADIO PARTS SOUND SYSTEMS ELECTRONIC APPARATUS

## Depend on RADOLEK

Radolek's big Free Profit Guide Catalog and Profit Bulletin supplements keep you abreast of the rapidly changing radio situation. Buying from Radolek means greater values, better service and more profits. Make Radolek your buying headquarters.

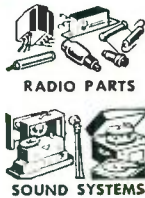

RADIO PARTS  
SOUND SYSTEMS

FREE  
CATALOG



Large Stocks  
Fast Service

**SEND TODAY!**

RADOLEK CO., Dept. B-122  
601 W. Randolph St., Chicago 6, Ill.  
Please send your FREE Profit Guide Catalog.

Name.....  
Address.....

**SAVE AT RADOLEK**

That most people take radio for granted is a foregone conclusion, but at times it is well to look back and review the monumental work that has been accomplished in a relatively short space of time.

Evidently the author felt that just such a survey should be made, for Mr. McNicol, himself an engineer and past president of the I.R.E., has drawn on his vast experience and the memories of those still living who saw the beginnings of radio, to present this most readable story of the conquest of space.

While the presentation is non-technical, the author has not "written down" to an audience but assumes that, like himself, his readers are interested in some of the early experimental work done in the radio field.

This book should engender in the hearts of all who work in the radio industry a feeling of pride over the accomplishments of a vast group of scientists, both named and unknown, who in the short span of a lifetime have conceived and brought to fulfillment the industry as it stands today.

-30-

### Spot Radio News

(Continued from page 18)

for experimental facsimile and picture transmission. Facsimile also includes, of course, transmitting newspapers over the air, hot off the press.

**NOT ON THE** immediate television horizon, but far enough along to have won favorable comments from FCC experts who saw it demonstrated recently, is the *Radio Corporation of America's* aviation device, Teleran. This is a televised blind flying system whereby a televised navigation map of the area over which the plane is flying appears continually on a screen on the plane's instrument panel. Superimposed over the televised map are radar blips which indicate every plane in the area at the altitude where the aircraft is flying. Changes in any flight condition are noted on the screen as quickly as they occur. RCA believes that Teleran promises to revolutionize post-war aerial navigation and remove a majority of the collision and bad-weather hazards now inherent in flying.

**EQUALLY INTERESTING** and doubtless a dramatic source for news stories of the future was a recent FCC announcement put out in routine fashion on the granting of authority to School District No. 9, Glacier County, Montana, to construct seven provisional stations. They will operate in the intermittent service on a temporary basis. Purpose: to be used as a safety and health-protection measure. School district headquarters plan to go on the air, especially during the winter months, when roads are bad and

## Classified

Rate 20c per word. Minimum. 10 words

### RADIO ENGINEERING

RADIO Engineering Broadcasting, Aviation and Police Radio, Servicing, Marine Operating and Electronics taught thoroughly. Expenses low. Write for catalog. Valparaiso Technical Institute. Dept. N. Valparaiso, Ind.

### FOR SALE

BARGAINS. Tubes. Parts. Supplies. Write: J. C. Thimijan, Lake City, Minn.

I. C. S. RADIO Servicing Course, \$10.00; Modern Radio Servicing, \$2.50; Radio Physics Course, \$2.50. Wendel Calkins, Lambertton, Minn.

WATERS Conley ink tape recorder, \$98.50; Gray Electric Automatic Keyer, \$42.50; Records & sends to 400 W.P.M., both \$138.00; R-100 A.C. D.C. Batt. receivers, transmitters, test equipment, meters, ham parts. Real bargains. Send for complete list. Steval Radio Co., 41 Amboy St., Brooklyn 12, N. Y.

SELENIUM Rectifiers, full wave, 1/2 ampere, \$1.85; 1 ampere, \$2.50. Half wave 5 amperes, \$4.50; 2.2 amperes, \$2.25; 1.5 ampere, \$1.85. Bulletin. Bursma Radio, Route 5, Grand Rapids, Mich.

TELEVISION Parts: 10 and 12 inch cathode ray tubes very reasonably priced and the following parts in kit form—deflecting coils—focusing coils—picture and sound i.f. channels using the latest circuits with the newest miniature tubes. R.F. high voltage power supplies and R.F. tuners. These units are built on subchassis for mounting on main chassis. Send for our price list now. Television Specialties Co., 315 Madison Street, Oak Park, Ill.

LOWEST Prices. Radio Tubes, parts. Bargain lists 3c. Potter, 1314 McGee, Kansas City 6, Mo.

RADIO Tubes—Dealers, order your needs—be surprised at prices. Address Radio Tubes, Box 108, Elizabeth City, N. C.

BC-221 FREQUENCY Meter Power Supplies with mixer tube built in for modulating R. F. output. \$23.50. Television Specialties Co., 315 Madison Street, Oak Park, Ill.

RADIO cabinets, new, 3000, wooden, walnut, mahogany, table model, slide rule dial. Size 14" x 7" x 9". Box 441, % Radio News.

PE-103A DYNAMOTORS, new postpaid, \$19.95. BC-223A Transmitters, new, postpaid, \$27.50. Free list. Erecoc, 1006 Hewitt, Everett, Wash.

BARGAIN: Raytheon quality power transformers 570V C. T. 65 mils, 6.3V 2A., 5V 2A., electrostatic shield. \$2.50 plus shipping. Kalawaia Mfg. Co., 44 1/2 So. Main St., Salt Lake City, Utah.

MELLOTONE radios. 5 tube superhet completely wired & tested. Beautiful modern plastic cabinet. Any color desired. Satisfaction assured. \$19.95 less tubes. \$4.50 for tubes. Uses 12SA7—12SK7—12SQ7—50L6—35Z5. Mellotone Radio Co., 505 Forsgate Dr., Jamesburg, N. J.

GREATEST bargain! Oil condensers, 4-mfd. 1000v, six for \$5.88. Hand mikes \$2.85. Motorola Dual Vibrator Power Supplies 6v input, 540v, 160 mils output \$17.85. Vibroplex-type Keys \$9.85. Everything brand new! Send 25% deposit, balance C.O.D. Offenbach-Reimus, 372 Ellis, San Francisco 9, Calif.

SELSYN beam rotation kit complete, 110 VAC operated. Includes pair selsyns, motor, drive gears, switches, etc. \$22.50, postpaid. Erecoc, 1006 Hewitt, Everett, Wash.

10-METER receiver kits, \$3.99. Details free. "Radio," 349 Ave.-E, Bayonne, N. J.

SIGNAL TRACER: Save \$17.45. I'm closing shop. Will sell brand new SPECO Model STAP AC-DC for \$27.50. Cost me \$44.95. Send check, money order or C.O.D. to M. H. B. Hoffman, 4112 Galatin St., Hyattsville, Md.

WIRE recorders, radio equipment, 1/2 to 1/2 normal price. Surplus, Box 18, Station G, Brooklyn 22, N. Y.

### CORRESPONDENCE COURSES

CORRESPONDENCE Courses and self-instruction books, slightly used. Sold. Rented. Exchanged. All subjects. Satisfaction guaranteed. Cash paid for used courses. Complete information and 100-page illustrated bargain catalog FREE! Write Nelson Company, Dept. 59, Chicago 5, Ill.

**RADIO NEWS**



RADIO communications course. Complete preparation for First and Second Class Commercial Radiophone licenses. Supervised home study permitting progress as fast as your ability and time will allow. Text books, note book, sixty lessons and receiver kit furnished. Approved as a correspondence school under the laws of the State of New York. Empire Radio School, Dept. B, Box 1170, Rochester, N. Y.

USED Correspondence Courses and Educational Books sold or rented. Inexpensive. Money-back guarantee. Write for Free Catalog listing 4000 bargains.—(Courses Bought.)—Lee Mountain, Pisgah, Ala.

AMATEUR radio licenses. Complete code and theory preparation for passing amateur radio examinations. Home study and resident courses. American Radio Institute, 101 West 63rd Street, New York City.

RADIOTELEPHONE first class sample tests, \$10.00. We correct. New correspondence course. Box 1298, Hollywood, Calif.

USED Correspondence Courses, Educational and Technical Books bought, sold, rented. Catalog free. Educational Exchange, Henagar, Ala.

### WANTED

PRE-WAR Model Scott Phantom DeLuxe radiophonograph combination. Either AM or FM-AM. State condition, features of set, & price FOB Chicago. Ray Hood, Box 486, Tonopah, Nev.

### PATENT ATTORNEYS

PATENTS—U.S. and Foreign Patents Secured. Trade-marks and Copyrights registered. Searches made to determine Patentability and Validity. Patent, Trade-mark and Unfair Competition Causes. Lancaster, Allwine & Rommel, Registered Patent Attorneys, Suite 414, 815 15th St., N.W., Washington 5, D. C.

INVENTORS—Steps to be taken in obtaining patent protection available upon request. Victor J. Evans & Co., 248-A Merlin Bldg., Washington 6, D. C.

### HELP WANTED

SALES representative to call on radio, music, appliance dealers, servicemen with nationally advertised line of Test Equipment. Generous commission. Metropolitan Electronics, 6 Murray St., New York, N. Y.

IMMEDIATE openings: AM, FM, TV transmitter operators, instructors, announcer-operators—first class radiotelephone license. EEs, design—production. Radio's Reliable Resources (Employment Bureau), Box 413, Philadelphia, Pa.

### FOR EXPORT

FIVE and Six tube all metal cabinet superhets available in beautiful cabinet. All voltage ranges. Fulton Distributors, 3349 Fulton Road, Cleveland 9, Ohio. Tel. SH. 1916.

### MISCELLANEOUS

RADIO wholesale repairs. Just send us the radio prepaid, we repair and return C.O.D. You add markup and deliver. Complete stock. We fix them all. 48 hrs. service. Our low prices mean more markup profits for you. Ship to Elkins Radio, Elkins, W. Va.

THIS is it—your big opportunity. Become independent—operate as you please—spare or full time—right from your own home. Great Booklet "How to Build Your Own Mail Order Business." Only 25c. Satisfaction or money back. Merit Products, 216-32 132 Ave., Springfield Gardens 13, New York, N. Y.

RUBBER stamps. Any wording. 3 lines, \$1.00. Clifford Jones, 1210 N. Dudley Ave., Utica 3, N. Y.

WRITE S&G Instrument Co. for sheet metal work, engraving, machining; for fine equipment to your specifications. Box 1461, Tulsa, Okla.

ELECTRICAL instruments. Meters repaired and converted. Inquiries solicited. Haledon Electrical Instrument Co., 319 Belmont Ave., Haledon, N. J.

YOUR test equipment defective? Let us relieve you of that source of irritation. We do quick, efficient repair on all types of radio and electrical test equipment. All work guaranteed. Everett Electronic Instrument Co., 2302 Grand Ave., Everett, Wash.

RAILWAY telegraphy. Be a railroad telegrapher. Operators are in great demand. Salaries from \$3,200 up. For information write to Bell Telegraph Ry. Institute, 10 Parker Ave., Suite 9, San Francisco 18, Calif.

YOUR call in 4" Neon tube letters, any color. Hangs near antenna lead as power on or off signal. \$9.95 money order or check with order. Specify color. P. C. Sales Co., 170 E. California St., Pasadena 5, Calif.

snows are heavy. On the receiving end will be schools located in the isolated areas on the Blackfeet Indian Reservation, where telephones are lacking.

The school fathers were authorized by FCC "to engage in communications pertaining to safety of life and property and, secondly, to transmit essential communications relative to the district." Frequency 31.02 mc. has been awarded conditionally. Power is not to exceed 50 watts and there will be A3 and special emission for FM (telephony). Equipment will be determined subject to FCC approval. We like to imagine a teacher at one of the isolated schools getting the district superintendent on the phone to bawl out her worst pupil, but FCC insists that medical and health advice will be the most important matters for broadcast.

GERMANY, post-war model, was described the other night in the most vivid detail we've heard for some time by Lt. Col. Richard H. Ranger, a research engineer who recently brought back about a ton of Nazi electrical equipment. Details on it have been released to American industry by the Department of Commerce. He's a Signal Corps expert with a prewar background that included inventing a number of developments in facsimile picture transmission. Most of the highly technical fields in Germany he found pretty well wrecked, and further difficulty is being experienced gathering good technicians from the various zones of influence to put factory staffs together and begin postwar production.

Some progress has, however, been made—Col. Ranger himself was helpful in getting German newsreels back into operation. He also reports that they did wonders with color photography during the war, and showed some excellent movies to prove it. . . . His favorite gadget, which he demonstrated, he called the Magnetophone, a device for recording and reproducing sound on magnetized tape. It is said to do the best work of this kind to date, picking up sounds as light as minus 60 decibels. The best until Magnetophone was minus thirty. Col. Ranger demonstrated his finds before the *Institute of Radio Engineers* at a meeting in Washington.

—30—

### ERRATA

Through a typographical error, R<sub>10</sub>, R<sub>15</sub> in the parts list on page 37 of the Oct. issue was shown incorrectly. The value should be 270,000 ohm, 1/2 w. resistor.

In the Oct. issue, page 41, the value of R<sub>13</sub> should be 25,000 ohm, 3 w. res. instead of 25,000 ohm, 1/2 w. res.

### Photo Credits

Pages	Credit
25, 27, 138	U. S. Army Air Forces
30, 32	Walter Steinhart, Staff Photographer
32, 33, 34, 154	General Electric
36	Superior Instruments Co.
44	Sylvania Electric Company
46, 47, 80	Parkard-Bell Company
48	U. S. Army Signal Corps
51 (top left)	Proctor Electric Company by Arthur Haug, Staff Photographer
51 (top right)	Electronic Corporation of America
88	Press Wireless
122	Raytheon
139	Electronic Laboratories

In New Jersey...  
...it's **VARIETY**

**SUPERIOR MODEL CA-12**

*Signal Tracer*



Price **34.85**

**FEATURING**  
Simple Operation...  
only one connecting cable... No tuning Controls. A new Superior Instrument Product. Complete with Probe, Test Leads, Batteries and Instructions.

**SUPERIOR Model 670 Super-Meter A Combination**

Volt-Ohm Milliammeter plus Capacity Reactance Inductance and Decibel Measurements.



Complete with test leads and instructions ..... **\$28.40**

### RADIO KITS by "EASY BUILT"

**Model No. 2B**



Battery operated, easy tuning, attractive wood finish cabinet. Complete with Tube, Coil, Battery, Headphone, Hardware and Base.

List Price.. \$4.98  
**Special \$3.33**

No. 2 Kit. AC-DC. Electric Battery Kit with Cabinet complete with Tube, Special Variable Condenser, Earphones, Resistors, Hardware and Special Fittings, Completely Wired Tube Socket. Diagram on Mounting Base—Ready Cut and Drilled.

**\$5.01** each

Kit No. 1 ..... **\$2.13**  
Kit No. 1X ..... **\$2.13**

### Federal Teleco SELENIUM RECTIFIER

Replaces Rectifier Tube..... **\$1.09** each  
6 or more..... **.99c** each

### Bargain!

#### 100 Assorted Bypass Condensers

10—.001—600v	10—.01—600v
15—.002—600v	10—.02—600v
10—.005—600v	10—.05—600v
15—.006—600v	10—.1—600v
	10—.5—200v

Value ..... **\$11.00**

**Special \$6.95**

#### FILTER CONDENSER KITS 23 Assorted Types

Value ..... **\$12.00**

**Special \$8.75**

Dumont 5" Scope..... **\$99.50**  
HYQ 75 Kit—unassembled \$9.95—  
assembled ..... **\$11.95**

Write Dept. N-1 for our FLYER. 20% Deposit with order required. Please add sufficient postage. Excess will be refunded.

*Variety* **ELECTRIC CO., Inc.**  
601 Broad St., Newark 2, N. J.



# INDEX OF ADVERTISERS

January  
1947

<p>Abell Distributing Company, The Brodx Advertising Agency..... 126</p> <p>Adson Radio Co. Bass &amp; Weber Co., Inc..... 136, 157</p> <p>Air King Radio Henry A. Loudon, Advertising..... 85</p> <p>Alliance Manufacturing Company Foster &amp; Davies, Inc..... SECOND COVER</p> <p>Allied Radio Corp. George Brodsky, Advertising..... 9, 106</p> <p>Alsam Products Company Sander Rodkin, Advertising..... 151</p> <p>American Phenolic Corporation Burton Browne, Advertising..... 21</p> <p>American Radio Institute Sternfield-Godley, Inc..... 164</p> <p>American Sales Company Signet Corporation, The..... 159</p> <p>American Television &amp; Radio Co. Firestone-Goodman, Inc..... 92</p> <p>Arrow Electronics Company Bass &amp; Weber Co., Inc..... 102</p> <p>Arrow Sales, Inc..... 125</p> <p>Ashe, Walter Radio Co..... 143</p> <p>Audel, Publishers Grant &amp; Wadsworth, Inc..... 100</p> <p>Baker-Phillips Company Foulke Advertising Agency..... 104</p> <p>Baltimore Technical Institute..... 158</p> <p>Bell Telephone Laboratories N. W. Ayer &amp; Sons, Inc..... 59</p> <p>Best Vibrator Company..... 158</p> <p>Bill's Radio Repair Shops..... 162</p> <p>Bishop Engr. Co. Robert Gallagher Service..... 120</p> <p>Bliley Electric Company Hardy Advertising Agency..... 23</p> <p>Bliss Electrical School N. W. Ayer &amp; Sons, Inc..... 132</p> <p>Brach, L. S. Mfg. Corp. United Advertising Agency..... 86</p> <p>Brooks, George &amp; Associates Schram Company, The..... 154</p> <p>Bud Radio, Inc. Allied Advertising Agency..... 134</p> <p>Buffalo Radio Supply International Advertising Agency..... 93</p> <p>Burlington Instrument Company Weston-Barnett, Inc..... 162</p> <p>Burstien-Applebee Co. Frank E. Whalen, Advertising..... 169</p> <p>Buyers Syndicate..... 142</p> <p>Cambridge Electronics Corporation Candler System Co. Rand-Ries, Advertising, Inc..... 120</p> <p>Cannon Electric Development Co. Dana Jones Company..... 129</p> <p>Cantor, Jack Altomari Advertising Agency..... 164</p> <p>Capitol Radio Engineering Institute Henry J. Kaufman, Advertising..... 83</p> <p>Chicago Industrial Instrument Co. Turner Advertising Agency..... 149</p> <p>Chicago Wheel &amp; Mfg. Co. Western-Barnett, Inc..... 163</p> <p>Chief Electronics..... 162</p> <p>Clarion Sound Engineering Co..... 133</p> <p>Cleveland Institute of Radio Electronics Kenneth H. Kolpien..... 86, 104, 139</p> <p>Clippard Instrument Lab., Inc. Savage &amp; Talley..... 158</p> <p>Collins Radio Company McCann-Erickson, Inc..... 77</p> <p>Columbia Wire &amp; Supply Co. Sander Rodkin Advertising Agency..... 159</p> <p>Communications Equipment Co. Borough Advertising Agency..... 20</p> <p>Concord Radio Corporation E. H. Brown Advertising Agency..... 58</p> <p>Constant Electric..... 158</p> <p>Cornell Dubilier Electric Corp. Reiss Advertising Agency..... BACK COVER</p> <p>Coyne Electrical School McJunkin Advertising Agency..... 132</p> <p>Coyne Electrical School The Phil Gordon Agency..... 150, 152</p> <p>Crabtree's Wholesale Radio..... 162</p> <p>Croname, Inc..... 109</p> <p>DeForest's Training, Inc. Lauesen &amp; Salomon, Advertising..... 15</p> <p>D &amp; H Distributing Co., Inc. Business Service Agency..... 66</p> <p>D H D Electronics &amp; Appliance Co. Bruce Lindeke Advertising..... 110</p> <p>Dow Radio..... 122</p> <p>Drake Electric Works, Inc. William Hoffman &amp; Associates..... 164</p> <p>Dymac, Inc. Harold Warner Co..... 163</p> <p>Editors &amp; Engineers..... 103</p> <p>Electronics Institute, Inc..... 144</p> <p>Electronic Manufacturing Co. Business Service Co..... 160</p>	<p>Electronic Parts, Inc. Campbell-Reynolds, Inc..... 116, 122</p> <p>Electronic Supply Corp. Regent Advertising Agency..... 120</p> <p>Erie Supply Company..... 164</p> <p>Esse Radio Company Gary A. Ruben Advertising..... 22</p> <p>Fada Radio and Electric Company, Inc. Sternfield-Godley, Inc..... 6</p> <p>Fahnestock Electric Company, Inc..... 94</p> <p>Federal Telephone &amp; Radio Corporation Rickard &amp; Company, Inc..... 10, 11</p> <p>Federated Purchaser, Incorporated Altomari Advertising Agency..... 144</p> <p>Fessler Engineering Co. George Brodsky, Advertising..... 112</p> <p>Flanagan Radio Corporation Stewart-Jordan Corp..... 122</p> <p>General Cement Mfg. Co. Turner Advertising Agency..... 136</p> <p>General Electric Company Maxon, Inc..... 65</p> <p>General Electronic Distributing Co..... 140</p> <p>General Industries Co., The Fuller &amp; Smith &amp; Ross, Inc..... 98</p> <p>General Test Equipment Co. Suzanne Hayman, Advertising..... 154</p> <p>Greenlee Tool Co. Howard H. Monk &amp; Associates..... 164</p> <p>Greenwich Sales Co. Bass &amp; Weber Co., Inc..... 118</p> <p>Groban Supply Company A. L. Addison Company..... 120</p> <p>Grossman Radio &amp; Electric Co. Arnold Cohan Corp..... 165</p> <p>Guardian Electric Kennedy &amp; Co..... 107</p> <p>Halldorson Company, The Sander Rodkin Advertising Agency..... 161</p> <p>Hallicrafters Company, The Burton Browne Advertising..... 5</p> <p>Hammarlund Mfg. Co., Inc., The Roeding &amp; Arnold, Inc..... 24</p> <p>Harrison Radio Corporation Altomari Advertising Agency..... 60</p> <p>Harvey Radio Co. Shappe-Wilkes, Inc..... 76</p> <p>Henry Radio Burton Browne Advertising..... 70</p> <p>Hershel Radio Company Hugh-Allen Advertising..... 80</p> <p>Hexacon Electric Company George Homer Martin, Advertising..... 118</p> <p>Highbridge Radio-Television &amp; Appliance Co. Sternfield-Godley, Inc..... 150</p> <p>Hollywood Sound Institute, Inc. Nelson Advertising Agency..... 130</p> <p>Hoodwin, Charles Company..... 132</p> <p>Hopp Press, Inc., The Gallard Advertising Agency..... 166</p> <p>Hytron Radio &amp; Electronics Corp. Henry A. Loudon, Advertising..... 69</p> <p>Illinois Condenser Company Sander Rodkin Advertising Agency..... 145</p> <p>Instructograph Company Turner Advertising Agency..... 164</p> <p>Instrument Service Co. Purnies &amp; Associates..... 154</p> <p>International Resistance Co. John Falkner Arndt &amp; Co..... 57</p> <p>Jensen Manufacturing Co. Burton Browne Advertising..... 170</p> <p>J.F.D. Mfg. Co. Bergman-Jarrett Company..... 155</p> <p>Johnson, E. F., Company David, Inc..... 82</p> <p>Joseph, Irving Schram Company, The..... 156</p> <p>Kelvin Electronics Sternfield-Godley, Inc..... 124</p> <p>Kenyon Radio Supply Co. Henry J. Kaufman Company..... 72, 149</p> <p>Kenyon Transformer Co., Inc. Jasper, Lynch &amp; Fishel, Inc..... 118</p> <p>Knapp Radio Specialties Company..... 130</p> <p>Kwikheat Sylvester Advertising Agency..... 131</p> <p>Lake Radio Sales Co. Sander Rodkin Advertising Agency..... 163</p> <p>Leari S. Company Cromwell Advertising Agency, Inc..... 150</p> <p>Le-Hi Electrical Company..... 158</p> <p>Leonard Radio, Inc. Sternfield-Godley, Inc..... 128</p> <p>Leotone Radio Co. Altomari Advertising Agency..... 64</p>	<p>Liberty Sales Co., Inc. Bass &amp; Weber Co., Inc..... 136</p> <p>Liberty Sales Co., Inc. Sternfield-Godley, Inc..... 68</p> <p>Lifetime Sound Equipment Co. Miller Advertising Agency..... 154</p> <p>Lincoln Engineering School Buchanan Thomas, Advertising..... 130</p> <p>Lippma, Aaron and Co..... 130</p> <p>Lukko Sales Corporation Sander Rodkin Advertising..... 153</p> <p>Mac's Radio Supply..... 140</p> <p>Maguire Industries, Inc. City Advertising Agency..... 90, 91</p> <p>Mallory, P. R. &amp; Co., Inc. Aitkin-Kynett Co., The..... 13, THIRD COVER</p> <p>Maritime Switchboard..... 149</p> <p>Martin, Don School of Radio Arts..... 162</p> <p>Merit Coil &amp; Transformer Corp. Merrill Symond, Advertising..... 14</p> <p>Melville Radio Institute Seidel Advertising Agency..... 143</p> <p>Metropolitan Electronic &amp; Instrument Co. Bass &amp; Weber Advertising Agency..... 81</p> <p>Mid-America Co., Inc. E. H. Brown Advertising..... 138</p> <p>Midwest Radio Corporation Savage &amp; Talley, Inc..... 121</p> <p>Miles Reproducer Co., Inc. Altomari Advertising Agency..... 162</p> <p>Millen, James Mfg. Co., Inc. James Millen, Inc..... 12</p> <p>Milo Radio &amp; Electronics Corp. Burke &amp; Wayburn Advertising Agency..... 102</p> <p>Minerva Corp. of America Herbert Chason Advertising..... 75</p> <p>Montgomery Ward Foote, Cone &amp; Belding..... 157</p> <p>Murray Hill Books, Inc. Harry P. Bridge Company..... 16, 17</p> <p>McGee Radio Co. Clyde H. Smith, Advertising..... 119</p> <p>McGraw-Hill Book Co..... 150</p> <p>McMurdo Silver Company Edward Owen &amp; Company..... 124, 169</p> <p>National Company, Inc. Graydon Smith &amp; Co..... 61</p> <p>National Radio Distributors Bass &amp; Weber Co., Inc..... 122</p> <p>National Radio Distributors Burke &amp; Wayburn, Inc..... 76</p> <p>National Radio Institute Vansant, Dugdale &amp; Co., Inc..... 3</p> <p>National Radio Service Co..... 146</p> <p>National Schools Mayers Company, The..... 19</p> <p>National Schools Stodel Advertising Agency..... 62</p> <p>National Union Radio Corporation Hutchins Advertising Agency..... 113</p> <p>Newark Electric Company, Inc. Charles Brunelle Company..... 111</p> <p>Newark Surplus Materials Co. William N. Scheer..... 158</p> <p>New York Radio Company Bass &amp; Weber Co., Inc..... 144</p> <p>New York Technical Institute of New Jersey Schwab &amp; Beatty, Inc..... 114, 115</p> <p>Niagara Radio Supply Burke &amp; Wayburn Advertising Agency..... 135</p> <p>Ohmeyer Engineering Labs..... 146</p> <p>Olson Radio Warehouse, Inc. Jessop Advertising Agency..... 137</p> <p>Pa-Kette Electric Co. Arrow Advertising Agency..... 150</p> <p>Petersen Radio Company Bozell &amp; Jacobs..... 148</p> <p>Potter Radio Company..... 151</p> <p>RCA Institutes, Inc..... 122</p> <p>R-L Electronic Corp. R. S. Wittenberg, Advertising..... 76</p> <p>Radio City Products Company, Inc. Reiss Advertising Agency..... 73</p> <p>Radio Dealers Supply Co. Bass &amp; Weber Co., Inc..... 88</p> <p>Radio Electric Service Co. of Penna. Inc. David Zibman, Advertising..... 158</p> <p>Radio Equipment Distributors Ross, Gardner &amp; White, Advertising..... 102</p> <p>Radio-Experts..... 148</p> <p>Radio Ham Shack, Inc. J. R. Kupstik, Advertising..... 105</p> <p>Radio Kits Company Hamburger Advertising Agency..... 136, 148</p> <p>Radio Maintenance Magazine Shappe-Wilkes, Inc..... 87</p> <p>Radiomart, Inc. Ferwerda-Boone, Inc..... 145</p>
---	--	---



Radio Parts Company	161
Sidney S. Lovitt	163
Radio Parts Distributing Co.	140
Radio Press	101
Radio Shack, Inc., The	127
Schram Company, The	130
Radio Supply & Engineering Co., Inc.	144
Karl G. Behr, Advertising	120
Radio Television Supply Company	147
Radio & Television Supply	166
Thomas H. Stevenson	154, 164
Radio Wire Television, Inc.	71
Reiss Advertising Agency	82
Radionic Equipment Co.	
Bass & Weber Co., Inc.	
Radolek Company	
Turner Advertising Agency	
Reed Mfg. Co.	
Borg Advertising Agency	
Rider, John F., Publisher, Inc.	
Lansford F. King, Advertising	
Rowe, Industries	
Miller Advertising Agency	

Sams, Howard W. & Co., Inc.	67
Aitkin-Kynett Co., The	148
Sauereisen Cements Co.	154
Koppers Company	139
Scenic Radio & Electronics Co.	152
S/C Laboratories, Inc.	140
Gallard Advertising Agency	95
Sigmon's Radio Supply	7
Advertising, Inc.	157
Sound Products Company	108
Kameny Associates	96
Sprague Products Company	160
Harry P. Bridge, Company	132
Sprayberry Academy of Radio	18
Harry P. Bridge, Company	99
Stahl, Michael, Inc.	148
Bass & Weber Co., Inc.	78, 79
Standard Parts Corp.	151
Bass & Weber Co., Inc.	117
Standard Radio & Electronic Products Co.	84
Mount Printing Co.	97
Stark's	
A. L. Addison, Company	
Sterling Electronic Company	
Stevens Walden, Inc.	
Howard Wesson Co.	
Sun Radio of Washington, D. C.	
Kal, Ehrlich & Merrick	
Sun Radio & Electronics Co.	
Bass & Weber Co., Inc.	
Superior Instruments Company	
Bass & Weber Co., Inc.	
Supreme Instruments Corp.	
O'Callaghan Advertising Agency	
Supreme Publications	
Henry H. Teplitz Advertising Agency	
Surplus Radio, Inc.	
Bass & Weber Co., Inc.	
Sylvania Electric Products, Inc.	
Newell-Emmett Company	

T A B	
Bass & Weber Co., Inc.	74
Taybern Equipment Co.	148
Bass & Weber Co., Inc.	162
Telectron Company, The	159
Transvision, Inc.	154
H. J. Gold, Advertising	141
Tri-State College	
Clem J. Steigmeyer, Advertising	
Triplett Electrical Instrument Co.	
Western Advertising Agency	

Ungar Electric Tools	
Walter C. Davison	155
Union Radio Corporation	98
Sander Rodkin Advertising Agency	165
United Transformer Corp.	132
Shappe-Wilkes, Inc.	
Universal Radio Supply Company	
Stevens-Hall Advertising	

Valparaiso Technical Institute	
Smith, Benson & McClure, Inc.	150
Vasco	120
Variety Electric Co., Inc.	167
Bass & Weber Co., Inc.	

Warner Electric Company	
Mason Warner Company	144
Webster-Chicago	8
William Hoffman & Associates	153
Weller Mfg. Co.	
Beaumont, Heller & Sperling, Inc.	89
Wells Sales, Inc.	
Turner Advertising Agency	
World Radio Laboratories, Inc.	
Pfeiffer Advertising Agency	63

YMCA Trade & Technical Schools	
Cecil Presbrey, Inc.	148

January, 1947

# WITH SILVER "VOMAX" YOU CAN—



Measure every type and kind of voltage in receiver design and servicing. "VOMAX" increases your efficiency and profits by equipping you to measure r.f., i.f., a.f.—actual signal volts—a.v.c., a.f.c., discriminator—a.c. and d.c. volts. Input resistance is so astronomically high you can measure directly even in the highest resistance circuits. "VOMAX" is also your output db. meter; measures direct current up thru 12 Amp. auto set range; resistance up to 2,000 megahms.

Post-war design and construction at pre-war uninflated price is the secret of overwhelming demand for "VOMAX", the true v.t.v.m. Unequaled at any price, it is bought and used by the Bureau of Standards, Navy, F.C.C., E.A.A., schools, universities, research laboratories—and by thousands of experience-wise service technicians. You, too, will find "VOMAX" your greatest profit meter. Only \$59.85 at your favorite jobber.

OVER 35 YEARS OF RADIO ENGINEERING ACHIEVEMENT

*McMurdo Silver Co., Inc.*

1240 MAIN ST., HARTFORD 3, CONNECTICUT

Send postcard for new catalog of measuring instruments, communication receivers, transmitters, kits and parts. See them at your favorite jobber.

## BA BARGAIN SPECIALS

Buy Them with the Confidence—that even tho' at RIDICULOUSLY LOW PRICES—You will Get BRAND NEW TOP QUALITY GOODS

### FOR "GE" PORTABLES

2 volt Willard type 20-2 the exact replacement in Pre-War Model LB 530 "GE" Portable Radios. Also for other sets. Gangs nicely in multiples of 3 for 6 volts. In Plastic Case size 3 31/32 x 3 1/2 x 5 1/2" high. Shipped Dry. Uses standard battery electrolyte available everywhere.

Regular List Value \$8.75  
No. 5A142,  
Every One Brand New. Each **\$3.95**

### CODE PRACTICE SET

Consist of a top quality key and a Signal high frequency adjustable buzzer mounted on a black bakelite base, equipped with binding posts, ready for quick and simple connections to the 4 1/2 volt battery included. Complete ready to use.

Stock No. 5A145  
Each **\$2.95**  
Only **\$2.95**

Complete Nothing Else to Buy

### The FINEST in HEADPHONES

Type P23. The Choice of the Air Corps headphones, highly sensitive, 8000 ohm impedance, bipolar magnets. Extremely comfortable sponge rubber ear cushions — stainless steel leather covered headband—concealed terminals—Six Foot Cord with PL55 plug. EVERY ONE BRAND NEW in Original Factory Cartons.

Stock No. 5A134  
An Outstanding Buy, Only **\$2.95**

### CODE PRACTICE OSCILLATOR

Complete Nothing Else to Buy

Operates from 110 volts AC or DC. Plenty of Volume from Quality Midget Speaker. Complete with tube, high grade key, cord and plug—

Just Plug It In and it is ready to operate.

Stock No. 5A146  
A REAL BUY Each **\$8.95**

Terms—Cash with order or C. O. D. with 20% deposit. Add Postage.

# BA BURSTEIN-APPLEBEE

EVERYTHING IN

## RADIO AND ELECTRONIC DEVICES

1012-14 MCGEE STREET, KANSAS CITY 6, MISSOURI



# Listen!

## 2 NEW Jensen Extended Range High-Fidelity PM SPEAKERS

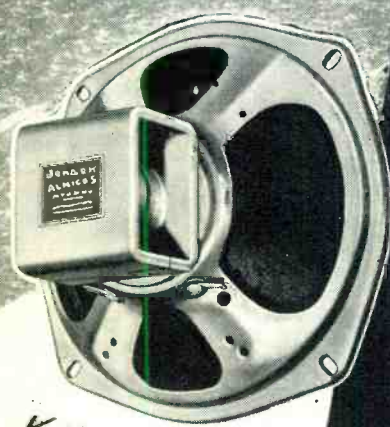

These two Jensen speakers, with *ALNICO 5* PM design, provide excellent high-fidelity performance. Excellent as replacement and modernizing units for FM and television receivers, radio-phonograph combinations, for studio monitoring, wired music, and for similar applications. Installed in Jensen Bass Reflex\* cabinets, they provide exceptionally high-quality reproduction with added octaves of bass response.

### Listen ... it's a Jensen SPEAKER

Model P12-SH (Superseding PM12-CT). A new 12-inch high-fidelity *ALNICO 5* PM speaker. Designed for use with Jensen Model A-121 or Model D-121 Bass Reflex cabinets. Maximum power handling capacity in speech and music systems, 8 watts. Voice coil impedance, 6-8 ohms.

Standard Fidelity Model P12-S. Voice coil impedance, 6-8 ohms. Power handling capacity in speech and music systems, 10 watts.

### Listen ... it's a Jensen SPEAKER

Model P8-SH (Superseding PM8-CT). A high-fidelity 8-inch *ALNICO 5* PM speaker. Recommended for use with Jensen Model A-81 Bass Reflex cabinet. Maximum power handling capacity in speech and music systems, 6 watts. . . . Voice coil impedance, 6-8 ohms.

Standard Fidelity Model P8-S. Voice coil impedance, 3-4 ohms. Maximum power handling capacity in speech and music systems, 8 watts.

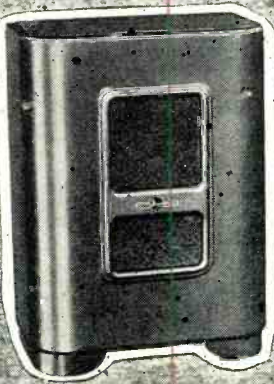

Model A-81 —  
for Model P8-SH speaker  
Model A-121 —  
for Model P12-SH speaker

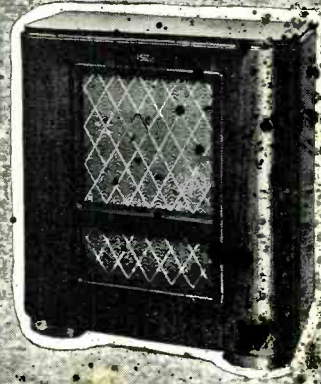

Model D-121 —  
for Model P12-SH speaker

### BASE REFLEX CABINETS



## Jensen SPEAKERS WITH *ALNICO 5*

*Designers and Manufacturers of Fine Acoustic Equipment*

JENSEN MANUFACTURING CO., 6617 S. LARAMIE AVE., CHICAGO 38, U. S. A.

In Canada: Copper Wire Products, Ltd., 11 King St. W., Toronto, Ont.

PRINTED IN U. S. A.



# HELLO! CHECK THESE "GET ACQUAINTED" VALUES! SPEAKERS

**5" P.M.** 1 oz. ALNICO 5 MAGNET **\$139**  
6 for \$8.00

6" PM 1 oz. Alnico 5 Magnet.....\$1.79  
6" PM 2.15 oz. Alnico 5 Magnet..... 2.79  
8" PM 20 oz. Slug \$4.95 12" PM20 oz. Slug. 8.95

## VOLUME CONTROLS

**1/2 MEG** with switch and 2" shaft **75¢**  
6 for \$4.25

Kit of 10 assorted controls, without switch. \$1.95

## WIRE

Approximately 400 ft. of Wire in assorted colors and gauges, solid and stranded in 2 to 4 feet lengths, per pkg. **99¢**  
2 pkgs. for \$1.90

#20 shielded wire, stranded, per ft. ....\$ .03  
2 conductor mike cable, per ft. .... .06  
Radio grade spaghetti, 1c ft., # 20 solid push-back, 1c ft.

## CABINETS

**PORTABLE PHONOGRAPH CASE** two-toned  
Leatherette finish, Dimensions  
15 3/4" L x 14 3/4" W x 8" H..... **\$995**

**Portable Automatic Phono-graph Record-Changer Case** **\$1495**

## TRANSFORMERS

**70 MIL POWER TRANSFORMER 600V.**  
6.3V @ 3 Amp. C.T., 5V @ 3 Amp. .... **\$295**  
3 for \$8.00

50 Mil Power 500V, 6.3V @ 2 Amp. 5V @ 2 Amp. ....\$1.95  
90 Mil Power 500V, 6.3V @ 3.5 Amp. 5V @ 3 Amp. .... 3.25  
120 Mil Power 500V, 6.3V @ 5 Amp. 5V @ 4 Amp. .... 4.25  
50L6 Output ..... .59  
6V6 Output ..... .69  
8 Watt Universal Output..... 1.29

**2 Post V.M. Record Changer**...\$17.95  
3 for \$52.00

## CONDENSERS

### TUBULAR PAPER CONDENSERS All 600 Volt test

MFD	PRICE EACH	PER 100	MFD	PRICE EACH	PER 100
.01	.08	\$6.50	.001	.08	\$6.50
.02	.08	6.50	.002	.08	6.50
.05	.10	8.00	.005	.08	6.50
.1	.12	9.00	.006	.08	6.50
.25	.17	13.50	.015	.26	22.50

### "ILLINOIS" ELECTROLYTICS

MFD	VDC.	PRICE	MFD	VDC.	PRICE
10	25v	.25	50	150v	.50
100	25v	.55	8	450v	.38
12	50v	.38	10	450v	.43
16	150v	.35	16	450v	.55
20	150v	.38	20	450v	.60
24	150v	.38	40	450v	.88
30	150v	.40	100	15v	.49

### DUALS

16-16	150v	.58	50-30	150v	.76
20-20	150v	.65	8-8	450v	.65
30-30	150v	.70	10-10	450v	.70
40-20	150v	.70	20-20-20	150v	.99

10% discount on all electrolytics if purchased in lots of 20 or more  
Mica Condensers, All sizes 8c each

## RESISTORS

1/4 watt, all sizes..... 2c  
1/2 watt, all sizes..... 3c  
1 watt, all sizes..... 4c  
5 watt wire-wound..... 18c  
10 watt wire-wound..... 20c  
25 watt wire-wound..... 30c  
Resistor kit containing 100 insulated resistors in popular sizes of 1/2, 1 and 2 watt \$1.95

All items subject to prior sale

20% with order, balance C.O.D. We prepay express on \$50.00 orders in U.S.A.

**ELECTRONIC PARTS, Inc., Dept. AI**

622 W. Randolph St. Chicago 6, Ill.

116

truck 3 to 5 or even 8 years, but in a particular business the useful life may vary considerably.

Alterations made by the taxpayer to business quarters which he rents for his business use may be depreciated over the period his lease has to run from the time such alterations were made.

Cars used partly in business and partly for private use may be depreciated, with that part of such depreciation chargeable to business use deductible, the personal part not being deductible, either as a business expense, or as a personal deduction.

In depreciation deductions, the amount claimed must be supported by data called for in depreciation schedules. Taxpayers may not safely, as many now do, merely show the amount of depreciation being taken without showing how they arrived at such annual depreciation. This information must include: the kind of property being depreciated, the date acquired, the cost or other basis used in computing depreciation, the depreciated value at the end of the year, the depreciation allowed or allowable in prior years (even though not previously taken), and the remaining cost or other basis to be recovered, as well as the estimated life used in accumulating depreciation, and the estimated remaining life at the beginning of the tax year being reported.

Any recognized method of accounting practice may be used in computing depreciation, provided the method is used consistently. Once the method

is elected it may not be changed except with the permission of the Commissioner of Internal Revenue. Nor may depreciation for one year be taken in another year. Each year's depreciation must stand by itself, and be taken in the year in which such depreciation occurs.

-30-

## U.H.F. Oscillator

(Continued from page 35)

are no difficult adjustments to be made.

With the condenser soldered across the end of the line, the frequency of oscillation will be about 400 megacycles. When the condenser is soldered directly at the plate and grid terminals at the tube socket, oscillation frequency will be 800 megacycles.

This little gadget is a suitable foundation unit which can be used as the r.f. section of a superregenerative transceiver or simple low powered transmitter. A small modulator of 2 watts output will provide satisfactory phone operation.

Fig. 3 shows how an antenna may be coupled to this oscillator. Coupling may be adjusted by varying the position of the loop and adjusting the screw for capacity variation.

With an oscillator operating at this frequency there is not a great deal of difference in the loaded and unloaded condition.

-30-

## SENSITIVE CRYSTAL VOLTMETER

THE Sylvania type 1N34 crystal diode with a 0-1 d. c. milliammeter makes a sensitive voltmeter for a. c. and r. f. values below 1 volt. The simple circuit diagram of the instrument is given in Fig. 1. A meter of this type is invaluable for fractional voltage measurements in the communications laboratory and for use as an indicator across tuned circuits, in wavemeters, in weak-signal a. f. or r. f. bridges, in conjunction with exploring probes, in field strength meters, modulation meters, etc.—wherever no d. c. component is present and where the relatively low impedance of the diode and meter combination can be tolerated.

The calibration curve appears in Fig. 2. An almost imperceptible vibration of the milliammeter pointer was noticed at 60 cycles and apparently was due to the small back conduction of the crystal diode, but it did not appear to affect the accuracy of the calibration. Experimentation proved that it could not be eliminated by using a larger

meter bypass capacitor than the one shown in Fig. 1.

The voltmeter may be calibrated against some other reliable a. c. voltmeter (v. t. voltmeter or 1000- to 20,000-ohms-per-volt-meter) by means of a source of variable a. c. voltage (0-1, or 0-2 volts r. m. s.), such as the output of a 2 1/2 volt filament transformer taken through a 10,000-ohm potentiometer. For approximate results, the curve given in Fig. 2 may be used in lieu of an individual calibration.

-30-

Fig. 2.

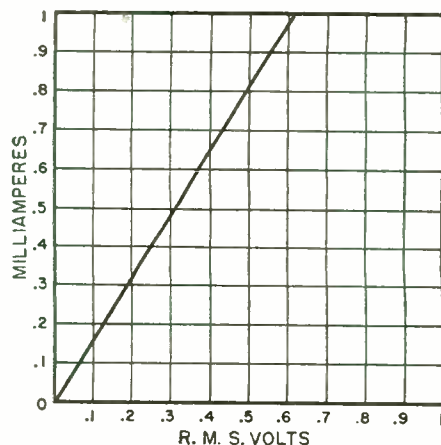
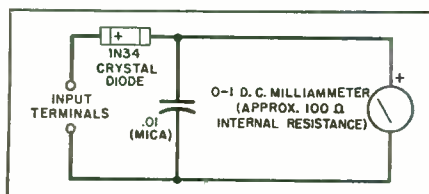

Fig. 1.





# Set Right in Your Own Home!

television mathematics they need. Several students with only grammar school educations have successfully completed advanced technical television courses.

A considerable number of out-of-state students attend the school because of its excellent, practical type of radio and television courses, so difficult to get anywhere else in the world today. Living quarters are obtainable by single students.

## You Put Into Practice Everything You Learn

Students at N.Y.T.I. of N.J. particularly like the way the school puts into practice what it teaches. You may actually build a 17-tube television chassis. You also help build as many as 7 radio receivers of different types, a total of 75 electronic educational devices. Class study, and laboratory study, in the proper combination, increase interest—and your hands get as smart as your head.

A 17-tube, experimental, television chassis may be built by all resident students of television, and may be kept as their own property, if they so choose.

## Located in the Heart of the Electronic Industry

The New York Technical Institute of New Jersey is in Newark, N. J., just across the river from New York City (only 20 minutes from Broadway by subway or train). The school is located in the heart of America's great radio and electronics industry. Such leading television, radio and electronics manufacturers as R.C.A., Western Electric, Du Mont, Federal and Edison are nearby. This means that the school offers numerous advantages, as it is in touch with the most recent developments in radio and television.

Highly qualified television and radio instructors are here in abundance. Equipment is easier to get. Television students are offered exceptional advantages in this great electronic center.



Instructor demonstrating theory of light in connection with study of optical systems used in projection type television receivers. This is just another one of the pieces of equipment which the New York Technical Institute of N.J. has available for resident student instruction.

Big picture television (16" x 21 1/4") in the flesh at N.Y.T.I. of N.J. When it comes to television receivers, N.Y.T.I. of N.J. has it! All types of television receivers are available for student use and instruction at the school.

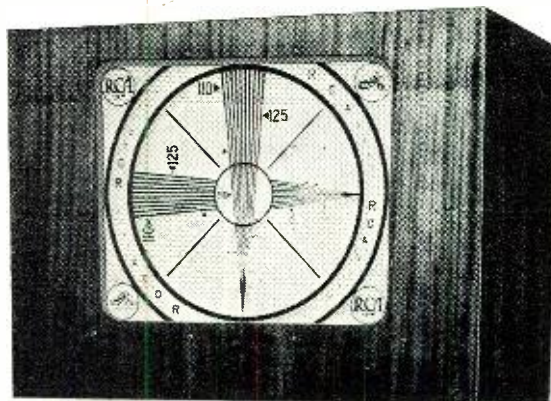

Standard laboratory type test pattern used for determining picture perfection in all types of television transmitters and receivers. (You can see it at N.Y.T.I. of N.J.)

**MAIL THE COUPON  
TO GET FULL  
INFORMATION . . . FREE**

The school issues a special Bulletin which illustrates and describes its truly exceptional facilities and equipment. This Bulletin also describes classes that may be attended, housing conditions, costs, hours, etc. If you are interested in Television—you will want to read this Bulletin. You can have it *free*, merely by mailing the coupon at right.

The school will also be happy to send you complete information about the television kits and directions which are now available to you if you desire to build your own television chassis at home.

Just fill out the coupon at right and mail it NOW to:  
New York Technical Institute of New Jersey, Dept. 11,  
158 Market Street, Newark, N. J.

**New York Technical Institute of New Jersey, Dept. 11,  
158 Market Street, Newark, New Jersey**

Check here if you wish to receive the Special FREE Bulletin describing the resident school of the New York Technical Institute of New Jersey located in Newark, N. J.—including its facilities, equipment, courses offered, costs, hours, etc.

Check here if you wish complete information about building a television chassis in your own home.

Check here if you are a War Veteran.

Name..... Age.....

Address.....

City..... Zone (if any)..... State.....





Where you see

**THIS SIGN**

You can count on

**SERVICE**

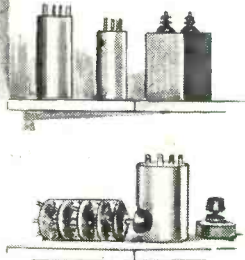

**Y**OUR distributor wouldn't have the Mallory franchise if he were *merely* a distributor of Mallory parts. He was selected because he has a thorough knowledge of the business . . . because he has the *ability* to be of real help . . . because there is no question about his *willingness* to give it.

That's why your Mallory distributor is a good man to know and do business with. Call on him for *any* help within his province—from problems of procurement to problems of management—and you'll find him glad to respond. He's the right man, in the right place, with the right kind of service to save you time and money.

## Here's What Your MALLORY Distributor Will Do For You:

1

A complete line of Mallory replacement parts . . . many of them first developed by Mallory research . . . ALL of them guaranteed against premature failure by years of service in the field.

2

A program of standardization that meets the maximum number of application needs with the minimum number of parts . . . reduces investment, simplifies replacement, speeds up delivery.

3

Efficient service . . . backed by detailed information on prices, parts, catalog numbers . . . promptly shipped whether orders are large or small . . . especially effective in meeting emergencies.

4

Technical service helps . . . bulletins, booklets, catalogs, letters with complete data on what to use and where to use it . . . special publications on radio fundamentals and new developments.

5

A background of personal experience . . . acquired through years of service in radio . . . helpful in solving difficult or unusual problems . . . effective in training dealer personnel.

6

Commercial "know how" . . . implemented by sound methods of keeping your business "on the beam" . . . with special attention to promotion devices that help sell your story to the public.

P. R. MALLORY & CO. Inc.

# MALLORY

VIBRATORS . . . VIBRAPACKS\* . . . CAPACITORS . . . VOLUME CONTROLS . . . SWITCHES . . . RESISTORS . . . FILTERS . . . RECTIFIERS . . . POWER SUPPLIES. ALSO MALLORY TROPICAL\* DRY BATTERIES, ORIGINALLY DEVELOPED BY MALLORY FOR THE U. S. ARMY.

\*Reg. U. S. Pat. Off.

**APPROVED PRECISION PRODUCTS**

P. R. MALLORY & CO., Inc., INDIANAPOLIS 6, INDIANA



# Better Than a Sandwich Man

Put these attractive colored display cards to work for you in your window or on your counter. They carry a terrific impact where competition is keen, where even an old-timer must sell his service over and over again to his community. These cards point up strong reasons for a 6-month radio check-up and show that you employ only new, genuine replacement parts. Display them prominently and business will come to you.

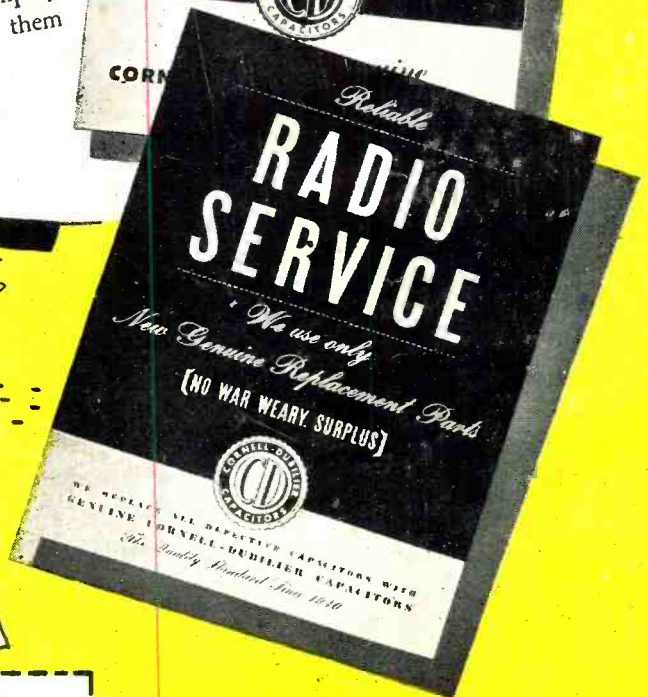
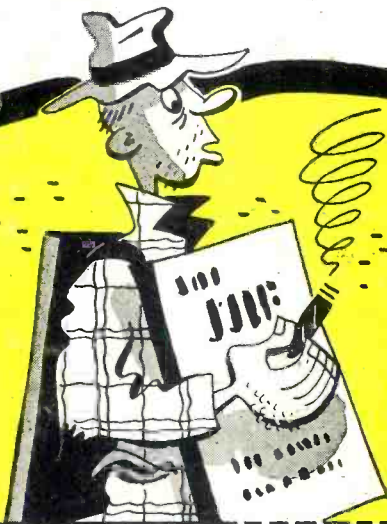

All these sales aids help to make your shop headquarters for radio service in your community.



- NEWSPAPER MATS
- MATCH BOOKS
- COUNTER CARDS
- STATIONERY DECALS
- SHIPPING LABELS
- POSTCARDS
- "C-D CAPACITOR"
- CATALOGS

let yourself grow! See your local C-D jobber today and order these powerful sales builders. Most of them are free. Get on the "C-D Capacitor" mailing list now, write direct to: Cornell-Dubilier Electric Corp., South Plainfield, N. J. Other plants at New Bedford, Worcester and Brookline, Mass., and Providence, R. I.

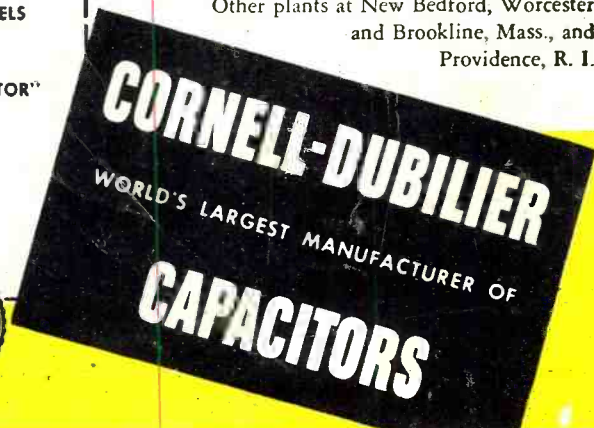

MICA • DYKANOL • PAPER • ELECTROLYTIC

